

September 2023

CAN Newsletter

Hardware + Software + Tools + Engineering



Pressure sensors improve cooling

*CANopen controller for independent metering
control valves*

Vertical farming as a promising future concept

www.can-newsletter.org

Applications

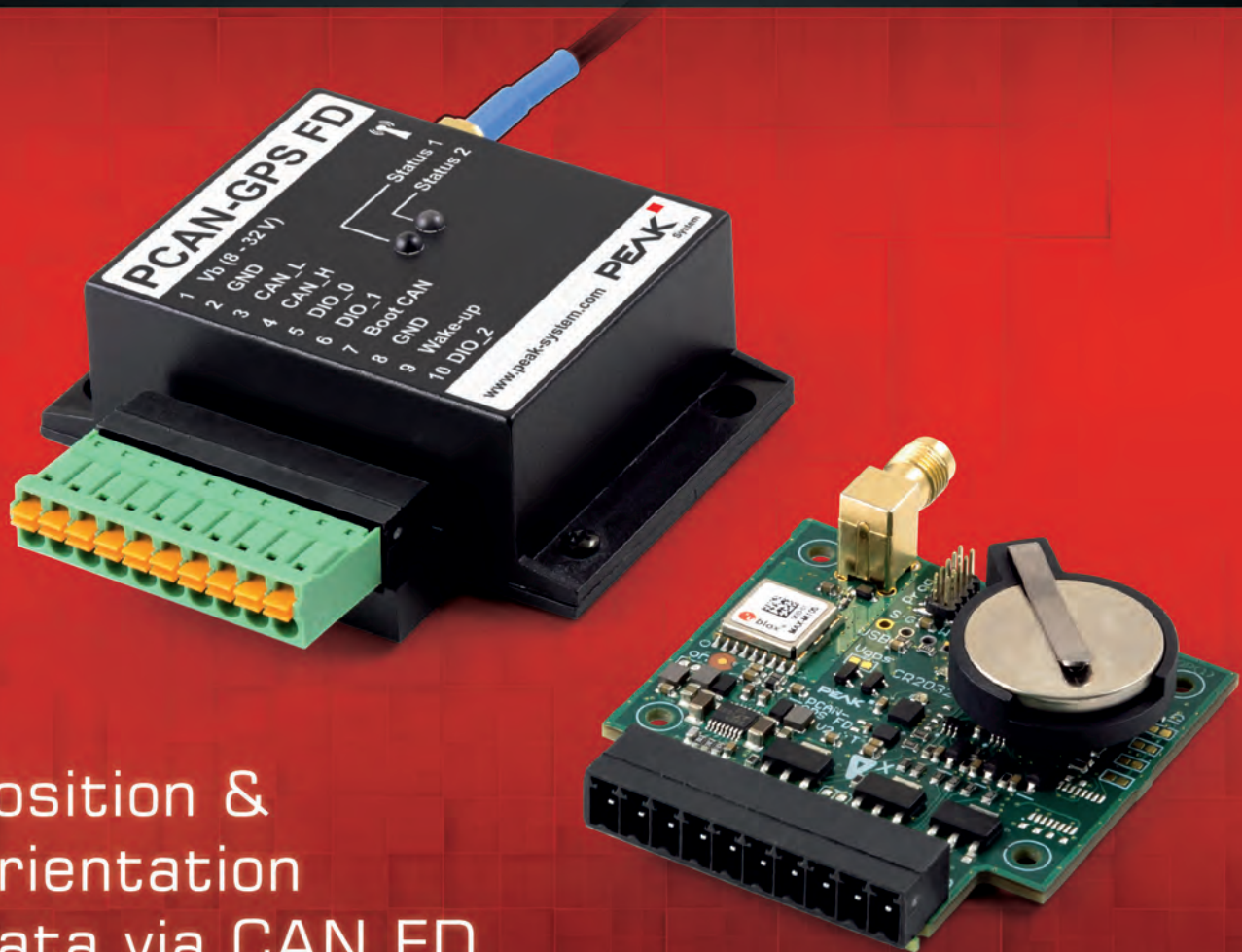

Position & Orientation Data via CAN FD

■ PCAN-GPS FD: Programmable Sensor Module with CAN FD

The new PCAN-GPS FD from PEAK-System is a programmable sensor module for position and orientation determination with CAN FD connection. It has a satellite receiver, a magnetic field sensor, an accelerometer, and a gyroscope. Incoming sensor data is processed by the NXP microcontroller LPC54618 and then transmitted via CAN or CAN FD.

The behavior of the PCAN-GPS FD can be programmed freely for specific applications. The firmware is created using the included development package with GNU compiler for C and C++ and is then transferred to the module via CAN. Various programming examples facilitate the implementation of own solutions.

On delivery, the PCAN-GPS FD is provided with a standard firmware that transmits the raw data of the sensors periodically on the CAN bus.

Specifications

- High-speed CAN connection (ISO 11898-2)
 - Complies with CAN specifications 2.0 A/B and FD
 - CAN FD bit rates for the data field (64 bytes max.) from 40 kbit/s up to 10 Mbit/s
 - CAN bit rates from 40 kbit/s up to 1 Mbit/s

- NXP TJA1043 CAN transceiver
- CAN termination can be activated through solder jumpers
- Wake-up by CAN bus or by separate input
- Receiver for navigation satellites u-blox MAX-M10S
 - Supported navigation and supplementary systems: GPS, Galileo, BeiDou, GLONASS, SBAS, and QZSS
 - Simultaneous reception of 3 navigation systems
 - 3.3 V supply of active GPS antennas
- NXP LPC54618 microcontroller with Arm® Cortex® M4 core
- Electronic three-axis magnetic field sensor ST IIS2MDC
- Gyroscope and three-axis accelerometer ST ISM330DLC
- 8 MByte QSPI flash
- 3 digital I/Os, each usable as input (High-active) or output with Low-side switch
- LEDs for status signaling
- Connection via a 10-pole terminal strip (Phoenix)
- Voltage supply from 8 to 32 V
- Button cell for preserving the RTC and the GPS data to shorten the TTFF (Time To First Fix)
- Extended operating temperature range from -40 to +85 °C (with exception of the button cell)
- New firmware can be uploaded via a CAN interface

The PCAN-GPS FD is expected to be available at the beginning of Q4 2023.



www.peak-system.com

Take a look at our website for the international sales partners. Scan the QR code on the left to open that page.

PEAK-System Technik GmbH

Otto-Roehm-Str. 69, 64293 Darmstadt, Germany
Phone: +49 6151 8173-20 - Fax: +49 6151 8173-29
E-mail: info@peak-system.com

PEAK
System



Applications

Safe passenger traffic in crowded cities	8
Pressure sensors improve cooling	10
CANopen controller for independent metering control valves	14
Galvanic isolated CAN nodes in small satellites	25
Vertical farming as a promising future concept	35

Imprint

Publishing house
CAN in Automation GmbH
Kontumazgarten 3
DE-90429 Nuremberg
publications@can-cia.org
www.can-cia.org

Tel.: +49-911-928819-0
Fax: +49-911-928819-79

Reiner Zitzmann (CEO)
VAT-ID: DE812852184
HRB: AG Nürnberg 24338

Publisher
CAN in Automation e. V.
Kontumazgarten 3
DE-90429 Nuremberg
VAT-ID: DE169332292
VR: AG Nürnberg 200497

Editors
Olga Fischer (of)
Holger Zeltwanger (hz)
(responsible according to the press law)
pr@can-cia.org

Layout
Nickel Plankermann

Media consultants
Julia Dallhammer
Tobias Kammerer
Birgit Ruedel (responsible according to the press law)
publications@can-cia.org

Downloads June issue
(retrieved August 11, 2023)
3995 full magazine

© **Copyright**
CAN in Automation GmbH
The views expressed on CAN Newsletter magazine are not necessarily those of CiA e. V. While every effort is made to achieve total accuracy, neither CiA e. V. nor CiA GmbH can be held responsible for any errors or omissions.



Devices

Selecting the right encoders for safety-related motion control	4
CAN data acquisition: Challenges and solutions	27



Engineering

UDSonCAN – a diagnostic protocol for various CAN applications	18
CAN XL for real-time control and efficient file transfer	21
Functional safety in road vehicles	30
Simplified ordering process for CiA 425 CANopen interfaces	33



Brief news

Standards and specifications	38
------------------------------	----

CAN FD industrielle est arrivé

Since some time, automotive micro-controllers come with on-chip CAN FD controller units. They provide a lot of computing power and are high-end MCUs. These products are qualified for extended temperature ranges and harsh environment usage. Some of them feature multiple CAN FD ports. Many carmakers use already CAN FD networks in their vehicles. There is also a well-established CAN FD ecosystem on the market covering development and diagnostic tools as well as higher-layer protocol stacks for CAN FD communication. Autosar, ISO Transport Protocol (ISO 15765-2/-5), J1939/22, and UDSonCAN are a few keywords.

The non-automotive industry has not yet migrated to CAN FD. But in the last couple of weeks, MCUs designed for industrial applications with integrated CAN FD controllers have been launched by several chipmakers. The CAN Newsletter daughter/sister publication, the [CAN Newsletter Online](#), has reported already about some of these non-automotive MCUs. The CAN FD tools designed for the automotive industry are suitable for other application fields. CANopen FD protocol stacks are available, too. There is no excuse anymore not to migrate to CAN FD in non-automotive applications – with one exception: your application does not need more bandwidth as classical CAN provides and 8-byte data fields are sufficient.

Holger Zeltwanger, editor-in-chief



Selecting the right encoders for safety-related motion control

This article discusses several strategies for implementing redundant feedback channels in motion control systems and evaluates their relative strengths.

(Source: AdobeStock)

For safety-related applications, motion control systems must be able to trust the position feedback that they receive from encoders and other sensors. If a sensor malfunctions, the controller must be able to quickly recognize the fault and take appropriate action. Device failure can be detected more readily if there are redundant feedback channels in the control system. If the control system receives similar signals from two different sensors set up to measure the same mechanical property, it can reasonably assume that both are functioning properly. Discrepancies between the readings would signal a fault.

Enhanced safety through redundant feedback

For safety-related equipment, the motion control system should operate in a fail-safe manner. That is, the system should be able to detect faults in the encoders and other sensors that provide position feedback and take appropriate actions to bring the machinery to a safe condition.

A widely used strategy for ensuring that information from the sensor is trustworthy is to build redundancy into the control feedback loops. For each safety-related action of the machine (e.g. rotation of an elevator's cable drum, movement of a robot's arm, or extension of a crane's boom), two or more semi-independent measurement systems would be installed to monitor the same mechanical motion. This enables the control system to detect sensor errors and avoid dangerous loss-of-control situations.

Duplicating each element of the feedback loop by adding extra encoders and communication cables would achieve this goal, but at the price of extra expense and increased mechanical complexity. The additional devices will also take up valuable space in the complex machinery.

Safety-certified encoders

An alternative is to use special safety-certified encoders. This type of encoder has two measurement modules installed in a single housing, sharing the same input shaft. A signal-processing chip compares outputs from the two modules and – for most devices of this type – shuts down measurements and issues an alarm signal if a discrepancy is detected. Redundancy, in this case, is built into the encoder. Encoders with these characteristics can be designed to comply with safety integrity level (SIL) or performance level (PL) standards (see text box).

An advantage of safety-certified encoders is that they can simplify the development of safety-critical systems. The control system will receive either reliable position data, or a clear signal that the encoder has detected a fault. However, this approach can be inflexible when handling failure situations: if the sensors simply switch off, the control system has little guidance as to how to transition the machinery to a safe state.

Certified devices can be significantly more expensive than 'ordinary' encoders mostly because of the certification cost by an independent testing laboratory. And, while these devices eliminate the need for doubling the number ▶

of encoders installed, they are only available in a limited number of mechanical configurations. Machine builders may be obliged to modify their designs to accommodate these sensors.

Diverse-redundant encoders



Figure 1: Diverse-redundant encoders have two measurement modules built into a single housing, sharing a common shaft. They do not compare the output from the two measurement channels. Both output signals are transmitted directly to the controller (PLC) to be evaluated there (Source: Posital)

This type of encoder introduced by Posital provides a middle ground between complex duplicate encoder installations and expensive safety-certified devices. Diverse-redundant encoders have two measurement modules built into a single housing, sharing a common shaft. However, unlike their SIL- or PL-certified counterparts, diverse-redundant encoders do not compare the output from the two measurement channels. Instead, both output signals are transmitted directly to the controller (PLC, or control computer) to be evaluated there. This arrangement simplifies the machine layout, since there

is only one device to install for each control loop. And, since these devices are not formally certified, they are less expensive than their SIL-rated counterparts. They are also available in a greater variety of mechanical configurations.

An important feature of diverse-redundant encoders is that two different measurement technologies – optical and magnetic – are used for the two measurement modules. This improves diagnostic coverage and reduces the possibility of common-cause failures. Both measurement systems are based on well-established encoder technologies designed to operate reliably over a wide range of temperatures. As well, both measurement channels feature battery-free multi-turn rotation counters for zero-maintenance operations. Diverse-redundant encoders are available with a wide range of mechanical options that include aluminum or zinc-coated steel housings, environmental protection up to IP66/IP67, multiple connector types and a variety of shaft and flange designs.

Diverse-redundant encoders support CANopen communication protocols, with J1939 connectivity under development. The CAN controller would “see” two separate devices, measuring the same rotary motion. The controller is responsible for comparing the measurements and deciding whether they are reliable.

Is device certification a must?

Does the lack of device certification put an extra burden on machine builders to prove the safety of their products? The answer depends on the complexity of the design. Even if ▶

Miniature Pressure Transmitter CMP 8271 **CANopen**

- Small and rugged construction
- CANopen bus protocol DS301/DS404 supports CAN 2.0A/B
- LSS (DS 305 V2.0)



www.trafag.com/H72619

www.trafag.com | trafag@trafag.com

trafag
sensors  controls

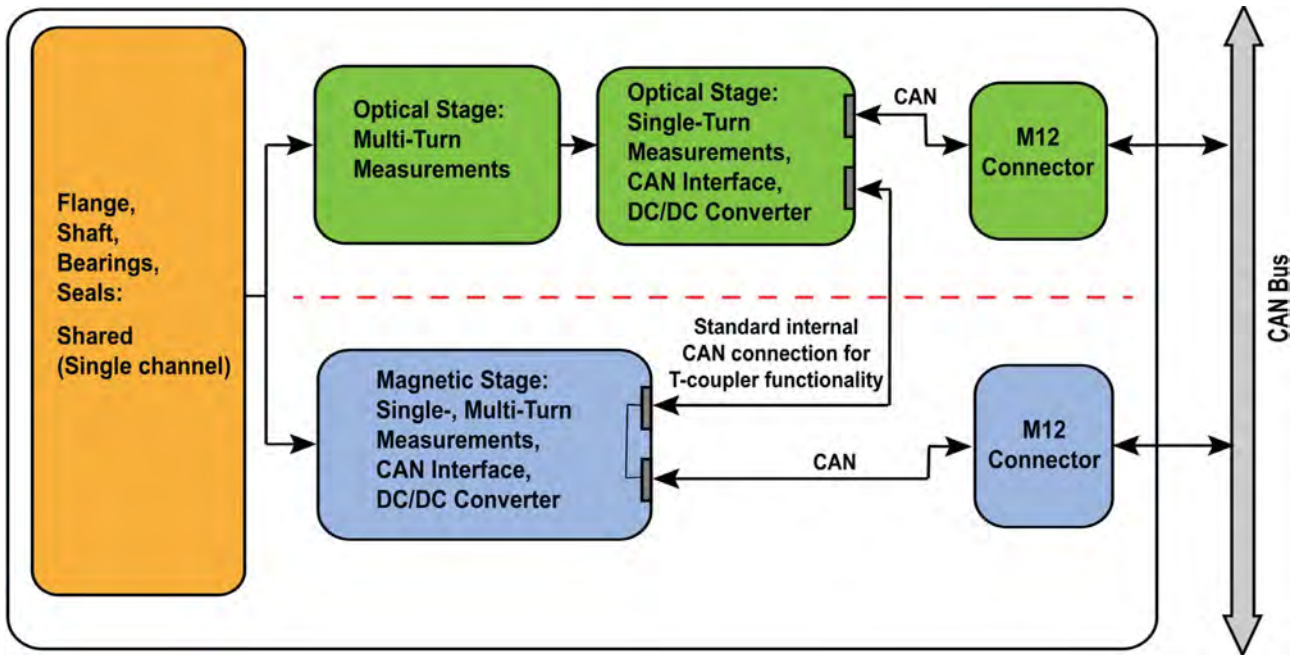

Figure 2: Block diagram of a diverse-redundant encoder (Source: Posital)

certified devices are used in the design, certification of the complete machine requires an end-to-end assessment of the design, including the way in which the control system handles the device failure. Shifting responsibility for fault detection from the device to the controller may require only a minor increase in programming effort.

ISO 13849 allows the use of non-certified redundant devices in safety applications, provided there is an end-to-end assessment of the design. By making the controller responsible for the verification of the two measuring channels, instead of the sensor, the designer has more flexibility in responding to the requirements of the application. If it is possible to determine which channel is faulty through a plausibility check, then the machine could be transitioned to a restricted operational mode, relying on information

from the surviving encoder. If an impact analysis permits, the system can be kept running – possibly with manual override – until the faulty devices are replaced.

Which approach suits for my application?

For simple systems with few motion control feedback loops, the use of duplicate, redundant sensors can be a cost-effective choice.

For on-off or low-volume products developed under tight time constraints, the convenience of working with SIL- or PL-certified encoders (reduced development times, less safety knowledge required) might outweigh the extra cost and limited availability of these devices. For many projects, diverse-redundant encoders can provide

Safety-related standards

There are several international standards that address functional safety in machinery or control systems, including:

- ◆ IEC 61508: Functional safety of electrical/electronic/programmable electronic safety-related systems;
- ◆ ISO 13849-1: Safety of machinery — a safety standard which applies to machinery control systems that provide safety functions.

These standards address different areas of concern and are not always consistent in detail. There are, however, important common themes:

- ◆ While absolute safety is impossible to achieve, including special design features (“safety functions”) can reduce risks to acceptable levels.
- ◆ The need for special safety functions depends on both the probability of something going wrong and the potential consequences of an accident/failure.
- ◆ To be effective, safety functions must meet reliability standards (performance levels or safety integrity

levels) that are appropriate to the level of risks and consequences.

In ISO 13849-1, the level of reliability required for a safety function is defined in terms of a performance level, ranging from PL a to PL e. If, for example, an accidental malfunction could cause a serious injury to a person who frequently works close to a piece of machinery, the standard requires that the machine and its safety systems have a performance level of at least PL d. To achieve this performance level, the MTTF (mean time to dangerous failure), DC (diagnostic coverage) and Cat. (system architecture category) must all reach defined thresholds.

In IEC 61508, performance requirements are defined in terms of safety integrity levels (SIL), ranging from SIL 1 (for situations with low risk and moderate consequence) to SIL 4 (high risk, serious consequences). SIL 2 is approximately equivalent to PL d and requires a similar level of reliability in safety functions.

a best-of-both-worlds solution. There is only one device to mount on the machine, reducing complexity and space requirements. Meanwhile, the two independent measurement channels provide a sound basis for building machines that can be certified to PL d, Cat. 3, according to ISO 13849-1.

With duplicate feedback loops or diverse-redundant encoders, the control system might be able to use other system knowledge to make a reasonable assessment as to which of the redundant measurement system is malfunctioning and whether the surviving system can be relied on to provide useful position data. In this case, the designer might be able to implement a restricted operating mode to extend the availability of the machine for a limited time. In any case, replacement of the defective device would be an urgent priority. ◀



USB-to-CAN FD
for CAN and CAN FD

PC/CAN INTERFACES

Easy CAN and CAN FD connection
for your application

- Interfaces for configuration, analyzing and control applications as well as for the Ixxat tool suite
- All PC interface standards supported with one uniform driver – easy exchange without programming!
- Drivers (32/64 bit) for Windows7/8/10/11 and Linux
- API for CANopen



Discover more:
www.all4CAN.com



CAN-IB 640/PCIe
4 x CAN, CAN FD



CAN@net NT 420
Ethernet PC Interface,
Bridge, Gateway
4 x CAN, 2 x CAN FD



CAN-IB 120/520/PCIe Mini
1-2 x CAN, CAN FD



CAN-IB 230/630/PCIe 104
2-4 x CAN, CAN FD



CANblue II - Bluetooth
PC Interface, Bridge,
Gateway, 1 x CAN

Author



Klaus Matzker
Posital
Klaus.matzker@fraba.com
www.posital.com



Safe passenger traffic in crowded cities

Urbanization is an ongoing megatrend. On the one hand, it leads to the emergence of new mega-cities as economic and innovation centers. On the other hand, it causes increased environmental pollution and congestion of the existing transport infrastructure.

Digital technologies and automated traffic systems help to manage increased passenger traffic in public transport buildings in a smart and safe way. Thus, accidents can be avoided, and the existing infrastructure can be maintained.

Access control systems play an important role in these developments. In urban areas, public buildings such as office complexes, shopping centers, train and bus stations are visited and used by countless people every day. To reliably ensure security in these congested areas and prevent unauthorized access both during rush hours daytime and at night, more and more access control systems are being deployed. When thinking about the recent staffing problems at European airports, the need for this technology becomes even clearer.

To operate those automated access systems, appropriate drive solutions are required. These must be characterized by robustness and implemented safety functions.

Drives for automated access systems

Dunkermotoren, a brand of Ametek, has been a global expert in motorized building automation for many years. Besides brushed or brushless motors as part of the drive concept, motor control and communication capabilities are increasingly gaining on importance. The motor controller (or drive) is the electronic device, which enables, for example, an automated access system to respond to different scenarios. In the motor controller, a variety of motion profiles can be parameterized, or customer-specific object detections can be programmed. This allows manufacturers to differentiate the movement behavior of their door leaves.

Using the Motioncode programming environment, the control logic of the Dmove and Dpro motor series, for example, can be programmed in C and is accommodated directly on the motor. The communication capability enables exchange of data and parameters with other controllers and devices, or reports occurring events (e.g. a blockage) to a higher-level system.

CANopen and CiA 402 support

All Dunkermotoren motors with integrated electronics support a CANopen interface. CANopen offers an open, standardized, and cost-effective interface for communication with external devices and controllers. The implemented support of the CiA 402 device profile for drives and motion control allows to access the motor parameters and further operation data via a CANopen network in a standardized



Figure 1: The Dunkermotoren motors used in access control systems provide CANopen connectivity (Source: Dunkermotoren)

manner. Thereby, acyclic reading and writing access via SDOs (service data objects) and cyclical access via PDOs (process data objects) is possible. The CANopen network can be used to parameterize a motor initially, e.g., for the assignment of the node-ID and bit rate via the LSS (layer setting services). The network is also used to send new commands such as movement instructions to the motor or to receive the status and current parameters from the motor during operation. The readout of operating data and events programmed in the motor controller enables further functionalities such as condition monitoring or predictive maintenance.

Implementation according to EN 17352

With the IIoT (industrial Internet of Things) brand Nexofox, the manufacturer offers solutions for analysis and use of the motor's operation data. Via CANopen, the motor operation data can be read out and further processed and evaluated locally or in the cloud. For example, the recorded motor data allows to draw conclusions about the current wear state of the mechanical drive train. The Nexofox devices support the communication setup with the motor, programming of the motor control using the Motioncode tool, and data integration in the cloud.

The combination of integrated motor control, communication capability, and supportive services offers new approaches for realizing applications compliant with new standards or safety concepts. For example, the recently

published EN 17352 standard specifies the safety-in-use requirements for the power-operated pedestrian entrance control equipment. It only allows to deploy control units, which are operating in accordance to the Performance Level D in Category 3 as defined in the ISO 13849-1. Dunkermotoren offers integrated as well as external control solutions fulfilling these requirements already in the standard version. The implemented safe torque off (STO) function ensures the drive unit to be switched torque-free in fractions of a second. This function is protected by hard-ware redundancy and ensures that neither people are injured, nor objects are damaged in case of an emergency. ◀



Author

Tobias Johnston
 Dunkermotoren
info.dunkermotoren@ametek.com
www.dunkermotoren.de

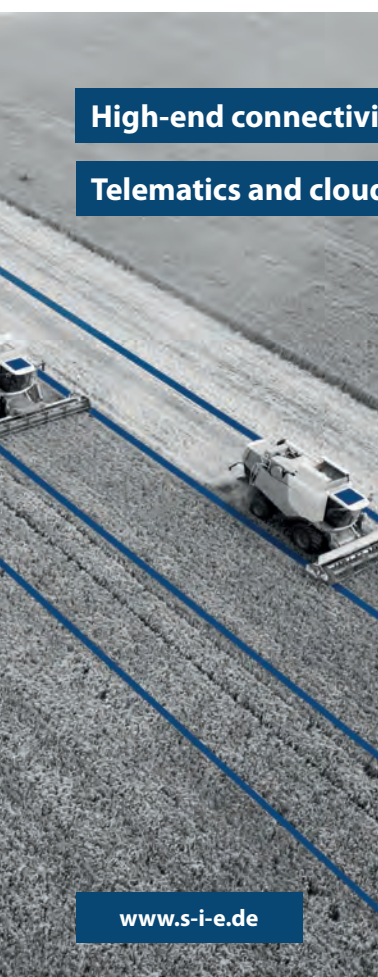

High-end connectivity with CAN and CAN FD

Telematics and cloud systems for IoT and Service 4.0

www.s-i-e.de



On-board units – from cost-saving entry telematics up to high-end modules. Including updates-over-the-air, embedded diagnostic functionality and up to 4x CAN channels (CAN FD).

Off-board units – new high-end service VCI with Linux operating system, IoT functionality and LTE mobile communication

Cloud solutions – IoT Device Manger | IoT Analytics Manager | Fleetmanagement. Out of the box data mining and data logging – highly secure, comfortable and customizable.

IoT ECU – COMhawk® xt



4x CAN, J1939, LTE, Wi-Fi, Bluetooth, LAN, GPS, I/Os



Integrated flash-over-the-air functionality



Multi-protocol support (J1939, J2534, UDS, KWP, ...)

IoT VCI – COMfalcon® IoT



4x CAN, J1939, LTE, Wi-Fi, LAN



High-End Vehicle Communication Interface



Multi-protocol support (J1939, J2534, UDS, KWP, ...)

Pressure sensors improve cooling

Refrigeration is vital to ensuring the shelf-life of food. The need for cooling became even more urgent for the distribution of Covid vaccines. Pressure measurements are helping refrigeration evolve.



(Source: ReigenT, Keller Meettechnik)

Refrigeration is a broad sector and includes the following:

- ◆ Appliances for retail and commercial applications;
- ◆ Medical coolers and refrigerators;
- ◆ Domestic refrigerators and freezers;
- ◆ Air conditioners and heat pumps.

All of these appliances use coolants or refrigerants in their cooling systems or heat pumps as a means of transporting heat. Developing these refrigerants is paramount as they have a significant impact on the environment.

In the past, the use of synthetic refrigerants known as chlorofluorocarbon refrigerant gases (CFCs), and later hydrochlorofluorocarbon refrigerant gases (HCFCs), caused a large hole to form in the ozone layer. Both were banned, and have since been replaced by less harmful refrigerants. The hydrofluorocarbon refrigerants (HFCs) are free from environmentally damaging chlorine-based components, but even these still contribute to global warming. Whereas refrigerants used to be measured in terms of their ODP (ozone depletion potential), HFCs are evaluated

based on their GWP (global warming potential) – a relative measure that assesses the impact of a greenhouse gas based on its contribution to global warming as compared to carbon dioxide (CO₂).

Natural refrigerants research

Carbon dioxide has a GWP value of 1, while the GWP value of a HFC can be between 124 and 22 800 times higher. This means that leakages of carbon dioxide, which is a naturally occurring refrigerant, result in a much less pronounced greenhouse effect, making carbon dioxide an ideal alternative to synthetic agents. The drawback of using CO₂ is that it creates extremely high pressure in refrigeration systems, resulting in low efficiency.

Other natural refrigerants, such as isobutane or propane, have the downside of being flammable. In the United States of America, people did not want to work with flammable refrigerants for a long time, which is why most research has focused on CO₂-based solutions. Given that ▶

Specialized in testing refrigerators

One of the key factors in terms of sustainability in refrigeration is the choice of refrigerant. Based in the Dutch city of Helmond, Re/genT is a company that specializes in testing refrigerators, and is deploying its test systems to make the coolants used across the refrigeration engineering sector more cost-effective.

The name Re/genT is an abbreviation that stands for "Refrigeration related to the Global Environment and Technology". Johan Wijnstekers is one of the four owners of the company and is responsible for its test systems production department. His team specializes in researching and developing test systems for refrigeration and heat pumps. The company carries out its own in-house tests to the applicable testing standards, and also has its own research and development department for developing products and software.

the priority in research and development is on energy consumption, however, manufacturers stateside are slowly switching to using flammable refrigerants for products such as domestic and small commercial refrigerators. Switching from HFCs to HCs (hydrocarbons) requires a lot of development work, and not just in terms of safety.

Energy consumption and the environmental impact of the refrigerant are indicated with a TEWI (total equivalent warming impact) value. The following three factors can influence energy consumption:

- ◆ The compressor extracts heat from the appliance;
- ◆ Insulation can be applied in various thicknesses and types;
- ◆ A good heat transfer ensures the smallest possible temperature/pressure difference between the cold and hot side of the cooling system, which reduces how much energy the compressor consumes.

Regulating the TEWI value makes it possible to develop creative solutions for any application in the field of refrigeration engineering.

Testing standards

The Dutch company Re/genT is a developer of energy-efficient solutions in refrigeration engineering. The company is also involved in testing and verifying energy labels and ecodesign requirements.

Over time, it became clear that refrigerators behave differently under standard test conditions than in daily use. Whereas testing used to be conducted at a single ambient temperature of +25 °C, the manufacturer currently tests at two different temperatures of +16 °C and +32 °C. The differences in the test results obtained at both temperatures make it possible to provide realistic evaluations of daily energy consumption.

Historically, testing has been carried out to different country-specific standards across the world. IEC standards have made sure that testing is now conducted under the same conditions worldwide, which ensures ►

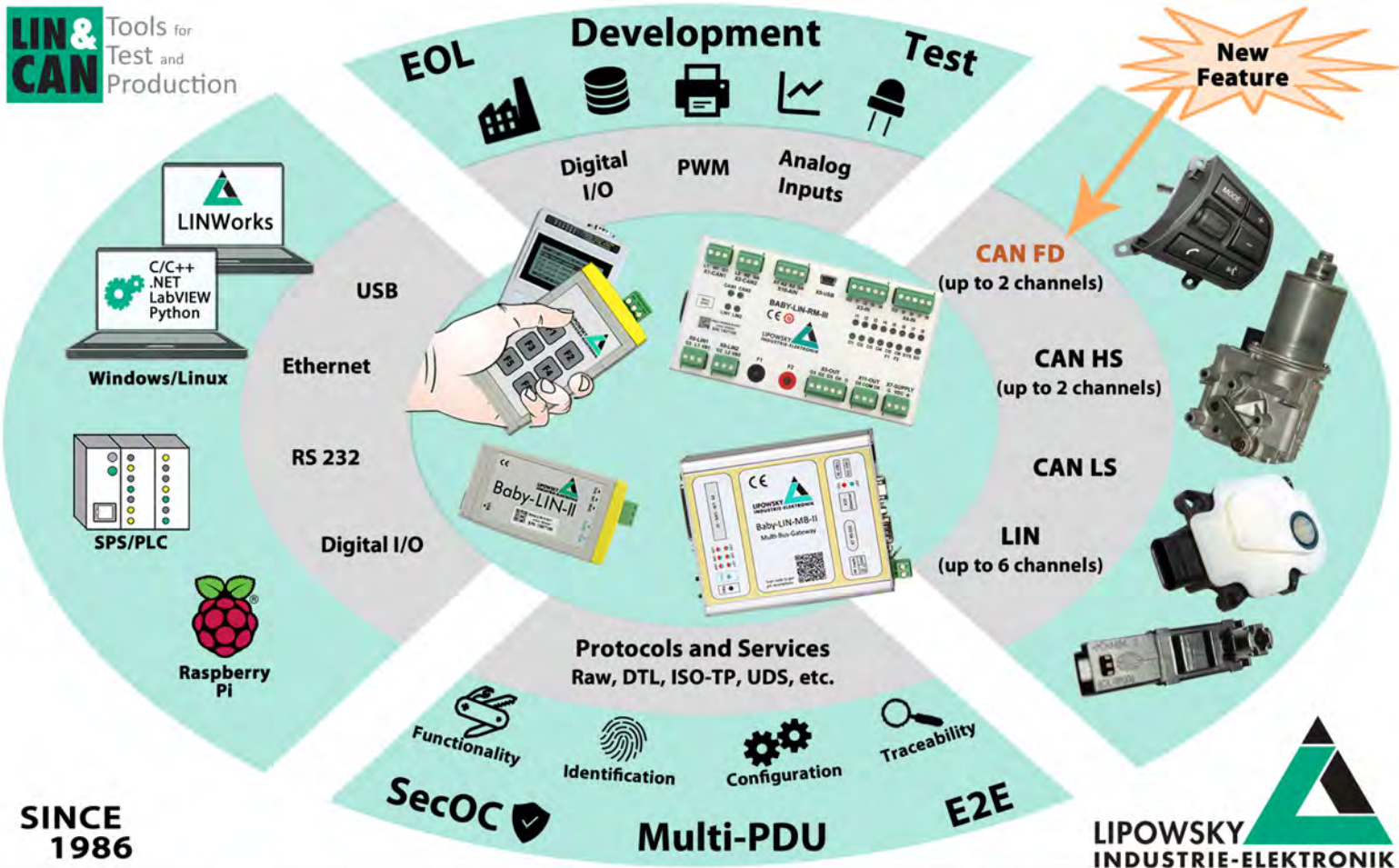

SINCE
1986

www.lipowsky.com

info@lipowsky.de

+49 6151 93591-0

ISO 9001 : 2015

Distribution China: Hongke Technology Co., Ltd
Distribution USA: FEV North America Inc.

Ph: +86 400 999 3848
Ph: +1 248 293 1300

sales@hkaco.com
marketing_fev@fev.com

www.hkaco.com
www.fev.com



Figure 1: Re/genT uses measurement and control equipment to assess how a compressor and its electronic components can be further optimized (Source: Re/genT, Keller Meettechniek)

the comparability of results. Re/genT is ISO/IEC 17025 accredited.

Measurement laboratory

Re/genT has 13 temperature- and humidity-controlled climate chambers. Some of them are designed to hold a single refrigerator, while others are larger. The company's measurement laboratory features every type of test setup and system used by manufacturers, including compressor calorimeters, test benches for heat exchangers, evaporators, condensers and secondary refrigerants, a test bench for air-to-air heat pump systems and an air conditioning test bench for portable air conditioners. It is essential that all of these devices provide highly accurate and repeatable test results.

The company has used Keller sensors in its measurement lab for over a decade. This began when Bosch explicitly asked Re/genT to use Keller's piezoresistive pressure transmitters. The combination of cost-effectiveness, quality, and high accuracy impressed the Dutch company and earned Keller a permanent place in Re/genT's measurement lab.

Different sensors are used for the various test devices. The 33X series is Keller's flagship high-precision



Figure 2: Johan Wijnstekers in front of the test system (Source: Re/genT, Keller Meettechniek)

piezoresistive transmitter with digital communication via EIA-485 (Modbus compatible). Digital communication is vital in order to read the test values and display them in the company's proprietary software. The 23SX series is another commonly-used sensor with CANopen connectivity (see insert). It is welded, which means that it has no internal O-rings, and is therefore suitable for use with all AISI 316L stainless-steel compatible media. The M5-HB pressure transmitter is used to take certain specific measurements. This matchstick-sized sensor has a bandwidth of 50 kHz.

Measuring and testing

Improvements are being made to a number of devices in order to continue reducing energy consumption even further. Compressors, for example, are becoming more and more efficient. The current most widely used speed-controlled compressor can boost the efficiency of the refrigeration system as a whole. Varying the speed minimizes the pressure difference across the compressor, which maximizes its efficiency. Also, the electric motors that power the compressor are becoming more efficient. Modern brushless DC electric motors used in speed-controlled compressors have far fewer losses than induction motors.

Re/genT uses measurement and control equipment to assess how a compressor and its electronic components can be further optimized, both in terms of noise and energy. For example, when a ventilator blows a little stronger, the heat exchange improves. But blowing too strongly uses up more energy, so determining the optimal blowing speed is a precise undertaking.

Insulation is another area in which progress can be made. Thicker insulation and various alternatives to classic insulation are being tested, as are vacuum insulation panels, and different types of foam. Researchers can vary both the raw materials that the foam is made from, as well as the gas used as the foaming agent. Heat transfers more efficiently when the temperature fluctuates as little as possible between the air and the evaporator or condenser. This is another area in which developments in refrigeration engineering are constantly seeking to improve on what was previously considered optimal.



CANopen pressure sensor

In the 23SXc pressure transmitter series, temperature dependencies and non-linearity are compensated by means of a mathematical model in the micro-controller. With the CANopen interface, Keller offers an accurate pressure transmitter that is suited for a wide variety of automation solutions. The welded construction without internal seals is suitable for dynamic applications. Only the stainless steel is in contact with the media.

The product complies with the CiA 404 version 1.2.0 CANopen device profile for measuring devices and implements a CAN high-speed transceiver as specified in ISO 11898-2.

What comes next

Re/genT currently sees the rise of heat pumps as a realistic prospect. While costs will fall, a lot of knowledge is still needed to further optimize heat pump systems. The company is working in this area. When it comes to cooling, it is likely that natural refrigerants will be used more and more for this purpose. All domestic refrigerators in Europe already contain the natural refrigerant isobutane, but it is still being developed for use in other cooling systems and heat pumps. The recent introduction of an energy label for commercial and retail refrigeration systems will also lead to energy savings.

An EU-funded bottle cooler project, in which Re/genT is involved, leads to energy savings, too. "In this project, the cold is stored in what is called a 'phase-change material'. We just use ice in this case, which absorbs a lot of heat when it defrosts and thereby ensures that the system can handle high peak demands. This in turn makes it possible to use a very low-power compressor, which gives us a very efficient cooling system with excellent heat transfer and very low differences in pressure across the compressor. All of this, together with all sorts of other adjustments such as improving the insulation used for the fridge door, helped us to reduce our energy consumption by no less than 75 %", explained Johan Wijnstekers, Head of production department of test systems and co-owner from Re/genT. ◀

Author

Janet Kooren
Keller Meettechnik
info@keller-pressure.com
www.keller-pressure.com



www.esd.eu

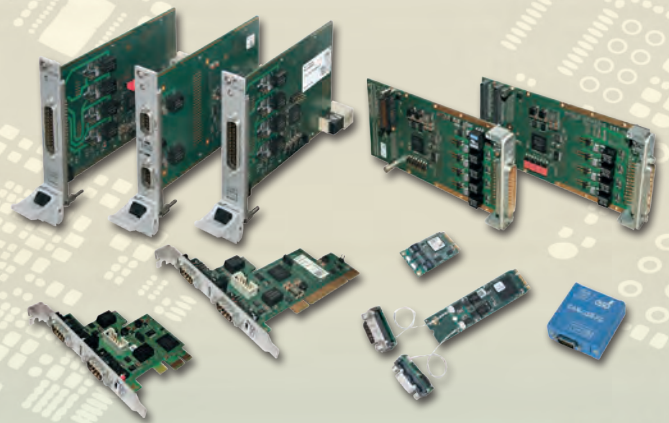

CANopen^{FD}

CAN^{FD}

CAN FD-Interfaces

Various Form Factors

- PCI, M.2, PCI Express[®] Mini, PCI Express[®], CompactPCI[®], CompactPCI[®] serial, XMC/PMC, USB, etc.

Highspeed FPGA Design

- esdACC: most modern FPGA CAN-Controller for up to 4 channels with DMA

Protocol Stacks

- CANopen[®], J1939 and ARINC 825

Software Driver Support

- Windows[®], Linux[®], optional Realtime OS: QNX[®], RTX, VxWorks[®], etc.

esd electronics gmbh

Quality Products -
Made in Germany

Vahrenwalder Straße 207

D-30165 Hannover

Tel.: +49(0)511 372 98-0

info@esd.eu

www.esd.eu

sps November 14-16, 2023
Hall 5 – Booth 131

smart production solutions

US Office: www.esd-electronics.us

CANopen controller for independent metering control valves

(Source: Adobe Stock)

CiA 408 defines the CANopen-based control interface for valves including device state management, control signals, and common device parameters. This article introduces CiA 408, describes a valve controller deployment, and discusses deployment with experiences from real-system projects.

CANopen is the most flexible and widely used system integration framework for generic machinery automation applications. There have been many CANopen valves in the market from the late 90's, but the hydraulic part of such has been limited to the use of a single-spool only. The constrained offering has reduced spreading of the use of modern, distributed controls utilizing integrated valve controllers with standardized interfaces.

This article begins with a brief introduction to the hydraulic valve structures, followed by an introduction of the CiA 408 device profile. Next, a review of the existing CiA-408-compliant valves and PLCs (programmable logic controllers) is provided. After the state-of-the-art, the controller deployment is described. The summary of the deployment with

experiences from real-system projects is provided and future enhancements are listed in the discussion.

Flexible support for hydraulic structures

Hydraulic valves in machinery applications have typically been optimized for each purpose by a variety of structural options, such as different sizes and kinds of main spools. Supplemental valves have been required to enable e.g. adjustable counter-pressure. The main reason for the use of such options is to reach the control accuracy, stability, and response-time performance required by the applications. The traditional approach leads to simple valve structures in simple applications, but the complexity

increases significantly along the increasing performance requirements. There exist also twin- and quad-spool valves in the market for the most demanding purposes, but such do not support a standardized control interface and thus such are not drop-in compatible with the mainstream valves and have been considered complex to use [1].

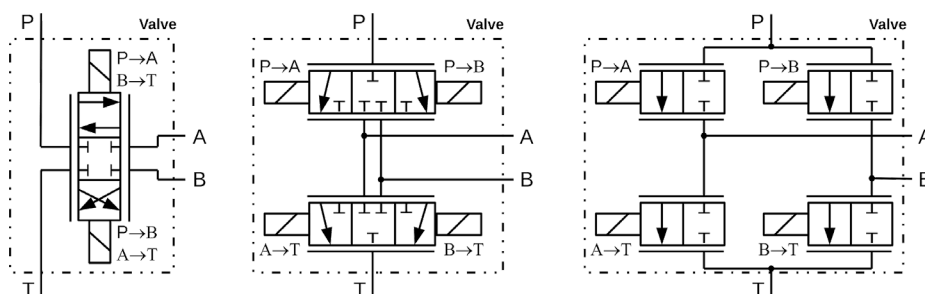

Figure 1: Examples of single- (left), twin- (middle), and quad-spool (right) valve structures (Source: TK Engineering)

Figure 1 introduces different valve structures. Hydraulic interfaces are equal in all valve structures and the difference is in the control behavior. There are four so-called control edges, supply pressure (P) to work port A and B, and from ports A and B to the tank (T). In a traditional single-spool valve all edges are tightly coupled with each other, which limits the achievable behavior. In twin-spool valves, meter-in and meter-out may be independently controlled for both directions [2]. There are still constraints, e.g. by means of flow capacity. Each control edge is independent of the other in quad-spool independent metering control valves [3]. Such provide excellent adaptability, but the control of such has traditionally been left to the system integrators, which have typically considered the controls too complex and thus have not used such valves. This article presents a solution for that problem.

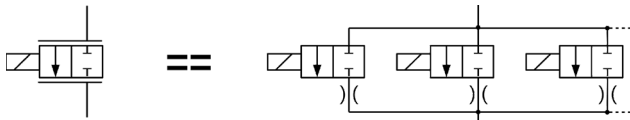

Figure 2: A proportional valve may be replaced with series of on/off valves (Source: TK Engineering)

Another topic is, how to implement proportional behavior of a valve. Traditionally proportional valves were used, where valve opening is proportional to the coil current. There are many unwanted characteristics, why so-called digital valves have been introduced. Such consist of parallel connected on/off valve elements [4]. Main advantages are simple control and stable behavior, when compared with proportional valves. However, system integrators have considered control of many valve elements instead of one a problem. This article presents a solution also for this problem.

Standardized valve control interface

The most commonly supported standardized control interface is defined field-bus independently by VDMA [5] and mapping of it into CANopen is covered by CiA 408 device profile [6]. The VDMA standard and the CiA 408 specification define the core control interface consisting of a device state management, control signals, and the most common device parameters. A block diagram is shown in Figure 3. State management concentrates on a managed error reaction and recovery according to the requirements of the machine directive. Harmonized control signals enable simple application development – the valve control interface does not depend on the valve supplier, model or version and the control applications may use always the same integration approach and signaling. Furthermore, harmonized set of key parameters simplifies significantly the management of adapting valves to operate in their target positions according to the system requirements. One of the most significant features is a possibility for integrated factory calibration. Such may be utilized so, that the valves are calibrated in the factory and may just be installed in the assembly lines. The drive currents versus spool positions of old-fashioned analog valves without integrated controllers have always to be calibrated with the connected controllers after the assembly and service actions. This decreases the assembly and service efficiency and makes

the resulting accuracy dependent on the skills of the calibrating person, time, and tools available.

Also, the design data management becomes easy and reliable according to the use of integrated controllers. Key parameters may be defined during the design phase and stored into the CANopen network project based on standardized files ([7], [8], [9]). Such files can just be provided to assemble and service, where the target position specific parameters may just be stored to the valves. The use of such approach with proper tools is efficient and helps in avoiding the human mistakes.

Off-the-shelf CANopen valves

The use of the off-the-shelf valves supporting standardized control interfaces simplifies and speeds up the designs significantly. The use of the device state machine improves the overall functional-safety performance and leads into the use of a uniform approach for managed valve drives. As shown in Figure 3, control word and setpoints provide redundant signal paths for shutting off the valve in a case of emergency. When compared with the valves with coils only, network-equipped valves consist of integrated lowest level controls, which don't need to be implemented and approved in the application softwares project. Major advantages of such are the support of a control interface independent of the valve-specific structure and integrated support for factory calibration of the valves.

Off-the-shelf controller platform

IEC 61131-3 compliant control application provides flexible support of target hardware [10]. The support for digital valves requires support for higher number of outputs than traditional single-spool valves. Thus, a typical mobile PLC (programmable logic controller) is an attractive platform for independent meter controls. The use of the standardized programming languages makes it easy to intrinsically support for many alternative PLCs with different processing performance and number of outputs. Independence on the hardware is an excellent tool for coping with the potential hardware scalability, availability, and obsolescence problems.

Independent meter control valve controller

The valve controller follows the CiA-408 compliant structure illustrated in Figure 3 ([5], [6]). Device control consists of the device state-machine taking care of managed start-up, error, and error recovery behavior. It ensures that the valve operation will be intentionally enabled after power-up and that error recovery does not lead into an unintentional behavior. The state machine is controlled by a “control word” and its current state is available as a “status word”.

Program control takes care of managing the control mode in use and mode-dependent selection of the setpoints. In a case of this implementation, open-loop spool position control is in use. Because of the valve structure flexibility, both flow and pressure setpoints are supported. They affect the meter-in and meter-out valves according to the flow direction.

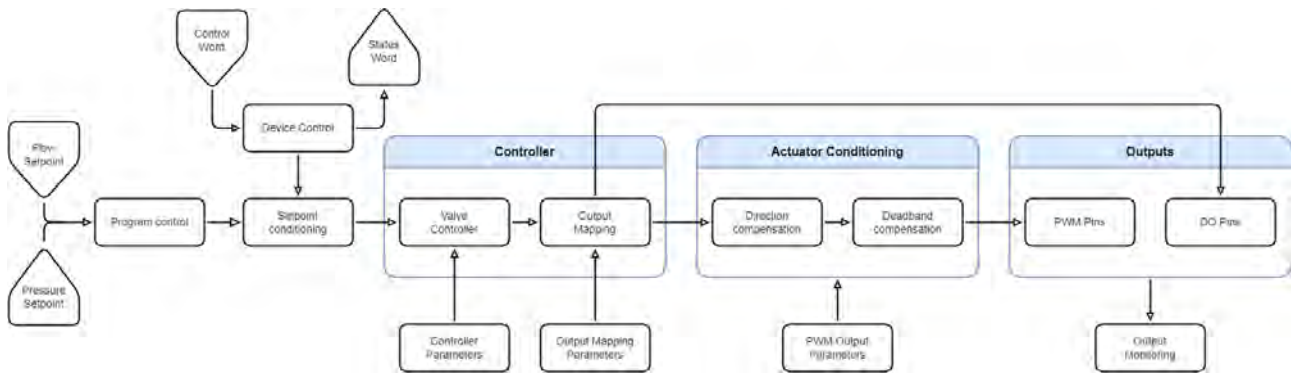

Figure 3: Valve controller block diagram based on CiA 408 device profile (Source: TK Engineering)

Setpoint conditioning implements only the setpoint enabled, based on the device state machine. Open-loop setpoints represent spool openings between -100 % and +100 % for flow and between 0 % and 100 % for pressure. Flow setpoint effects on meter-in control edge and pressure setpoint on meter-out control edge by taking care of the given flow direction.

The controller part implements the valve control behavior of the valve units according to the defined valve structure parameters. Each valve element may be a proportional valve or a “digital valve” – a set of parallel on/off valves [4]. The number of parallel valves may vary from 1 to 8, depending on the constraints set by the underlying hardware. The structure of each control edge may be defined independently of each other in order to provide maximum flexibility for the hydraulics. The controller also implements a configurable output mapping. It implements flexible mapping of each controller output into a corresponding output pin. Such enables flexible usage of the underlying hardware and support of practically any hardware supporting enough PWM- (pulse-width modulation) and on/off-outputs.

The controller is followed by the controller output conditioning. On/off-output signals are used directly. PWM-outputs shall support calibration of minimum and maximum output currents to drive the attached valve elements in an optimal way. Modulation frequency and dither settings are typically implemented by the platform runtime or hardware-vendor-specific libraries. Output status is provided for troubleshooting purposes.

Discussion

A CiA-408 compliant controller ([5], [6]) for independent metering control valves has been developed. It supports the device state machine enabling well-managed start-up, error reaction, and recovery. Open-loop spool position control mode has been deployed for both flow and pressure. Device-profile-specific standard parameters have been used for device control, program control, and controller output conditioning. Only the controller parameters are product-specific. The device profile compliance is important, because from the interface perspective the controller is drop-in interchangeable with the traditional single-spool CANopen valves in the market. Such provides excellent opportunity to system integrators to solve their hydraulic control problems by selecting an optimal hydraulic part and commit into CiA 408 device profile specific control inter-

face. As a result, any hydraulic function in a system may be controlled by using the same, standardized approach independently of the hydraulic-valve structure.

The developed controller supports any combination of on/off or proportional valves. The only limitation is, that either a set of on/off valves, also known as a digital valve or a proportional valve shall be selected for a control edge, such cannot be mixed. It has already been evaluated in real-system projects, how freely the hydraulic structure of a valve may be selected. It has also been evaluated, that the valve element configuration may be adjusted any time during a system development project without causing any additional problems. Vice versa, such ability for valve structure optimization improved the overall project efficiency. All changes were made without a ▶

References

- [1] Sitte A., Weber J., Structural design of independent metering control systems, The 13th Scandinavian International Conference on Fluid Power, SICFP 2013, June 3-5, 2013, Linköping, Sweden
- [2] Rath G., and Zaev E., Cylinder Pressures in a Position Controlled System with Separate Meter-in and Meter-out, The 13th Scandinavian International Conference on Fluid Power, SICFP 2013, June 3- 5, 2013, Linköping, Sweden
- [3] Kolks G., Weber J., Getrennte Steuerkanten für den Einsatz in stationärhydraulischen Antrieben, O+P Fluidtechnik, 6/2018, pp. 42-51
- [4] Heybroek K., On Energy Efficient Mobile Hydraulic Systems, Linköping Studies in Science and Technology, Dissertations, No. 1857, 103 p.
- [5] Profile Fluid Power Technology, Proportional Valves and Hydrostatic Transmissions, Version 1.6.2, Verband Deutscher Maschinen und Anlagenbau e. V., 2010, 121 p.
- [6] CiA 408 device profile for fluid power technology proportional valves and hydrostatic transmissions, Version 1.5.3, 2012, CAN in Automation (CiA) e. V.
- [7] Saha H., Improved management of CANopen-based distributed control systems, Proceedings of the 2nd MMC, CAN in Automation (CiA) e. V., 2015
- [8] Saha H., Accelerated transfer of CANopen projects into assembly and service, CAN Newsletter 4/2012, CAN in Automation (CiA) e. V., pp. 16-20
- [9] Saha H., CANopen in series production, CAN Newsletter 3/2015, CAN in Automation (CiA) e. V., pp. 8-11
- [10] John K-H., Tiegelkamp M., IEC 61131-3: Programming Industrial Automation Systems, Springer Verlag, 1995, ISBN 3-540-67752-6

need for changing system control application or system level parameters.

Configuration management is as easy as with any other CANopen device. Device integration interface with default values is described as a standard EDS file (electronic data sheet), which is a proven mechanism to communicate the data from device supplier to the system integrator. The entire configuration may be managed as a DCF file (device configuration file), from which it may be stored to the controller as an integral part of the system assembly and service process ([7], [8], [9]).

A standard mobile PLC has been used as a hardware. Because the controller application has been developed by using IEC 61131-3 programming languages [10], it may be easily deployed into any mobile PLC supporting IEC 61131-3 programming and a CANopen interface. Such enables easy hardware adaptation to various valve configurations in a cost-efficient way. It also minimizes availability and obsolescence risks of the hardware.

However, the controller deployment is far away from complete. The future development may include some setpoint conditioning features increasing the flexibility further. Also, support for a differential hydraulic connection and integrated axis controller are attractive future enhancements. Regarding the parameter objects, some improvement ideas for the future CiA 408 version have been found. ◀



Learn more



The adaptive machine

Your competitive advantage

Today's challenges

Mass customization

Product proliferation

Short product lifecycles

Adaptive machine solutions

Machines that make to order

Instant changeovers on-the-fly

Easy reconfiguration via digital twins

To win in a world of mass customization, e-commerce, direct-to-consumer and omnichannel, it takes machinery that's built to adapt. The first machinery concept that adapts to the products being produced and packaged! B&R enables adaptive manufacturing through intelligent mechatronic product transport integrated with robotics, machine vision and digital twins.

br-automation.com/adaptive

Author



Dr. Heikki Saha
TK Engineering
heikki.saha@tke.fi
www.tke.fi

UDSonCAN – a diagnostic protocol for various CAN applications

The Unified Diagnostic Services (UDS) are standardized in the ISO 14229 series. Part 3 specifies the CAN-mappable ISO-TP transport protocol standardized in ISO 15765-2. This approach has been adapted for J1939 and CANopen, too.

Sophisticated diagnostics is an important feature for any kind of vehicles. There is a growing need to incorporate diagnostic measures into CAN-connectable devices. Some CAN-based higher-layer protocols such as SAE J1939 specify a set of specific diagnostic messages, which cover different use cases, e.g. reporting of active Diagnostic Trouble Codes (DTCs) or control of communication behavior (such as for example ‘stop broadcast messages’). In CANopen, Emergency (EMCY) messages can be used to publish diagnostic information and devices may keep error history objects, which can be read later. Finally, OBD-II is well known in the automotive industry for diagnostics purposes.

And, there are the Unified Diagnostic Services (UDS) defined in the ISO 14229 standard series. In the meantime, the UDS approach is used in different industries. Albeit, UDS can be used on different communication protocols such as LIN and Ethernet, this article focuses on UDSonCAN as specified in ISO 14229-3:2022. Classical CAN data frames have a limited data field of 8 byte and the CAN FD data frame is limited to 64 byte. But some UDS services require more payload. In this case, a transport layer protocol is needed, which segments the diagnostic message on the transmitter side and re-assembles the segments on the receiver side.

The ISO-TP transport layer protocol

ISO has standardized a CAN-based transport protocol in ISO 15765-2 (also known as ISO-TP), which is currently under revision. It supports classical CAN and CAN FD, accommodating payloads of up to 4 GiB. However, for the sake of simplicity, the article will focus on the explanation of the traditional ISO-TP protocol, which allows for payloads of up to 4095 byte on classical CAN.

There are four segment types specified:

- ◆ Single Frame (SF) to transfer data up to 7 bytes,
- ◆ First Frame (FF) to initiate a multiple-segment transmission,
- ◆ Flow Control (FC) frame to control multiple-segment transmissions,
- ◆ and Consecutive Frames (CF) that contain the payload of multiple-segment transmissions.

ISO-TP specifies four addressing formats

Normal Addressing arbitrary with 11-bit or 29-bit CAN-IDs can be used to designate the producer and receiver of the messages. Normal Fixed Addressing supports only 29-bit CAN-IDs, where some bits (28 to 26 and 23 to 16) are ▶

Time Stamp	CAN-ID	Source	Destination	Protocol	Segment Type	Payload	CAN data
48777.461000	0x18da97f9	- Tester	ECU	length = 4	Single Frame	31 01 ff 55	04 31 01 ff 55 55 55 55
48780.068000	0x18daf997	- ECU	Tester	length = 3	Single Frame	7f 31 78	03 7f 31 78 55 55 55 55
48780.948000	0x18da97f9	- Tester	ECU	length = 9	First Frame	34 00 24 80 00 00	10 09 34 00 24 80 00 00
48782.947000	0x18daf997	- ECU	Tester	block size = 16	Flow Control	-	30 10 00 55 55 55 55 55
48783.828000	0x18da97f9	- Tester	ECU	-	Consecutive Frame	00 52 c0 55 55 55 55	21 00 52 c0 55 55 55 55
48787.635000	0x18da97f9	- Tester	ECU	length = 4	Single Frame	31 01 ff 55	04 31 01 ff 55 55 55 55
48791.508000	0x18da97f9	- Tester	ECU	length = 1022	First Frame	36 01 7f 45 4c 46	13 fe 36 01 7f 45 4c 46
48792.436000	0x18daf997	- ECU	Tester	block size = 32	Flow Control	-	30 20 00 55 55 55 55 55
48793.156000	0x18da97f9	- Tester	ECU	-	Consecutive Frame	01 02 03 04 05 06 07	21 01 02 03 04 05 06 07
48793.828000	0x18da97f9	- Tester	ECU	-	Consecutive Frame	08 09 0a 0b 0c 0d 0e	22 08 09 0a 0b 0c 0d 0e
48794.516000	0x18da97f9	- Tester	ECU	-	Consecutive Frame	0f 10 11 12 13 14 15	23 0f 10 11 12 13 14 15
49089.845000	0x18da97f9	- Tester	ECU	-	Consecutive Frame	16 17 18 19 1a 1b 1c	24 16 17 18 19 1a 1b 1c

Figure 1: ISO-TP interpretation showing the four segment types using the DeviceExplorer tool (Source: Emotas)

Time	CAN-ID	Type	Len	0	1	2	3	4	5	6	7
38.758568	0x7e0		8	0x03	0x22	0xf1	0x90	0xcc	0xcc	0xcc	0xcc

Time	CAN-ID	Type	Len	0	1	2	3	4	5	6	7	Notes
525.722642	0x7e0		8	0x02	0x27	0x01	0xcc	0xcc	0xcc	0xcc	0xcc	Single Frame
525.723049	0x7e8		8	0x10	0x0b	0x67	0x01	0x02	0x03	0x04	0x05	First Frame
525.723097	0x7e0		8	0x30	0x20	0x00	0xcc	0xcc	0xcc	0xcc	0xcc	Flow Control
525.723133	0x7e8		8	0x21	0x06	0x07	0x08	0x09	0x0a	0xcc	0xcc	Consecutive Frame

Figure 2: UDS data embedded in ISO-TP (Source: Emotas)

pre-defined and both the source address and target address are coded into the CAN-ID. Extended Addressing uses the first data byte of the CAN data frame to address devices, so that the possible payload is reduced but less CAN-IDs are required. Finally, Mixed Addressing is an additional address scheme for remote diagnostics.

ISO-TP is used by UDS to transfer the UDS data, but the usage of the different ISO-TP addressing schemes and the CAN-IDs is usually defined by the application layer protocol of the network. Using J1939 with UDS requires Normal Fixed Addressing with 29-bit CAN-IDs mapped to specific J1939 Parameter Groups (PG): DIAG1, DIAG2, DIAG3, and DIAG4. They are specified in detail in ISO 15765-2, the SAE J1939DA (digital annex) defines just the Parameter Group Numbers (PGN) and references to the ISO document.

UDS solutions for different platforms

Emotas offers UDS server and UDS client solutions. These software packages are available as extensions for the company's CANopen, J1939, and RawCAN protocol stacks. In other words, the company does not offer a separate UDS server stack. The UDS server is integrated into the company's protocol stacks. The same is possible with UDS client (tester) functionalities. ISO-TP with all mentioned addressing methods is also included. Both the UDS server and the UDS client extension support a set of UDS services. The API (application programming interface) covers both service-specific functions and higher functionalities that include multiple UDS services into a comprehensive procedure (e.g. to do a download of a complete firmware via UDS).

In addition to the stack extensions and UDS boot loaders, the provider offers a couple of UDS extensions for its tool chain that is available for Windows and Linux. Plug-ins for both the CANinterpreter and the CANopen DeviceExplorer tools allow to interpret CAN data frames according to the ISO-TP and UDS specification. Additionally, a 'UDS transmitter' provides functions to send single UDS commands or a sequence of them. The tools' scripting engine provides also a set of UDS-specific commands to implement customer-specific UDS sequences for testing purposes.



WE ARE GROWING!

Join a leading CAN development company with swedish R&D, where tech meets innovativeness.

We are seeking talented individuals in all areas to join our expanding team. Enjoy global collaborations in a flexible, friendly and generous work environment.

Embark on this exciting journey with us:

[CAREER.KVASER.COM](https://www.career.kvaser.com)



Time Stamp	CAN-ID	Source	Protocol	-	Payload	Interpretation
49401.245000	0x7e0	Tool	Request	DiagnosticSessionControl	10 02	programmingSession
49402.819000	0x7e8	Bootloader	Response	DiagnosticSessionControl	50 02 00 c8 01 f4	programmingSession 200 ms, 5 s

Figure 3: Request and response of the DiagnosticSessionControl service (Source: Emotas)

Time Stamp	CAN-ID	Source	Protocol	-	Payload	Interpretation
50503.084000	0x18da97f9	Tester	Request	ReadDataByIdentifier	22 f1 90	0xf190: VIN
50503.096000	0x18daf997	ECU_Device	Response	ReadDataByIdentifier	62 f1 90 65 6d 6f 74 61 73 20 42 6f 6f .. (+7)	

Figure 4: Request and response of the ReadDataByIdentifier service (Source: Emotas)

Time Stamp	CAN-ID	Source	Protocol	-	Payload	Interpretation
49689.810000	0x7e0	Tool	Request	SecurityAccess	27 01	requestSeed
49689.812000	0x7e8	Bootloader	Response	SecurityAccess	67 01 00 c8 01 f4	requestSeed
49689.814000	0x7e0	Tool	Request	SecurityAccess	27 02 af be 23 00	sendKey
49689.816000	0x7e8	Bootloader	Response	SecurityAccess	67 02	sendKey

Figure 5: Request seed and send key using the SecurityAccess service (Source: Emotas)

In the CiA 447 CANopen profile for special-purpose car add-on devices, Normal Addressing with 11-bit CAN-IDs is used. The specified CAN-IDs cannot be used for generic CANopen functions. Other higher-layer protocols or UDS in proprietary networks need to specify the desired and appropriate addressing.

The Unified Diagnostic Services

UDSonCAN provides a set of different services to read or to write data, to modify outputs, to manage access rights, to change communication behavior, and to download data to ECUs (electronic control units) in a CAN network.

Normally, UDS services are initiated as requests from a tester and they are usually responded by the ECU. In some cases, it is possible to suppress positive responses, which do not contain any additional data. Each UDS service has a 1-byte service-ID and the response replies with (service-ID + 40_h) in the first byte of the response. All additional bytes of both request and response depend on the actual service.

A detailed explanation of all UDS services would exceed the scope of the article. Instead, the focus is on a summary of four selected UDS services.

DiagnosticSessionControl (10_h) service

This service is used for transitions between multiple sessions. There are different sessions defined in UDS and a device always starts in the default session, in which only a subset of services is supported. Using the DiagnosticSessionControl service, the tester can command the ECU into other sessions such as Programming Session, Extended Diagnostic Sessions, or various implementation-specific sessions. Each session grants access to a specific set of supported services and actions tailored to its purpose. In the absence of UDS communication with this device, the ECU will automatically revert to the default session after a specific timeout period.

ReadDataByIdentifier (22_h) service

This service can be used to query the value of certain identifiers. One notable example is F190_h for the Vehicle Identification Number (VIN). The identifier is

a 16-bit value and approximately 200 of these identifiers are pre-defined by UDS and thus there is a large free range of manufacturer-specific identifiers. The service also allows reading multiple identifiers by one request.

SecurityAccess (27_h) service

This service provides the functionality to enter dedicated security levels and thus unlock restricted services. The process is based on a challenge-response authentication scheme:

1. The tester requests a seed from the ECU and the ECU generates and sends a seed – a random challenge value back to the tester.
2. The tester calculates a key value based on the provided seed. The algorithm is manufacturer-specific and there can be different algorithms for different security levels. The tester sends the key to the ECU.
3. The ECU verifies the key and if the key matches, the ECU grants access to the requested security level and unlocks the associated services.

TransferData (36_h) service

This service is used to transfer larger chunks of data from or to a device. It is started with the RequestDownload (34_h) service and is finished with the RequestTransferExit (37_h). One TransferData block can contain up to 4093 byte, but the length is defined by the ECU in the response to the RequestDownload request. Multiple TransferData blocks are used to transfer data that exceed the block size of one TransferData block. ◀

Author



Torsten Gedenk
Emotas Embedded Communication
ged@emotas.de
www.emotas.de

CAN XL for real-time control and efficient file transfer



Many engineers are wondering why they should use CAN XL, when 10Base-T1S Ethernet is around the corner. This article provides some detailed background information, which helps to answer this.

CAN XL and Ethernet specify data link layer frames that can be sent over a physical media, so in that sense, there is no difference between them. Everybody dreams of implementing a sole solution to solve all problems: why not just use Ethernet to handle all in-vehicle networks? The reality is that every solution has its pros and cons. The difference between CAN XL, Ethernet or any other layer-2 approach is in the details:

- ◆ How is access to the media secured?
- ◆ How is the start of the frame detected and synchronized to the receiver?
- ◆ How is the bit rate defined?
- ◆ How is it possible to find the start of the user data?
- ◆ How is it possible to find the end of the user data?
- ◆ How is the frame transmission protected from errors?

Classical CAN was designed to provide autonomous communication that could function with limited support from higher-layer protocols. CAN has never claimed to be generic: it was developed to handle real-time information in a simple, safe, and robust way at low cost. To optimize the communication for this real-time task, it was necessary

to accept certain constraints and extensions beyond the generic OSI layer model:

- ◆ Predictable access to the network; arbitration in CAN.
- ◆ Short delays to transmit important data; priority in CAN.
- ◆ Short frames to limit delays; 8-byte data frames in classical CAN.
- ◆ All nodes evaluate the same information at the same time; information is broadcasted in CAN networks.

The last demand (last bullet point) is that all consumers receive the data frame at the same instance in time. The simple solution to this problem is to send and receive all information on one single common media, and in order to deliver that functionality, CAN is limited to simplex communication. With full duplex communication, any node can send at any time because the communication media is always free and available. 100Base-T1 solves this by using point-to-point (P2P) communication with one single media whereby the transmitter can receive a signal by first subtracting the sent energy. This requires relatively complex filtering in the transceiver and as such, is overly complicated when adding just one more unit onto this common

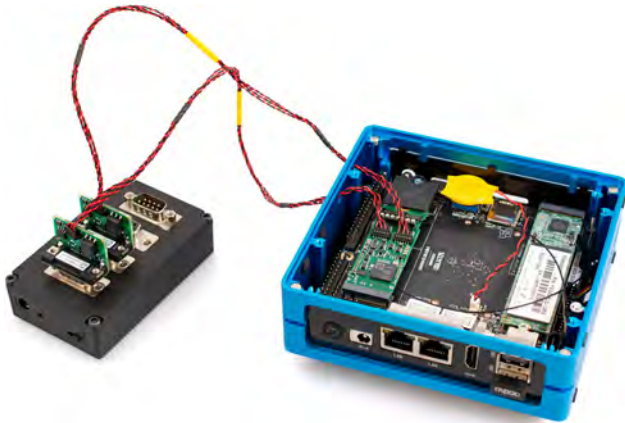

Figure 1: Linux computer with Kvaser's M.2 interface and the two CAN interfaces connected to a short CAN network at the left (Source: Kvaser)

media. There is always a delay in the path between the sampling of the information and the use of the information by the consumer. If this delay has a secured limit, it is possible to use P2P and switches, as in Ethernet today, which spread the data to all consumers. Such solutions are more complex, and the switches add costs. CAN provides a common database with low timing jitter for all installed devices intrinsically.

The least but not last demand in the bullet list, to get frames with limited extensions in time, can be solved in two ways: have frames with few bits and keep the bit-length short (high bit rate). The most common solution to this in the computer world is to increase the clock-rate (bit rate). The cable itself can handle 500 Mbit/s, but cable quality, connectors, and drop-lines disrupt continuity and cause ringing, which limits the usable bit rate. Added to this, CAN XL uses arbitration for bus access, which demands a lower bit rate during the first phase of the package transfer. At the outset, 10Base2 Ethernet was also based on a multidrop network, but to reduce cable complexity, all solutions with more than 10 Mbit/s use P2P in combination with switches and bridges. To lower cable complexity and cost of CAN, it is necessary to use a bit rate as low as possible. CAN XL makes it possible to select a bit rate from 0,125 Mbit/s to 20 Mbit/s, enabling you to achieve the highest possible performance that your cable budget allows. When it comes to overhead, there is no big difference between 10Base-T1S and CAN XL, but the slower arbitration of CAN XL will increase the length in time of the frame transmission. When longer cables are used in CAN XL this same concept requires the use of a slower bit rate during the arbitration phase.

The second demand is how to get fast access to the communication media. The best solution would be to employ a media where anybody can start sending without considering other senders. This problem is partly solved by 100Base-T1, which provides full duplex between the node and the switch, but this just moves the access problem to the switch. If two nodes start to send a frame to one receiving node, the switch must store one of the frames, because it cannot send two frames concurrently. The fundamental Ethernet solution to this problem is CSMA/CD (Carrier Sense Multiple Access/Collision Detection), which means "if the media is free, anybody can start sending and

if a collision is detected, stop sending and wait a random time before returning to CSMA/CD". This works fine for the office LAN and Internet because rare and intermittent delays are no problem as long as they don't significantly lengthen download times. In a real-time system, all delays must be limited to a defined length in time over the lifetime. To solve this problem, it is necessary to define rules to ensure that all units transmit in an order that guarantees that all frames are received within a certain time limit. One such set of rules is defined in the TSN (Time Sensitive Network) standard. CAN XL solves this using CSMA/CR (Collision Resolution), with the only difference being that the collision is not destructive. In this way, the package with the highest priority wins the media and all other senders will receive that frame and recycle the CSMA/CR process.

The first demand is how to resolve a collision without harming the communication package. As described in the second bullet point, this is solved by replacing CSMA/CD as used in Ethernet with CSMA/CR. No transmitter starts sending a frame, if there is already a frame on the communication media (CS). If the media is free however, anybody can start sending a frame. There is therefore the probability that two or more units start sending a data frame at the very same time.

CAN solves collisions one bit at a time so that if a unit is sending a recessive bit "1" and it reads back a dominant bit "0", it will back off and stop sending bits. This is what's known as bit-wise arbitration: several bits into the CAN data frame, just one sender is left and that winning unit completes transmission of the complete CAN data frame. This nice feature does not come for free because the CAN bit requires time for the signal to stabilize before all nodes read back and check the sampled bit-value. The shortest CAN bit is equal to the longest delay, multiplied by two, plus some phase margin for clock variations and noise. At 1 Mbit/s, the time budget in the bit is 1000 ns. To protect the sample point from random phase noise, it is recommended that a 10-% phase margin is used, which reduces the available bit time to 800 ns. A 0,5-% oscillator tolerance in the nodes could cause a phase offset as large as $0,5 \%/\text{bit} \times 10 \text{ bit} \times 2 = 10 \%$, which could further reduce available bit time to \triangleright

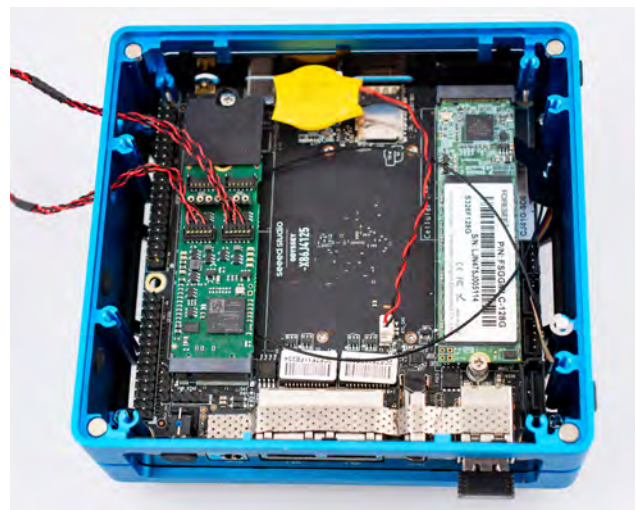

Figure 2: The M.2 interface including the CAN XL IP core to the left; the second M.2 slot to the right holds the SSD (Source: Kvaser)

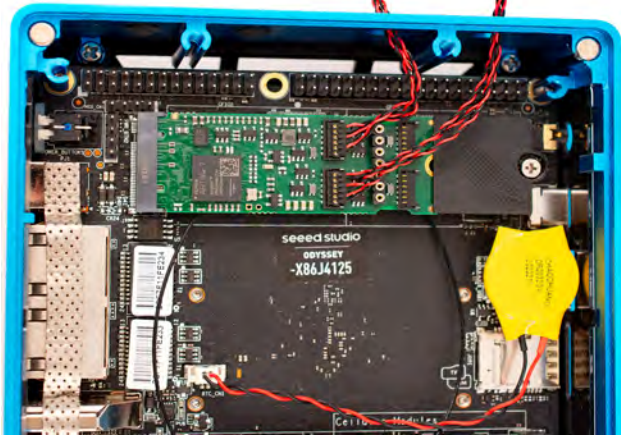

Figure 3: The CAN transceivers are located on a separate module and red/black wires are the connection between the M.2 module and the CAN transceiver (Source: Kvaser)

600 ns. The CAN transceivers typically have a delay below 200 ns, reducing the available bit time to 200 ns. With a cable delay at 5 ns/m, the cable must be limited too; $200 \text{ ns} / (2 \times 5 \text{ ns/m}) = 20 \text{ m}$. Modern transceivers could reduce delay to 50 ns, which combined with good oscillators would reduce the total phase margin to 10 % of the CAN bit length. However, to increase the bit rate, it is necessary to reduce delays more and the only major option is to reduce cable length.

To combine higher bit rate and longer cables in CAN networks, a different approach is needed. As seen from the description above, a low bit rate is only necessary during

arbitration. Once one sender has won, the bit rate is only limited by the CAN-transceiver slew-rate and the cable layout (impedance variations). Cleverly, CAN XL starts out with a lower bit rate that matches the cable length (delays) during the arbitration phase and once there is only one sender, it switches to a higher bit rate. During the CiA-organized plugfest in Detroit we ran CAN XL at 20 Mbit/s over 30 m. It should be possible to achieve speeds of more than 20 Mbit/s with a carefully designed cable layout.

Where Ethernet wins over!

The main reason for using Ethernet is when communicating with a normal computer over LAN and Internet, because it is possible to use usual TCP/IP without any modification. If you only need to transfer information over a serial communication, Ethernet is the obvious choice. Windows, Linux, and many other OS (operating systems) have software support such as TCP/IP and UDP included, providing a fast track for software development.

Real-time video transmission necessitates the use of high bandwidth communication channels (0,1 Gbit/s to 5 Gbit/s). MIPI is used today, which is essentially normal Serdes LVDS (low-voltage differential signaling) and was designed to connect the camera to the computer inside a housing.

Ethernet provides a more robust technology that is designed to survive in a relatively rough environment. If Ethernet is used for cameras and other devices that ▶

**CAN
Controller
IP Core**

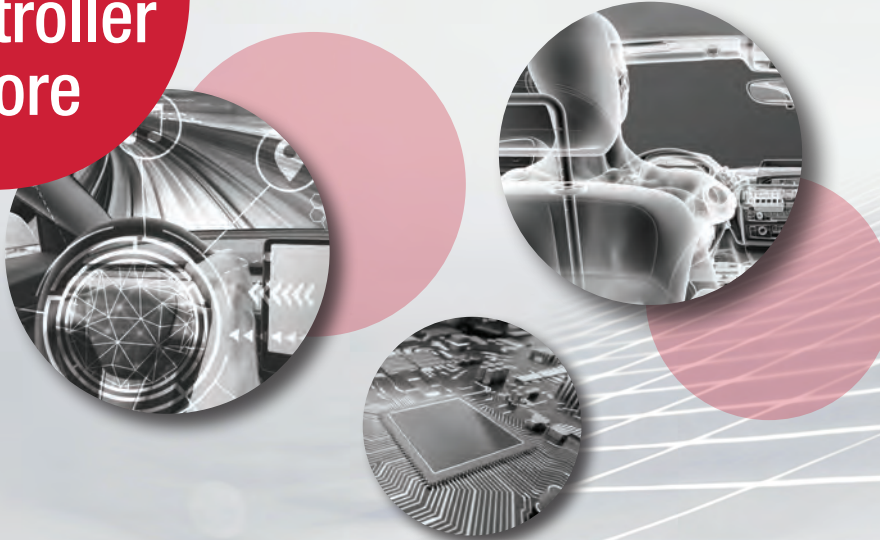

COMPLETE
CAN 2.0, CAN
FD, CAN XL plus
TTCAN
AUTOSAR & SAE
optimization

SECURE
Available
CANsec

SAFE
Designed for FuSa
Certified as
ASIL-D Ready

RELIABLE
Plugfest-verified
& proven in
hundreds
of customer
systems

FLEXIBLE
ASICs or FPGAs;
Works with any
Transceiver

CAST

Learn more at: www.cast-inc.com or email info@cast-inc.com

30 Years
Serving IP Customers

Kvaser and CAN XL

Kvaser has added CAN XL functionality to its existing CAN/CAN-FD IP core. This IP core is mostly used in FPGA-based products, but it is also used for the MCU for at least one major player. It forms the base for Kvaser's CAN XL developments. A challenging aspect of the design is the increased package size, which demands CAN buffers with 8 byte, 64 byte, and up to 2048 byte. The other big concern is how to efficiently handle a burst of short frames with few bytes mixed with long frames with 2048 byte.

The first step was to confirm that the IP still matched the Bosch CAN/CAN FD reference model, after which CAN XL functionality could be added to the existing IP core. Compared to adding CAN FD to classical CAN, it was relatively easy to add CAN XL functionality as it includes just more CRC blocks, bit-timing registers, PWM (pulse-width modulation), and some additional slightly more complex functionality. Despite the absence of a reference model for CAN XL, Kvaser experienced no problems in communicating with all the hardware that showed up at the CiA plugfest in Detroit. The CAN XL development board by C&S does not have fault injection, so it was not possible to test all fault conditions error handling. The error handling is relatively complex and to have everything 100 % correct without a reference model is not to be expected. Without a reference model it will be complicated to secure a compatible CAN XL IP.

need high bandwidth, it is tempting to also use it for low-bandwidth signals that today run over CAN. Even though audio and video are both time critical, they have some major differences with most other real-time signaling:

- ◆ The signaling is asymmetric, with high bandwidth from the camera and almost none to the camera. The same is true for the video display but in the opposite direction.
- ◆ The bandwidth is constant and with a fixed frame rate.

It would be possible to expand the time schedule used for video to also include other real-time signals. The problem is that in a car there is also a huge number of parameters that occur very rarely but still must be treated as real-time data (e.g. headlight switching, turn light). This is the main reason, that there have seen solutions such as TT-CAN and Flexray. Ethernet as such is not intended for real-time communication (even if it is fast) and to provide predictable signaling in Ethernet TSN is placed on top of the Ethernet to provide scheduled traffic with a guaranteed maximum delay for all critical data.

To decrease latency there are Ethernet transceivers designed to support PHY-level Collision Avoidance (PLCA), which is a fixed order transmission with dynamic slot lengths. An overview and some simulations can be found in the paper entitled 'PLCA Clause 148 Overview'. As described in this paper, PLCA is very efficient for frames with more than 60 byte, but the latency for 8 nodes is 4 ms to 8 ms, compared to 0,25 ms for CAN at 1 Mbit/s for any number of nodes for the package with the highest priority. For each package with a lower priority, 0,125 ms should be

added to give us 15 high-priority CAN frames sent within the first 2 ms. This equates to 120 byte sent from 15 nodes, during which time, two 10Base-T1S nodes have transferred 2500 byte. However, it should be remembered that another 6 ms are needed before all eight nodes have had a chance to send information.

The case for CAN/CAN XL

Serial communication in a real-time control system is more complicated than just downloading a file. CAN is optimized for real-time control even with low demand on component tolerance, limited software and use of low-cost cabling. When CAN was invented in 1983, the MCUs (micro-controller units) have had 4-KiB ROMs, 128-byte RAMs, and 1,5-% oscillator tolerance. To run Ethernet, 50-ppm (parts per million) oscillators are needed. TCP/IP software size is about 6 KiB for the micro-IPs and 23 KiB for lightweight-IPs, while at least a 2-KiB RAM allows for small Ethernet frames only. The main justification for using LIN and CAN FD Light is to reduce the hardware cost further by making components without any software. The use of a product without or with limited software also makes it simpler to secure functional safety standards like ISO 26262.

With the CAN XL technology it is possible to optimize the bandwidth and delays to the installed cable layout to within the range of 0,125 Mbit/s to 20 Mbit/s. Thus, CAN XL provides an excellent compromise between small software, flexibility, cost, and performance. ◀



Author

Kent Lennartsson
Kvaser
kent@kvaser.com
www.kvaser.com

Galvanic isolated CAN nodes in small satellites



Outer space applications require radiation-tolerant CAN transceivers and galvanic-isolated CAN interfaces.

(Source: Adobe Stock)

Small satellites are becoming a more dominant area of the space and satellite market place. In 2019, more than 1000 small satellites were launched. Many satellite companies are starting to design and build what are known as “Mega-Constellations”. These are systems of satellites that are intended to have potentially hundreds of satellites flying in Low Earth Orbit (LEO). The mission length for many of these satellites is longer than 5 years, compared to 15+ years for more traditional satellite missions. These satellites will be used mainly for telecommunications, but have other uses such as scientific exploration and earth observation. In 2022, the global small satellite market size was valued at three billion US-\$ and is expected to reach 13,2 billion US-\$ by 2032, according to a research report published by Spherical Insights & Consulting. As of May 4, 2023, the satellite tracking website “Orbiting Now” lists 7702 active satellites in various Earth orbits.

Small satellites represent some important changes from the traditional satellite market. First, as the name implies, small satellites take up substantially less volume and weigh significantly less than traditional satellites. Small satellites are typically defined as having a mass of less than 500 kg. Another key feature of small satellites is reduced cost. In order to build a constellation of 100 or

more satellites, the aggregate cost of each of these must be far lower than traditional satellites. These size and cost constraints make it challenging to build satellite electronics using standard Class V and QML radiation-tolerant products. The challenge is that many of these small satellites have some quality and radiation-tolerance requirements that cannot be met using commercial-off-the-shelf (COTS) components.

The European Space Agency (ESA) has developed the ECSS-E-ST-50-15C specification. It contains requirements regarding CAN hardware, CAN firmware, and CANopen for on-board spacecraft communications and control systems. It extends the specification of the ISO 11898-1 and ISO 11898-2 standards. Radiation-tolerant CAN transceivers compliant with ISO 11898-2 consist of driver and receiver circuitries. The transmitter circuitry takes a digital serial data stream from the CAN protocol controller and drives the CAN_H and CAN_L bus lines with the appropriate differential signal levels. Galvanic isolation can be used to provide protection against transients induced on the bus, including those caused by Single Event Effects (SEE) from heavy ions in the space environment.

Intersil (now part of Renesas) has developed the ISL71026M radiation-tolerant CAN transceiver and the ISL71710M active digital isolator. Both components come in plastic housings. This saves space on the printed circuit board, which is important for small satellites. Both mentioned components measure 20 mm² each.

The CAN network needs to be terminated on both ends of the bus lines by means of 120-Ω resistors. The recessive

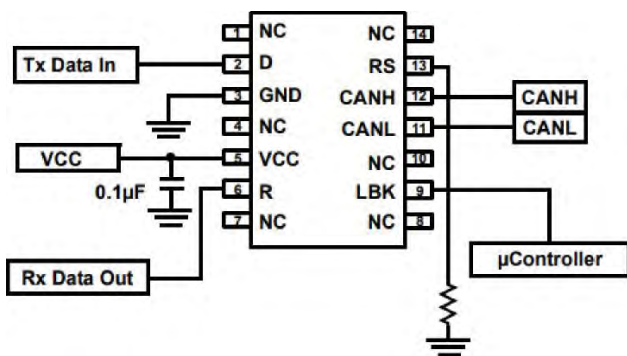

Figure 1: Pin assignments for the ISL71026M transceiver (Source: Renesas)

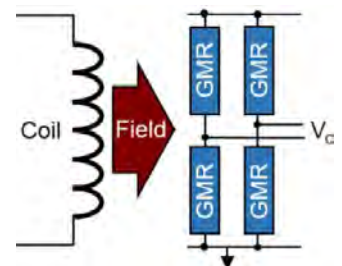

Figure 2: ISL71710M circuitry using GMR technology (Source: Renesas)

Applications

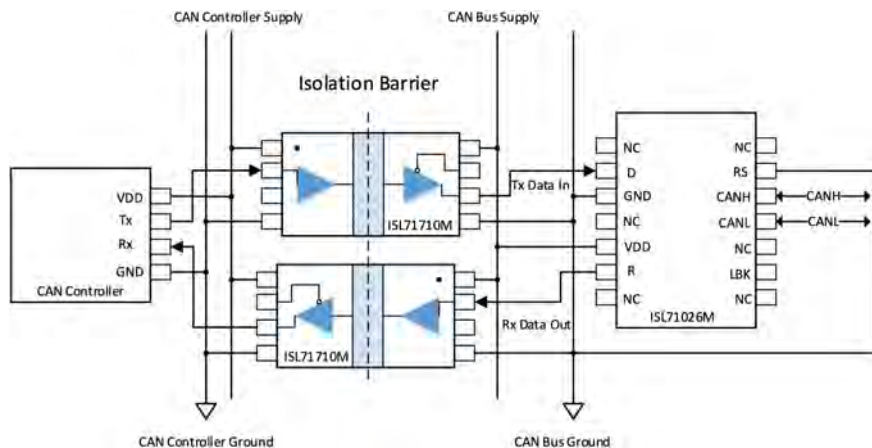

Figure 3: Isolated CAN node using ISL71710M and ISL71026M (Source: Renesas)

state voltage is approximately 2,3 V on both bus lines. In the dominant state, CAN_H goes up to approximately 3 V and CAN_L goes down to approximately 1 V.

The CAN network can be used effectively in a distributed computing application. For example, a satellite payload may have multiple environmental or positioning sensors spread out across the payload board. Using an isolated CAN network to communicate between different CAN nodes is an efficient way to transmit sensor and position data. The isolation ensures protection for the CAN controller.

Renesas has a portfolio of products that are specifically designed for small satellite applications. These products have a higher level of qualification than COTS components that is similar to automotive grade semiconductor products. In addition, the products in this portfolio have been screened for radiation tolerance.

The ISL71026M is a CAN transceiver that follows the radiation-tolerant plastic flow outlined above. It is a 3,3-V CAN transceiver that can operate up to the maximum CAN bit rate of 1 Mbit/s.

The ISL71710M is an active input digital isolator that follows the radiation-tolerant plastic flow. It uses an isolation technology that works on the principles of Giant Magneto Resistive (GMR) effects. This technology allows efficient digital isolation with low-quiescent current, no EMI (electromagnetic intermission) concerns, and no issues with optics greying over time. The GMR technology works using a coil on the input side. This coil is energized and driven by the input buffer, and the polarity depends on the output state of the buffer. This energized coil produces an electric field across the isolation barrier and induces a change in resistance of the GMR elements. As the resistance changes, it causes the output to change the state accordingly.

It is important to note that the ISL71710M digital isolator must be placed in between the CAN protocol controller and the CAN transceiver. This allows the sensitive micro-controller supply to be isolated from the CAN transceiver supply. It is also important to note that while the ISL71710M provides inherently isolation for the data signals, the power supplies for the ISL71710M and the CAN controller must also be isolated. If these are simply tied together, the benefits of using a digital isolator cannot be realized.

Since the ISL71710M and the ISL71026M are packaged in plastic enclosures, much of the cost of typical space products has been removed. In addition, Class V flow for space semiconductors has many production-level tests that add significantly to the cost. These tests include visual inspection, radiography, 100-% burn-in, and 100-% temperature cycling. Removing these in-line production tests allows Renesas to pass the cost savings of those products on to customers. Renesas provides evaluation boards and detailed user guides for customer testing and evaluation.

hz (based on a Renesas whitepaper)



Figure 4: ISL71710M (left) and ISL71026M (right) evaluation boards (Source: Renesas)

CAN data acquisition: Challenges and solutions

CSS Electronics specializes in CAN data acquisition solutions. The company offers CAN data loggers, sensor-to-CAN modules, and free open-source software/API tools - as well as customer support and know-how.

CSS Electronics frequently offers new guides and videos on CAN topics. Recently, the company added a [45-minutes webinar](#) focused on how to log CAN data. Below are seven use case examples on how CAN data logging can be done using the company's CANedge data loggers:

- ◆ **Blackbox for diagnostics and warranty disputes:** Many OEMs install the CANedge data logger as a blackbox in their vehicles and machines. With cyclic logging and filters, pre-scalers, and compression, this allows them to have a rolling window of e.g. the last 12 months of CAN data available on an SD card. This can be valuable if an intermittent issue arises or a customer warranty dispute occurs. The data can also be encrypted for confidentiality and integrity.
- ◆ **Mixed vehicle fleet data logging:** The loggers can also be used in mixed fleets (e.g. trucks, buses, tractors, or cars) and after-market deployments. For example, the raw J1939 data can be recorded and decoded using the available [J1939 DBC](#) (data base CAN) across different vehicle brands, models, and years. Similarly, in car fleets, the [OBD2 DBC](#) can be used to extract various signals.
- ◆ **Warehouse telematics and predictive maintenance:** The CANedge2 is suited for deployment in warehouses, e.g. to collect data from forklifts and AGVs (automated guided vehicles). Here, the devices log data to the SD and auto-offload the data when in range of a Wifi router. Data can be sent to the user's own cloud or self-hosted server (e.g. on a local network). A popular use case is predictive maintenance, where log files are auto-processed upon upload via the Python API or Matlab. In simple use cases, signals are evaluated against thresholds (e.g. for temperatures) and trigger SMS/email alerts to avoid asset damage or downtime. More advanced use cases involve models such as 'digital twins' and machine-learning-based estimates of remaining-useful-life. See for example a [recent case study](#) on how the CANedge2 is deployed across 250+ AGVs to enable warehouse predictive maintenance.
- ◆ **Marine telematics (NMEA 2000):** Collecting data from maritime vessels can be key in reducing emissions, optimizing energy consumption, diagnosing issues, and more. Here, the logger can be used to record the raw J1939/NMEA 2000 data to an SD card for later analysis. Further, with the CANedge2, data can be automatically offloaded e.g. via an onboard Wifi network to a local server, or via a 3G/4G router to a remote cloud when the vessel is within coverage. The NMEA 2000 data can be decoded using the [NMEA 2000 DBC](#).



Figure 1: For fleet management, the raw J1939 data can be recorded and decoded using the available J1939 DBC file (Source: CSS Electronics)

- ◆ **CAN dashboard visualization:** To visualize data from vehicles or machines in dashboards, log files from the CANedge can be integrated with Grafana, enabling users to set up free customized dashboards. This can be helpful in diagnosing issues, benchmarking performance, or offering services towards end customers. The data can also be auto-pushed to a server and visualized in near real-time.
- ◆ **Reverse engineering:** In many applications, the CAN data is proprietary and only known to the manufacturer. The CLX000 (e.g. CL2000) serves as a CAN logger and USB interface in one device. This makes it suitable for ad hoc analysis, such as CAN reverse engineering. With the SavvyCANGUI tool, it is possible to send, receive, and replay data in real-time, DBC-interpret it, and create real-time signal plots. The tool also offers the "sniffer view" feature for reverse-engineering discrete signals such as door locks, seat belts, buttons (etc.) or continuous signals such as SOC (state of charge), RPM, etc.
- ◆ **Replacing CAN/LIN hardware:** The CANedge is designed to offer professional-grade specifications at a lower cost and smaller form factor vs. comparable devices. This makes it an alternative in particular for use in OEM late-stage fleet testing and diagnostics. The logger uses the standardized MDF (*.MF4) file format and comes with converters for turning files into Vector ASC, Peak TRC, Excel CSV, etc. The MF4 format is also natively supported in Matlab's Vehicle Network Toolbox. As a result, the device can be deployed as a supplement to existing hardware solutions without having to learn new software tools.

Sensor-to-CAN modules

CANmod.gps module produces GNSS (global navigation satellite system) position and 3D inertial data (via a gyroscope and accelerometer) and outputs it via configurable CAN frames. It supports untethered dead reckoning (UDR) meaning that even if the GNSS signal is lost, the module can deliver continuous positioning through IMU-based estimates (no external inputs required). In addition to position, it produces signals such as speed, odometer, heading, pitch, roll, acceleration rates, and more.

CANmod.temp module produces temperature data from four thermocouple sensors and outputs it via CAN. The module supports all thermocouple types (B, E, J, K, N, R, S, T) and can be daisy-chained for 8, 12, 16, and more channels.

CANmod.input module produces analog, digital and pulse measurements from eight input channels and outputs the data via CAN. The compact device offers high-accuracy and high-frequency sampling as well as configurable input ranges and digital thresholds.

The devices can be integrated with any CAN network due to the customizable bit rate and CAN-IDs. Users can install them standalone to inject sensor data into e.g. a vehicle or machine CAN network. The devices can also be used as extensions for CAN data acquisition hardware e.g. by connecting CANmod modules to the CANedge's second port. This way, the CANedge can record e.g. vehicle data via channel 1 and e.g. time-synced GNSS/IMU and temperature data via channel 2.

of

Record CAN/LIN and GPS/IMU data

CANedge is a two-channel CAN/LIN data logger with an SD card dedicated for automotive, maritime, or industrial applications. Recently, CSS Electronics has released the versions of the [CANedge1/CANedge2](#) that include a GPS/IMU (global positioning system/inertial measurement unit) module. This is effectively similar to combining the CANedge with another product by CSS Electronics, the CANmod.gps (a GPS-to-CAN module), but with lower costs and in a more compact way. The device comes with free open-source software/API tools and offers Wifi connectivity for uploading log files to remote servers.

Added features are more than 40 GNSS/IMU signals including position, speed, trip distance, XYZ acceleration, roll, pitch, yaw, and more. The device also supports 'sensor fusion', combining the GPS data and 3D IMU data. This enables three-times higher positioning accuracy and enables consistent data even in GNSS-hostile areas (e.g. parking lots, tunnels, mines, etc.).

All GNSS/IMU signals can be output at up to 5 Hz. Users can customize which messages to record and at what frequency. The device comes with a CAN database (DBC file) to enable easy decoding of the internally

generated data. As a bonus, the CANedge can use the internally generated GNSS/IMU signals to control whether to start/stop logging/transmission of data on both CAN channels. It can also use the high-precision, GPS-based timestamp to synchronize the real-time clock. This enables precise synchronization of time across all devices. The manufacturer also updated the enclosure of the device, adding mounting flanges and making it more compact (8 cm x 5 cm x 2 cm).

Example use cases

Combining CAN/LIN data and GNSS/IMU data is useful in many practical use cases. For example, one user deploys the CANedge2 incl. GNSS/IMU to log data from two CAN networks of prototype luxury cars during field tests, providing time-synchronized details on the vehicle dynamics in parallel with the CAN data. The combined data is visualized in open-source Grafana dashboards, enabling quick sharing of information across team members for optimization and diagnostics.



Figure 2: CANedge2 including a GPS/IMU module (Source: CSS Electronics)

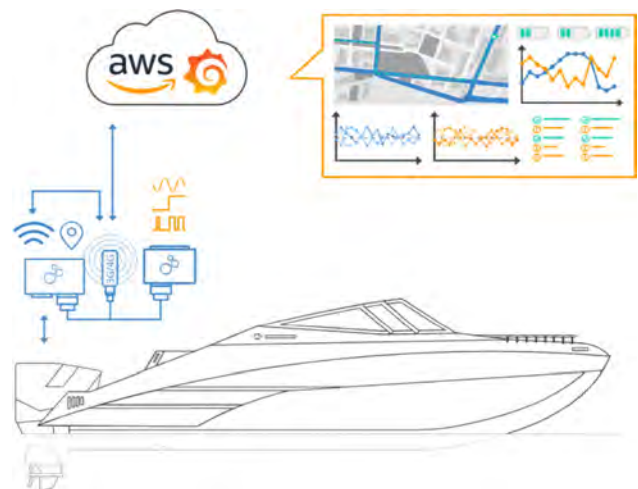

Figure 3: NMEA 2000 data along with GNSS/IMU data can be offloaded via a 3G/4G WiFi router to the user's own AWS cloud server (Source: CSS Electronics)

Another use case involves measuring state of charge, speed, positioning, and more across a fleet of more than 30 vehicles, consisting of a mix of electric cars (e.g. VW ID4) and non-electric cars. This use case focuses on evaluating the potential electrification of a vehicle fleet, which requires data collection for more than a year. Due to GDPR and privacy concerns, the data must be collected offline in encrypted form, for which the CANedge1 incl. GNSS/IMU is suitable. The use case also leverages the support for geofences to determine the “time spent” within electric vehicle charging zones.

In the maritime industry, the new solution enables easy recording of NMEA 2000 data along with GNSS/IMU data. Some users further combine the recent CANedge with e.g. the CANmod.input to add analog,

digital, or pulse signals from various sensors into the same log file. Data can be offloaded via e.g. a 3G/4G Wifi router to the user’s own AWS cloud server. ◀



Author

Martin Falch
 CSS Electronics
contact@csselectronics.com
www.csselectronics.com

Available software and API tools

The following overview shows some of the software/API tools available for products from CSS Electronics. The tools are free and open source. Most of them can be tried out without a device by using the manufacturer’s CAN sample data, DBC files, and playground links.

For device and file management

Config editor enables users to configure the CANedge/CANmod devices via a simple browser-based GUI (graphical user interface).

CANcloud lets users login to their own S3 server and manage connected CANedge2 devices and uploaded log files. Users can track devices in the field via the status dashboard and perform over-the-air configuration and firmware changes.

For data processing and visualization

MF4 converters let users convert log files to other formats enabling easy loading in e.g. Peak’s PCAN-Explorer or Vector CANalyzer.

Asammdf GUI is a general-purpose analysis tool for viewing the log files in raw form (showing the CAN frames), as well as for DBC decoding the data to physical values. The CANedge MF4 log files can be natively loaded in this Windows/Linux GUI tool. The tool also enables visualization of data via plots, including time synced GPS position plots. Further, the tool can export raw or decoded data into various formats such as Excel *.csv or Matlab *.mat.

Grafana lets users set up custom browser dashboards for visualizing data from the CANedge units. This is suitable e.g. for quick analyses, diagnostics, sharing insights, offering services towards end customers, and more. The setup takes less than 15 minutes and can be tested out with company’s sample data.

Python API allows to list, load, and DBC-decode log files from the CANedge - from local disk or directly from the S3 server. The API exposes data in the popular ‘pandas dataframe’ format. API example scripts to get started are available. The API is convenient for

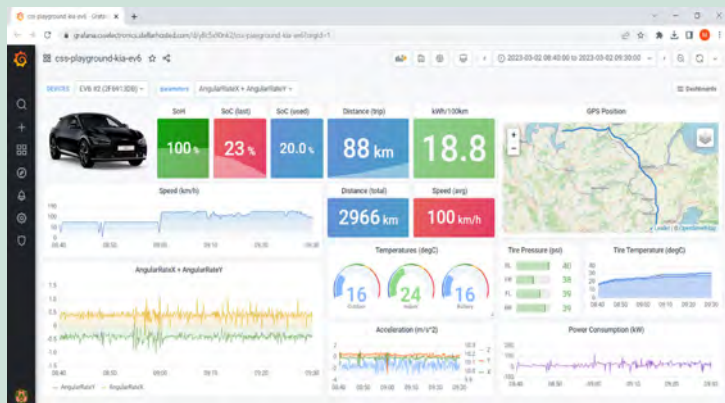

Figure: Grafana tool enables to set up custom browser dashboards for visualizing data from the CANedge units (Source: CSS Electronics)

processing large amounts of data, extracting statistical insights or automating processing (e.g. for setting up alerts or predictive maintenance).

Matlab (API) is familiar for many engineers within the automotive industry. Here, a toolbox called the ‘Vehicle Network Toolbox’ can be used to natively load MF4 log files from the CANedge for further processing. CSS Electronics also provides plug-and-play Python scripts for converting the CANedge log files to *.mat files.

For USB streaming

SavvyCAN: The CLX000 CAN loggers with a USB interface let the user send, receive, and replay CAN data in real-time via USB. The device integrates with the open-source SavvyCAN tool to view raw CAN data in real-time, as well as perform live DBC decoding and signal plots. Sensor data from the CANmod can also be streamed with SavvyCAN.

of

Functional safety in road vehicles

Last decades have proved that safety is crucial in automotive applications. Digital Core Design (DCD) has added the FMEDA (Failure Modes Effects and Diagnostic Analysis) and safety mechanisms to its DCAN (FD) IP core for standalone CAN (FD) controllers.



(Source: Adobe Stock)

Complexity of modern cars is growing rapidly without a doubt. A lot has happened since Ford T and the times when car was just a “fully mechanical” experience. Last few decades prove that safety is crucial. There’s no wonder then, that the safety ecosystem based on proprietary certification is a must. But even the best engineer is not capable of taking care of every single design detail. Everyone makes mistakes. That’s why the automotive industry has adopted stringent processes throughout the supply chain. The final product is modularized, but every submodule, consisting of multiple submodules must be properly documented as well. Why? Because every lifecycle detail must be traceable. The most common automotive standard is the ISO 26262 (see Figure 1) that indicates the whole safety development lifecycle, from the item definition up to the decommissioning.

Evaluation of functional safety

On the other side, is the new design and verification flow really not excessive? Let us consider a simple case – a Tesla car accident. Tesla is a manufacturer that can be described easily – from zero to... hero. Built from the scratch, with keen-on learning engineers, ready to find solutions to encountered problems. Tesla has focused on autonomous cars. But their cars still had some crashes, where the car did work as expected, but still an accident occurred. Why? Due to the wrong design assumptions. The engineer cannot rely on the design itself, but the design must consider the working environment context and consider random faults. To gather an objective evaluation of the functional safety of a product, the Automotive Safety Integrity Level (ASIL) has been introduced. In one sentence – it shows if the design

provides a reasonably low level of failures in time (FIT). This one depends on systematic failures and random hardware failures. The systematic failures can be omitted by a change in design, proper design procedures, and testing. Random hardware failures cannot be omitted, but the risk caused by a hazard can be mitigated.

Safety design flow

DCD has introduced the safety design flow. As an IP (intellectual property) core provider, the company does not consider the whole design, but only the IP design, testing, and safety analysis. The DCAN IP core for Classical CAN and CAN FD implementations is developed as an ISO 26262 Safety Element out of Context (SEooC). The SEooC (the soft IP SEooC in the case of DCAN) is an element developed and analyzed in an assumed context of use, ▶

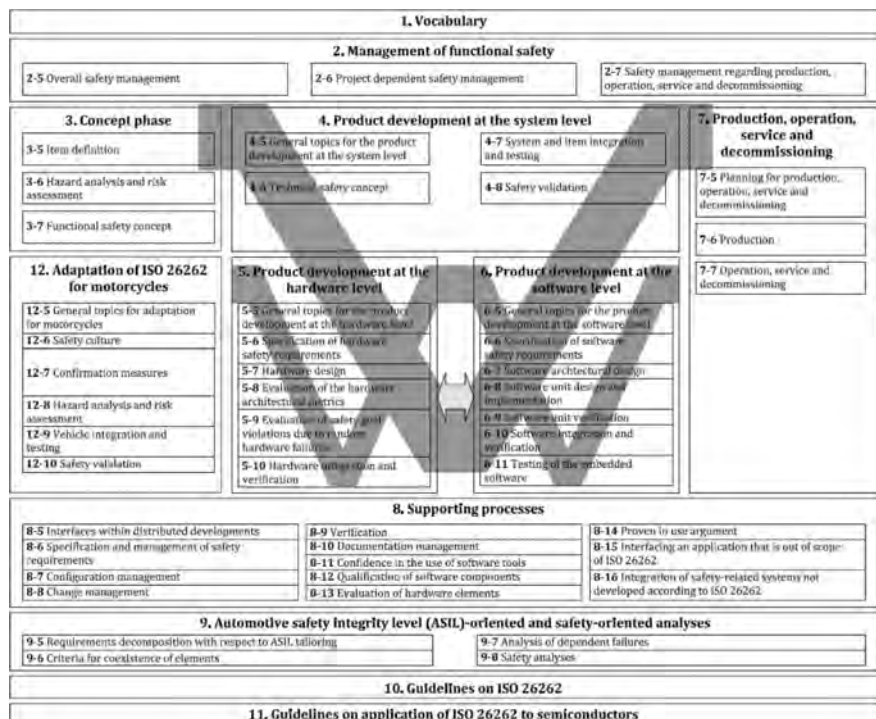

Figure 1: ISO 26262 standards overview (Source: ISO)



Figure 2: The autonomous car design must consider the working environment context and random faults (Source: Adobe Stock)

e.g. target FPGA (field-programmable gate array) board, memory used, etc. The SEooC is delivered with complete ISO 26262 required documentation. Why? To help the system integrator, who must reevaluate the safety analysis based on the target system and the safety analysis of other system elements. The SEooC provides deep

knowledge about the DCAN IP, its failure modes, safety mechanisms that enable to reach the required ASIL level, complete Failure Modes Effects and Detection Analysis (FMEDA) with step-by-step instruction to help to integrate the IP into the customer's system and to conduct the system-level safety analysis. ▶

Call for Papers

The 18th international CAN Conference (iCC) aims to foster collaboration, knowledge exchange, and networking among professionals at the forefront of CAN technology. Join us as expert and submit an abstract showcasing your latest developments, whether they are based on classical CAN, CAN FD, or the emerging CAN XL.

- ▶ CAN implementations
- ▶ CAN device design
- ▶ CAN system design
- ▶ CAN diagnostics
- ▶ CAN higher-layer protocols
- ▶ CAN-related research studies
- ▶ CAN applications in vehicles
- ▶ CAN applications in industry
- ▶ CAN in general-purpose applications
- ▶ Other CAN-related topics



Baden-Baden (DE),
May 14 and 15, 2024

Important date:

- ▶ Abstract Submission Deadline: **September 15, 2023**

Please consider that the iCC Program Committee, chaired by the CiA Managing Director Holger Zeltwanger, considers technical-oriented papers only.

For submission guidelines, sponsorship opportunities, tabletop exhibition details, and further information, please contact CiA office: conferences@can-cia.org

Figure 3: A well-tailored design process with traceable steps and work products brings benefits for the IP provider and the integrator (Source: Adobe Stock)



Safety analysis

Let's now focus on the safety analysis. The main work product is the Failure Modes Effects and Diagnostic (FMEDA) analysis (see below). As the input product to the FMEDA analysis, we need to do a Hazard Analysis and Risk Assessment (HARA). We need to define the Safety Goal(s) of our design and then ask: what can go wrong? We need to detect most functional failure modes, that can lead to a Safety Goal violation. To do so, one should estimate these three factors:

- ◆ Exposure – how likely is the case to happen? How possible is the system to fail?
- ◆ Controllability – what is our ability to control the failure? Is the driver able to handle it?
- ◆ Severity – how harmful can be the occurrence of the hazard? What harm can be caused to the driver?

Knowing what can endanger the Safety Goal, we need to formulate the functional safety requirements to avoid any unreasonable risk for each of the hazardous events. Based on functional safety requirements we need to formulate then, the technical safety requirements, that indicate the safety mechanisms needed for detection of the failure modes.

FMEDA analysis

The FMEDA analysis gathers all the information together. FMEDA is done in a form of a table. There is a plenty of dedicated software solutions that should help in the analysis. But all of them have one common disadvantage – the price, which is (not only) relatively too high.

The use of the forementioned software is not the only way as a simple Excel sheet is good enough for the analysis. Each failure mode in company's FMEDA must have a unique ID assigned to it and a description of the possible effect on the analyzed item. In next columns we need to estimate the distribution of permanent and transient failures to calculate their failure rates measured in FIT. This is the failure rate for the particular failure mode in the absence of any safety mechanisms. Then we need to assign whether the failure leads to a single point fault or to multiple point faults. After that we think of the safety mechanisms that can detect the fault and estimate their diagnostic coverage.

The failure rate (λ , see Formula 1) of a safety-related hardware element (i.e. SEooC) consists of safe faults failure rate, single-point faults failure rate, multi-point faults failure rate, and residual faults failure rate.

The ASIL level is determined by the Single Point Fault metric (SPFM) and Latent Fault metric (LFM).

$$\lambda = \lambda_S + \lambda_{SPF} + \lambda_{MPPF} + \lambda_{RF}$$

Formula 1: Failure rate of a safety-related hardware element

$$SPFM = 1 - \frac{\lambda_{SPF} + \lambda_{RF}}{\lambda} \quad LFM = 1 - \frac{\lambda_{MPPF,L}}{\lambda - \lambda_{SPF} - \lambda_{RF}}$$

Formula 2: Single Point Fault metric (SPFM)

Formula 3: Latent Fault metric (LFM)

Table 1: Required metric values to achieve the proper ASIL level (Source: DCD)

	ASIL B	ASIL C	ASIL D
SPFM	≥ 90 %	≥ 97 %	≥ 99 %
LFM	≥ 60 %	≥ 80 %	≥ 90 %

At this moment DCD cannot share more information about the details of the analysis and the safety mechanisms added to DCAN SEooC and metrics calculation. This is company's know-how combined with the ISO 26262 knowledge. Contact DCD's team, who can help you to find the most appropriate solution related to safety analysis.

And, last but not least, here are some tips why it's worth to integrate a SEooC in your design instead of to conduct the safety analysis on your own:

- ◆ Easy integration
- ◆ Comprehensive IP knowledge by the DCD team
- ◆ Support (really helpful in possible safety anomaly resolution process)
- ◆ Time to market
- ◆ Costs

Conclusion

A well-tailored design process with traceable steps and work products is obligatory today. But despite the necessity, it brings also benefits both for the IP provider and integrator. The formalized design procedures at every design lifecycle step, traceable changes, and responsible people, testing and verification as well as the quantitative evaluation, all of these provide best quality products with a lot of added value. It also helps in project maintenance. The integrator benefits from lower time to market, better safety analysis results, easier integration, and support. ◀



Author

Robert Nawrath
 Digital Core Design
robert.nawrath@dcd.pl
www.dcd.pl

Simplified ordering process for CiA 425 CANopen interfaces

CiA 425 specifies the CANopen interface between CT (computer-tomograph) scanner and contrast media injectors. Since several years, Medtron offers CiA 425 compliant injectors. Now, the company has assigned different article numbers, in order to distinguish interfaces for different scanners.

(Source: Adobe Stock)

The CANopen application profile for medical diagnostic add-on modules is specified in the CiA 425 document series. It is developed by the special interest group (SIG) contrast media injector working under the umbrella of CAN in Automation (CiA). Part 1 provides general definitions including the connector pin-out. Part 2 specifies the injector interface. There are two versions available: Version 2.4.0 is in draft specification proposal (DSP) status available for CiA members only; version 2.2.0 is in draft specification status and therefore part of the CiA 4XX series subscription by non-members.

Usually, the CT scanner manufacturers (e.g. General Electric (GE) Healthcare, Philips, and Siemens Healthineers) implement different optional CiA 425 functions. In the past, all Medtron injector variants were combined under one article number, which often led to confusion during the ordering process. Now, each CANopen injector variant has a unique IF (interface) article number, which expresses the compatibility to different CT scanners:

- ◆ IF864 – CANopen interface class 4 (Siemens Healthineers)
- ◆ IF864B – CANopen interface class 4 (GE Healthcare)
- ◆ IF864E – CANopen interface class 1 (Siemens Healthineers)



Figure 1: Introduced IF (interface) article numbers for CANopen injectors express compatibility to CT scanners from different manufacturers (Source: Medtron)

MDR certification

In order to guarantee the sale of injectors in the future, they must be equipped with the new European MDR certificates by January 2024. MDR stands for "Medical Device Regulation" and defines the requirements that manufacturers must meet in order to introduce and sell medical devices on the European market. The regulation is already in force and will successively replace the previous Medical Device Directive (MDD) by January 2024.

"What sounds so simple at first and still a long way off, represents an immense task now and in the coming months, especially for our development department," explained the company. As early as May 26, 2021, the technical documentation of Medtron Class I products (remote controls and CANopen interfaces) has been adapted to the MDR criteria. However, "adapting" is not enough here. For the most part, technical documentation must meet much higher, more detailed requirements than before and in some cases must be rewritten. Those for Class II products were to be completed by beginning of 2023. This was a sporting task that we were tackling with a high level of motivation," stated Medtron on its website.

The MDR is intended to ensure the safety of medical devices throughout Europe. Its primary purpose is to protect patients and it applies in all states of the European Union (CE area). "For our quality management, development department, product management, and sales department in particular, the implementation of the new requirements means that individual work processes have to be adapted or even completely revised," explained Medtron. "Since the intended use of the products must be described in more detail, the scope of the technical documentation for our products will also increase, which will subsequently also affect our sales partners."

In future, when preparing clinical evaluations, competitor products will have to be considered, technical equivalence will have to be demonstrated, and a clinical evaluation plan ▶

Transition period to MDR extended

On February 16, 2023, the European Parliament approved a proposal that will significantly ease the challenges of medical device manufacturers. With the latest extension of the EU 2017/745 MDR, they have the possibility to apply for an extension of the transition period for their products. The new regulation is expected to enter into force shortly through publication in the European Journal. Manufacturers will then have the prospect of the following transition periods:

- ◆ May 2026, 2026 medical devices (custom-made, class III)
- ◆ December 2031, 2027 medical devices (higher-risk, non-exempted class IIb implants and class III devices)
- ◆ December 2031, 2028 medical devices (low-risk)

will have to be drawn up. A new, extremely time-consuming process results from the requirement that the basic safety and performance requirements must be expanded and verified by the testing department.

Contrast media injection workflow optimized

The recently introduced IDS (injection data sharing) option enables the exchange of injection data with the digital radiology infrastructure. The CANopen interface synchronizes wirelessly between the injector and the CT scanner. On company's Youtube channel is a recent video on how IDS and CANopen work. The CANopen interface complies with the CiA 425 profile specification. This interface provides for the transmission of the injection parameters (volume, contrast concentration, flow rate, etc.) and the synchronized execution of the injection (start and stop).

The IDS software option, based on the DICOM standard, links the injection report with the patient data. Through IDS, users can directly access the modality worklist (patient worklist) stored in RIS using the injector. Once the examination is complete, the injection report (as a DICOM dataset) is automatically linked to the associated patient data and stored in PACS as structured report, secondary capture, or ePDF.

Additional partnerships

Since April 2023, Medtron cooperates with Röntgentekno (Imaqen) in Finland. The first conversation about the cooperation took place at the ECR European Congress of Radiology 2023 in Vienna. "With Röntgentekno (Imaqen) we are pleased to have a reliable partner at our side, which will enable us to place our product portfolio on the Finnish market in the future," stated Christoph Salzmann from Medtron. "The partnership is a perfect combination of innovative technology and medical expertise to bring radiology technology to a new level in Finland." Imaqen is owned by Röntgentekno, which was founded in 2008. The company provides products and services to healthcare professionals. The team has decades of experience in product development, manufacturing, international sales, and marketing of healthcare equipment, especially imaging equipment.

Additionally, Medtron reported its cooperation with Guerbet in Germany and Austria. With this collaboration, both companies aim to improve the workflow between Medtron's injectors and Guerbet's contrast management solution. In addition, Medtron will distribute Guerbet's Contrast&Care solution and Guerbet will distribute the contrast media injectors, in both directions on a non-exclusive basis.

"Our goal is to be a trusted and competent partner for the radiology community, understanding their challenges and providing value-added solutions. Working with Guerbet is the logical next step in achieving this goal and offering innovative, value-added solutions in an even more complete product portfolio. Adding Guerbet's high quality contrast management solution will achieve this," said Bjørn Jochems from Medtron.

"The collaboration with Medtron is an important milestone on Guerbet's path to continuously develop our portfolio. It is our commitment to provide innovative solutions that are serving our customers to cope better with their daily challenges. Together with Medtron we are aiming to improve data- and workflow as well as to enable analytics leading to an efficiency gain in radiology departments and imaging centers," said Achim Berlis from Guerbet. ◀

hz (based on information from [Medtron's website](#))

SIG contrast media injector

This CiA special interest group (SIG) has updated the CANopen profile for contrast media injectors. During the review process the group focused on the introduction of the multiple-injection protocol (MIP). The intent is to clarify and to simplify the handling of several consecutive injection protocols from the viewpoint of the medical diagnostic device (scanner). There is a probability that in the contrast media injector "unintended remainings" from the previous injection protocol could erroneously influence the processing of a new protocol. In particular historical parameter settings, adjusted with regard to a former injection protocol, could lead to an unintended and unsafe injector behavior. To avoid reprogramming

and reconfiguration of the injector, the scanner has now the chance to program the multiple-injection protocol, at once. This reduces potential sources for faulty configurations.

The extension of CiA 425 is introduced backwards compatible. An already existing injector implementation processes the MIP as a "traditional" single-injection protocol. New commands are rejected and treated as any other invalid command. The new version of CiA 425-2 is currently in the CiA-internal release process. In 2024, on occasion of the annual SIG meeting, the group will start focusing on cybersecurity issues.

Vertical farming as a promising future concept

In vertical indoor farming, ventilation, air conditioning, and automation solutions ensure that plants always have ideal conditions for growth. For such applications, EBM-Papst offers fans, drives, and automation solutions with CANopen connectivity.



Vertical indoor farming is regarded as an agricultural concept with a future. The yield per unit area is significantly higher, as the implemented systems enable required climatic conditions and can be operated throughout the year. Efficient and smart automation systems are essential for this.

To use the existing resources more efficiently, plants are produced above one another in buildings, containers, or in air-conditioned supermarket cabinets. This allows urban spaces to be used sustainably for agriculture, saving additional transportation time and costs. The potential of this technology can be only exploited if the light, nutrients, ventilation, temperature and humidity are right. The basic prerequisite for this are economic systems that always operate according to the demand, also in automated product handling and transport. EBM-Papst offers a number of smart fans and drives (including software) suitable for different vertical farming concepts. The specialist is also available as an engineering partner and system provider and offers support on complete automation solutions.

Ventilation and air conditioning

The concepts for ventilation and air conditioning include tunnel ventilation, which pushes the air through the building. However, central ventilation units installed on roofs

are also common as they provide individual plants or floors with a targeted air supply via pipe and tube systems. Different fans are required here. Compact axial fans move high air flows of up to 65000 m³/h and operate at back pressures of up to 1500 Pa. They are therefore particularly suitable for the tunnel supply. Centrifugal fans enable high back pressures up to 5200 Pa and air flow rates up to 30000 m³/h. Compact fans have proven their worth for air conditioning in supermarket cabinets, for ventilation of individual shelves and for cooling LEDs.



Figure 1: A hose ventilation system supplies the plants with air (Source: EBM-Papst)



Figure 2: Axial fans (left) e.g. for tunnel ventilation systems and centrifugal fans (right) typically implemented in central ventilation units (Source: EBM-Papst)

Drive solutions

Decentralized drive solutions reduce costs for transport or handling systems in vertical indoor farming. This ranges from automated product handling with autonomous driving vehicles to conveyor belts and access control systems. Such solutions rely on good control characteristics and precise positioning. Reliable, compact, and dynamic drive systems that withstand strong loads are required to open and close barriers, gates, and windows, for example. Drive systems with a high degree of networking possibilities are indispensable.

EBM-Papst offers a modular drive system for this application field, consisting of a motor, transmission (planetary or angular), and electronics. For example, the electronically-commutated ECI motors cover a power range from 30 W to 750 W in sizes 42 mm, 63 mm, and 80 mm. Different transmissions ensure the necessary reduction



Figure 3: The modular drive system enables standard solutions to be implemented for many applications (Source: EBM-Papst)

CANopen drive

Miniaturization and distributed intelligence are also current trends in plant engineering. Users are looking for compact, Industry-4.0-compatible drives that receive commands from higher-level controller via a network and return actual values and status to the control system. The compact ECI 63.xx K5 brushless DC motor with integrated electronics is suitable for demands in plant engineering. Variants with 180 W to 370 W are available.

As soon as the number of nodes in a system increases the proven CANopen device is the solution of choice. Systems interconnected via standardized CANopen interfaces offer cost advantages with regard to hardware and implementation. The integrated K5 electronics module equips the ECI 63.xx motor with a standardized CANopen interface. The drive implements the CiA 402 CANopen device profile for drives and motion control also internationally standardized in IEC 61800-7-201/-301. Supported are the operating modes for positioning, speed, current, and torque control. Interpolated positioning for cyclical set value requirements is also possible. Standardized homing methods and reduced-speed travel to mechanical stop (blockade) can be used to reference the drive position. An encoder system is integrated to resolve the drive shaft positioning as a 12-bit value.

Due to the integrated K5 electronics module, the drive is programmable like a PLC. Thus, it relieves the higher-level control system or can replace it in some cases. In CANopen networks, it can be used as a

CANopen NMT (network management) manager enabling standalone applications without a higher-level PLC. This allows to reduce system costs.

Using the Eptools startup and parameterization software, the drive can be configured via CANopen using a PC. The common parameters are visualized in the configuration window. Additional parameters can be added to the GUI (graphical user interface) and uploaded to the drive. The configured parameters set can be saved on a PC. The status window displays the relevant drive measurements and status information. In the activation window, users can operate the drive in various operating modes, enable the controller, and specify set values directly. They can also set digital inputs and outputs. Application-specific programs for integrated control can be compiled in a further window and uploaded to the drive.

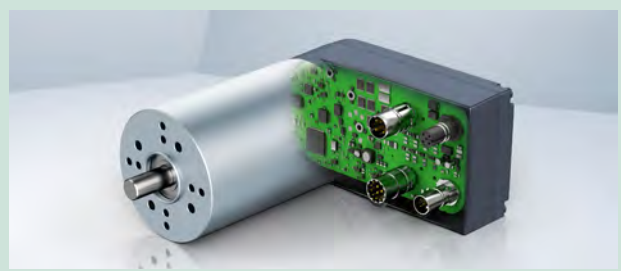

Figure: The ECI63 motor with an integrated electronics module provides a standardized CANopen interface (Source: EBM-Papst)



Figure 4: Digital services help to monitor growth conditions, initiate targeted changes, or quickly eliminate problems (Source: EBM-Papst)

ratio of the high-speed internal rotor motors. The modular drive system enables standard solutions to be implemented for many applications. For example, the ECI internal rotor motors are suited for use as shuttle traction drives, depending on the required power either in size 63 mm or 80 mm. They achieve high torques at 24 V_{DC} or 48 V_{DC}, and are able to deliver three times the nominal power for a short time. The K5 electronics module with a CANopen communication interface is installed in the drive. It enables the drive system to communicate with other connected drives or a PLC (programmable logic controller).

Real-time production monitoring

For a high-yield harvest, the conditions for growth must be continually monitored to initiate targeted changes or

quickly eliminate problems if required. EBM-Papst helps to achieve this using its digital services. Sensors and hubs ensure that all necessary data is digitized, whether it is the status of technical systems or monitoring of the air and water quality. This enables the data on air conditioning, nutrient supply, or lighting to be visualized in real time. For example, using an app, it is also possible to test settings or automatically receive current messages on a cell phone. The specially developed cloud applications provide the appropriate information and control options to optimize production and make it economical and sustainable. ◀

Authors



Jochen Scherer, Christian Stern, Patrick Schumacher
 EBM-Papst
info1@de.ebmpapst.com
www.ebmpapst.com/verticalfarming



Get the CAN-related knowledge!

Seminars	Date	Location
CAN for newcomers	2023-10-11	Online
CANopen for newcomers	2023-10-12	Online
CAN and CANopen for newcomers	2023-10-24	Lomazzo (IT)
CAN and CANopen for newcomers	2023-11-28	Nuremberg (DE)

Subject to change without notice.

Technology days	Date	Location
Chinese technology day	2023-09-14	Online
CiA technology day	2023-10-25	Lomazzo (IT)
CiA technology day	2023-11-21	Kaohsiung (TW)

Webinars	Date	Location
CANopen Lift	2023-09-14	Online
Future of CANopen technologies	2023-10-25	Online

For details, please contact CiA office: events@can-cia.org
 We are looking forward to your registration.
www.can-cia.org

Standards and specifications



This section provides news from standardization bodies and nonprofit associations regarding CAN-related documents. Included are also recommended practices, application notes, implementation guidelines, and technical reports.

Revision of ISO 11898-1 and ISO 11898-2

CiA has submitted several specifications to be included in the ISO 11898 standard series. Therefore, the standards ISO 11898-1 (CAN data link layer and physical coding sublayer) and ISO 11898-2 (CAN high-speed physical medium attachment sublayer) are under revision. Both documents are currently in Draft International Standard (DIS) status. This means you can buy them in the [ISO webstore](#) or purchase them from your national standardization body (in Germany from the [Beuth Verlag](#)).

The ISO DIS 11898-1:2023 document specifies all three CAN protocol generations: classical CAN, CAN FD, and CAN XL. In the annex, the document specifies the CAN FD Light protocol, a variant of CAN FD. CAN FD Light is intended for commander/responder applications providing a cost-effective solution for simple network applications similar to LIN, but requiring more throughput. The CAN XL and the CAN FD Light protocols were pre-developed by CiA members. With the release of the ISO DIS 11898-1:2023 document, CiA has withdrawn the CiA 610-1 (CAN XL) and CiA 604-1 (CAN FD Light) specifications. This DIS ballot is still ongoing and terminates mid of September. Depending of the submitted comments by the voting national standardization bodies, the document will be released directly as ISO 11898-1 standard or there will be an FDIS (Final Draft International Standard) ballot. An FDIS ballot is necessary, when significant technical changes are requested by the submitted DIS comments.

The DIS ballot of the revised ISO 11898-2 standard resulted in significant technical changes. This means, an FDIS ballot is needed. The ISO FDIS 11898-2 document

will be submitted, soon. The revised document specifies the normal high-speed transceivers, the transceivers with signal improvement capability (SIC), and those with CAN SIC XL functionality using PWM (pulse-width modulation) coding. Therefore, CiA has withdrawn the CiA 601-4 (SIC) and CiA 610-3 (SIC XL) specifications. The FDIS ballot will start, soon. Technical comments are not allowed, the national standardization bodies can only vote positively or negatively, but may still submit editorial comments. hz

CiA SIG welding and cutting established

CiA members have established the Special Interest Group (SIG) welding and cutting. The SIG chaired by Dr. Andreas Matz from Abicor Binzel is going to develop the open CiA 464 interface framework for advanced manual arc welding and plasma cutting systems. The SIG comprises representatives from different manufacturers of related equipment. This includes suppliers of power source, fume extraction, and torch units. The framework provides plug-and-play functionality for basic setups, which includes physical layer requirements such as cables and connectors.

The resulting system provides contradiction-free data to the Asset Administration Shell (AAS) as well as facilitates regulatory compliance and protecting the worker's health. The SIG has identified the interfaces for several functions that will be covered by the CiA 464 application profile for welding and cutting. The functions will be specified by the following Task Forces (TF):

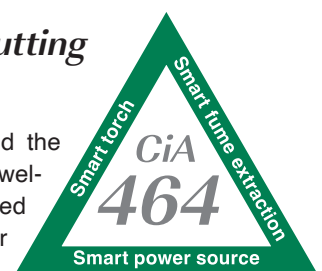

- ◆ System architecture and protocols (TF01);
- ◆ Power source, wire feeder, cooling, and calibration units (TF02);
- ◆ Human machine interface unit (TF03);
- ◆ Torch unit (TF04);
- ◆ Fume extraction unit (TF05).

In a first step, the CiA 464 profile will be mapped to classic CANopen. CiA cooperates with EWA (European Welding Association) and ZVEI (German Electro and Digital Industry) to develop and promote the CiA 464 application profile for welding and cutting. *hz*

Brief news

IEC TS 61851-3 series: This set of IEC Technical Specifications (Electric vehicles conductive power supply systems for light electric vehicles) describes the requirements for a CANopen-based profile. It originates from the CiA 454 application profile series. It includes parameter specifications and defines also a connector.

CiA 106: The new version 1.1.0 has been editorially improved and provides definitions for CANaero-space connectors. The main purpose of this technical report is the recommendation of pin-assignments for CAN_H and CAN_L as well as for a common ground. Some pin-assignment recommendations also define the pins for power supply.

SAE J1939DA: As usual, SAE has updated the Digital Annex (DA) for J1939. The July 2023 issue of this spreadsheet contains Suspect Parameter (SP) and Parameter Group (PG) specifications. The DA is updated quarterly. It is part of the one-year SAE on-board diagnostics for light- and medium-duty vehicles [subscription](#).

CiA 401 series: CiA has restructured the document series of the CANopen profile for modular I/O devices. Part B specifies the functional behavior and process data parameters. Part C standardizes the mapping to the classic CANopen application layer (CiA 301) and Part F specifies the mapping to the CANopen FD application layer (CiA 1301). The specification for joysticks is annexed.

CiA 462: The CANopen profile for item detection devices has been editorially reviewed and is now available as CiA Draft Specification (DS). This means, the document is part of the CiA 4XX subscription, which is available for CiA non-members, too.

ISO 11783-2/-3: The so-called Isobus physical layer (ISO 11783-2) and Isobus application (including transport and network layer) layer (ISO 11783-3) standards are in revision. Isobus is based on the J1939 application layer, but uses an adapted transport layer. The documents need to be improved editorially, in order to avoid misunderstandings and misinterpretations.

3,3-V CAN transceiver specification: CiA is discussing the need of standardizing 3,3-V CAN transceivers. In September, the IG (interest group) lower layers is going to evaluate this topic. *hz*



CAN in Automation

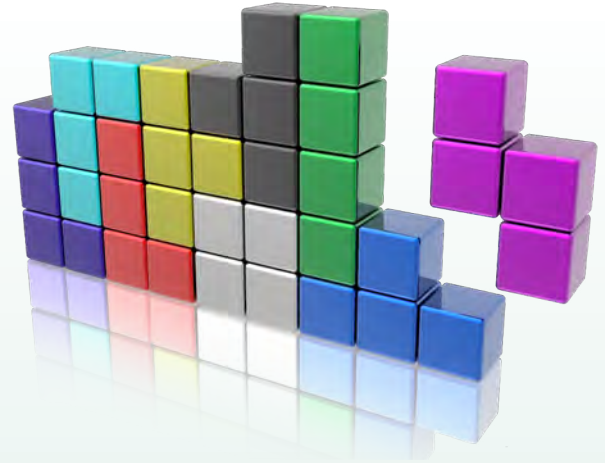

Join now!

Do not miss your chance and join CiA marketing opportunities.

► Sponsorship at 18th international CAN Conference (iCC)

► Table top exhibition at 18th iCC

► CiA product panels at Interlift 2023

► CiA product panels at SPS 2023

► CiA publications



*For details please contact CiA office:
publications@can-cia.org*

www.can-cia.org



CAN in Automation

The nonprofit CiA organization promotes CAN. CiA and its members shape the future of CAN-based networking, by developing and maintaining specifications and recommendations for classical CAN, CAN FD, and CAN XL.

Join the community!

- ▶ Access to all CiA specifications, already in work draft status
- ▶ Get CANopen vendor-IDs free-of-charge
- ▶ Develop partnerships with other CiA members
- ▶ Participate in plugfests and workshops
- ▶ Receive the exclusive, monthly CiA Member News (CMN) email service
- ▶ Initiate and influence CiA specifications
- ▶ Get credits on CiA training and education events
- ▶ Get credits on CiA publications
- ▶ Get the classic CANopen conformance test tool
- ▶ Participate in joint marketing activities
- ▶ Get credits on CiA testing services

*For more details please contact CiA
office at headquarters@can-cia.org*

www.can-cia.org