

March 2017

# CAN *Newsletter*

*Hardware + Software + Tools + Engineering*



25<sup>th</sup> anniversary

[www.can-newsletter.org](http://www.can-newsletter.org)

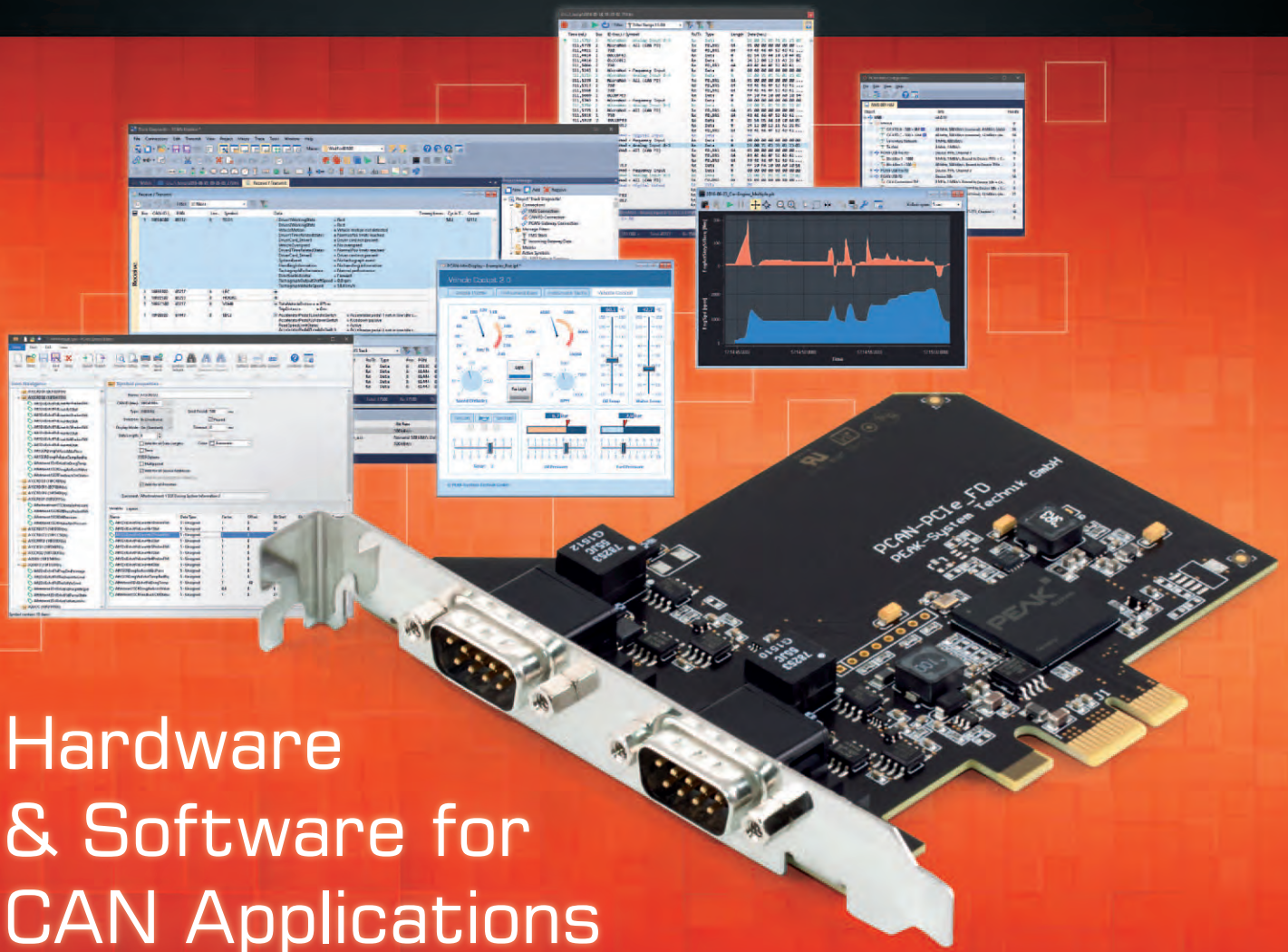

# Hardware & Software for CAN Applications

## ■ PCAN-Explorer 6

Professional CAN Communication Software

The PCAN-Explorer is a versatile, professional Windows® software for the observation, control, and simulation of CAN busses. Besides CAN 2.0 A/B, the PCAN-Explorer 6 now also supports the CAN FD standard.

- Simultaneous connections with multiple CAN interfaces independent of their hardware type
- Support for the CAN specifications 2.0 A/B and FD
- Transmission of CAN FD data with bit rates up to 12 Mbit/s
- Clear display of the CAN traffic with various information
- Configurable symbolic message representation
- Easy manual and periodic message transmission
- Data logging with tracers and the 4-channel Line Writer
- Playback of trace files with optional loop function
- Multiple flexible filters, also usable for recorded trace files
- Management of settings, information, and files in projects
- Export of entire projects including linked files to handy packets for archiving or sharing
- Automation of small tasks or complex processes with macros or VBScript
- Functionality upgrades with add-ins

■ **Now:** Basic training for groups or individuals. If you are interested, please contact [training@peak-system.com](mailto:training@peak-system.com).

## ■ PCAN-PCI Express FD

CAN FD Interface for PCI Express

The CAN FD interface PCAN-PCI Express FD is a plug-in card (PCIe-x1) for the PCI Express slot with data transfer rates up to 12 Mbit/s. Delivery includes a monitor software, APIs, and drivers for Windows® and Linux.

- Available with 4, 2, or 1 High-speed CAN channels (4 channel version expected to be available in Q1 2017)
- Complies with CAN specifications 2.0 A/B and FD
- CAN FD support for ISO and Non-ISO standards switchable
- CAN FD bit rates for the data field up to 12 Mbit/s
- CAN bit rates from 25 kbit/s up to 1 Mbit/s
- CAN bus connection via D-Sub, 9-pin (in accordance with CiA® 303-1)
- Galvanic isolation on the CAN connection up to 500 V, separate for each CAN channel
- CAN termination and 5-Volt supply at the CAN connection can be activated, separately for each CAN channel
- PCIe data transfer via bus master DMA. DMA memory access operations with 32- and 64-bit addresses
- Extended operating temperature range from -40 to 85 °C
- Measurement of bus load including error frames and overload frames on the physical bus
- Induced error generation for incoming and outgoing CAN messages



Meet us in hall **1**, booth **483**

PEAK-System Technik GmbH

Otto-Roehm-Str. 69, 64293 Darmstadt, Germany  
Phone: +49 6151 8173-20 - Fax: +49 6151 8173-29  
E-mail: [info@peak-system.com](mailto:info@peak-system.com)

[www.peak-system.com](http://www.peak-system.com)





## 25<sup>th</sup> anniversary

CAN tools – then and now	4
The dawn of CAN	8
From 1992 to 2017: CiA's 25 <sup>th</sup> anniversary	12

## Imprint

### Publisher

CAN in Automation GmbH  
Kontumazgarten 3  
DE-90429 Nuremberg

[publications@can-cia.org](mailto:publications@can-cia.org)  
[www.can-cia.org](http://www.can-cia.org)

Tel.: +49-911-928819-0  
Fax: +49-911-928819-79

CEO Holger Zeltwanger  
AG Nürnberg 24338

**Printed in Germany**  
Copies: 1500

**Downloads December issue:**  
(retrieved 2017)  
4000 full magazine

### Editors

[pr@can-cia.org](mailto:pr@can-cia.org)

Cindy Weissmueller  
Holger Zeltwanger  
(responsible according  
to the press law)

### Layout

Nickel Plankermann

### Media consultants

Gisela Scheib  
(responsible according  
to the press law)  
Gertraud Weber

### Distribution manager

Holger Zeltwanger

### © Copyright

CAN in Automation GmbH



## Applications

Back to the future	16
Service robots: Modular and battery-powered	26
Service robots with CAN-driven devices	30
Amsterdam brewer's drayman go electric	50



## Devices

Steppers versus servos	34
CAN in China: Still just a few local suppliers	38
Data on wheels and in the cloud	56
CANopen interface for vacuum pump	60
Wire it up with CANopen	62



## Engineering

Adventures of a CANopen consultant	22
Safety CAN: Why and how?	42
Autosar SecOC for CAN FD	44
Ada language for automation	46
Automotive Ethernet for mobile machines	52

## Happy birthday!

It is unbelievable how time flies. Me, and also the CAN Newsletter are celebrating our 25<sup>th</sup> birthday this year. Maybe it was kind of a sign that the first issue got published in June 1992, a few days before I came into the world, too? What a pity that I wasn't able to read it back then yet. Anyway, I hope you are enjoying the 25<sup>th</sup> anniversary issue and if you want to be part of the next edition, just contact me at [pr@can-cia.org](mailto:pr@can-cia.org). I look forward to it!

Have a nice day,  
Cindy Weissmueller  
Editor of the CAN Newsletter



# CAN tools – then and now

*This article leads us from the modest beginnings of the CAN tools and the past challenges to the currently achieved state and the emerging trends for the future.*



*Figure 1: From the early days of CAN tools on the joint CiA booth at Hanover Fair 1993 (Photo: Vector)*

The possibilities of a bus system can only be fully utilized in combination with powerful software tools for development, diagnostics, and support. In parallel with the rise and advancement of the CAN network, therefore a significant infrastructure comprising tools for bus analysis, management of communication data, development, and simulation of bus nodes and much more has become established. This article leads us from the modest beginnings of the CAN tools and the past challenges to the currently achieved state and the emerging trends for the future. When the first vehicles with CAN in the drive train went into series production in 1990, even specialists were surprised by the robust and trouble-free operation demonstrated by the new bus system in actual use. Troubleshooting in the modern vehicles, however, proved to cause considerable problems for developers and repair shops. This was due, on the one hand, to the lack of know-how in the area of bus technology and networked electronics and, on the other hand, to the lack of suitable tools for bus diagnostics. In some cases, this helplessness resulted in vehicles needing to be sent to the factory for error analysis. There, the development engineers used provisional tools to try and localize errors and document the procedures.

Work on bit-level and with hex representations was, at this point in time, both inefficient and without alternative.

## First technically adequate CAN tool

The engineers at Vector soon recognized this problem and began developing a user-friendly CAN tool for the motor vehicle sector in 1991. The application area of this software with the catchy name “CANalyzer” covered both development as well as troubleshooting. With completion of the first prototype in spring of 1992, Vector learned from the press about the founding of CAN in Automation (CiA), whose original roots lie in general automation. After immediately contacting Holger Zeltwanger, CiA co-founder, Vector became a very early member of the CAN user organization in April 1992. On the periphery of iNet in Sindelfingen, Germany, in June of 1992, the first CiA meeting with Vector in attendance was held. At the same time, the company presented CANalyzer to the public for the first time at this trade fair, a tool that finally allowed developers to work in a comfortable, technically adequate manner. The author of this article regularly gave lectures at CiA events and held training courses on the topic of CAN in the following years. ▶



Figure 2: CAN analysis 1993 – Compaq Portable with ISA-CAN interface card (Photo: Vector)

The computer and software world of that time was significantly different from that of today. Typical PCs were IBM PC/AT compatible computers equipped with 80386-CPU, clock speeds of 25 MHz and 1 MiB of RAM, while the operating system of choice was called MS-DOS. Portable computers also existed at that time, but they were truly heavy “boxes” which looked more like a sewing machine than a computer system (Figure 2). At nearly the same time as the CANalyzer presentation, Microsoft Windows 3.1 was launched on the market in early 1992. The predecessor versions of this operating system were found to be much too slow and unreliable for technical software with real-time requirements.

Vector’s CAN tool was still based on MS-DOS, but had a self-developed and fast graphical operating system with window management that had already proven itself in calibration tools developed for Bosch. This was a decisive advantage over the text-based MS-DOS tools from other producers, as it offered much better user guidance. Installation was very simple: The user simply copied the approximately 1 MiB of content located on a diskette to a PC directory, selected the correct graphics driver (Hercules, EGA, or VGA) and started an EXE file. Today, a single digital photo is about four times larger than the content of the installation diskette of the first CANalyzer version. For bus coupling, only ISA cards from Bosch and Daimler-Benz were initially available. For this purpose, the specialist secured the sales rights, in order to supply other users of CAN tools with the right hardware as well.

Depending on one's perspective, the first version of the tool can be characterized, on the one hand, as spartan and, on the other hand, as rather progressive. For example, the functionality of the first interface boards with the so-called FullCAN controllers (Intel AN82526) was still noticeably restricted. It only allowed the reception of messages whose identifiers the developer had previously entered in the object list of the controller. For the automotive ECUs of the time, the automatic reception of CAN messages on this basis was a great advantage, as the low-performance micro-controllers were not unnecessarily burdened. Universally usable CAN tools were, however, severely impaired as a result. Progressive, on the other hand, was the ability to freely program the tool. The self-developed programming language, CAPL, enabled developers and testers to both generate as well as manipulate CAN traffic. With the help of simple scripts, it was – even at that time – possible to generate correct as well as faulty data traffic for testing and stimulating test samples. ▷

## PC/CAN Interfaces



### Easy CAN connection for your application

- Interface for your control or monitoring application as well as for the IXXAT tool suite
- All PC interface standards supported with one uniform driver interface
- Drivers (32/64 bit) for Windows 7/8/10, Linux, QNX, INtime, VxWorks and RTX
- APIs for CANopen and SAE J1939



Discover more:  
[www.all4CAN.com](http://www.all4CAN.com)



CAN-IB 100/200/PCle  
1-4 x CAN (HS/LS)



CAN-IB 130/PCle 104  
2-4 x CAN (HS)



CAN-IB 120/PCle Mini  
1-2 x CAN (HS/LS)



CAN@net II - Ethernet  
PC interface, bridge, gateway  
1 x CAN (HS)



CANblue II - Bluetooth  
PC interface, bridge, gateway  
1 x CAN (HS)

HMS Industrial Networks GmbH  
Emmy-Noether-Str. 17 · 76131 Karlsruhe

+49 721 989777-000 · [info@hms-networks.de](mailto:info@hms-networks.de)  
[www.anybus.com](http://www.anybus.com) · [www.ixxat.com](http://www.ixxat.com) · [www.ewon.biz](http://www.ewon.biz)





Figure 3: Network analysis today – Tablets offer mobility and performance (Photo: Vector)

A great improvement in convenience came just a year later in 1993 with interface cards that were specially developed for CAN tools. They worked with simpler CAN controllers and could receive all messages. This, in turn, then required “high-performance” micro-controllers on the cards. Even if it might be a matter of course today, at this time it was a massive challenge to transfer the data of two high-speed CAN networks to the PC with 1 Mbit/s and 100 % bus loading without loss of messages.

The Vector tools brought a significant improvement in operation and convenience with the implementation of the CANdb data format. It is used to store and manage all parameters, messages, and signals of pre-configured CAN networks. In particular, the system permits the use of symbolic designations for messages and signals and it supports the conversion of raw bus data into physical quantities. Temperatures, for example, can be presented directly in degrees Celsius instead of in cryptic binary values, the enumeration values of codes can be displayed and much more. CANdb now gave users the ability to work with expressive and familiar designators, making coding details and ambiguous data fields in hexadecimal numbers a thing of the past. Other tool producers quickly realized this as well. As a result, CANdb soon became the de facto industry standard for pre-configured CAN networks.

The simulation of not yet implemented ECUs’ bus traffic and even complete network topologies with CANoe (CANopen environment) in 1995 marked another milestone in the history of CAN tools. For ECU developments, these remaining bus simulations are the prerequisite for realistic tests which provide information on the behavior and maturity level of the test sample, even if the final environments do not yet exist. In the meantime, Windows had established itself as the dominant PC operating system and the significantly faster Pentium-based computers finally allowed it to be used with tools.

### From specialized CAN profile to multibus tool

Through the rapid proliferation of the CAN network in both the automotive sector and in areas such as factory automation, medical technology, railway technology, and commercial vehicle technology or aviation, numerous CAN-based higher-level protocols and profiles became established.

Vector responded to this development with a series of protocol-specific variants of its CAN tools. Among the most important were the options SDS (Honeywell), Devicenet (Allen Bradley), and CANopen (CiA) for automation technology, J1939 for the commercial vehicle sector as well as CANaero for the aviation industry.

In parallel, the automotive industry developed the specialized network systems LIN, Most, and Flexray, which were no longer based on CAN. It was now a matter of expanding the existing CAN tools accordingly and giving the users the ability to continue to perform their tests and measurements in the multibus environments of the modern vehicles using the tools with which they were familiar. The highly accurate capturing, synchronization and processing of the numerous messages and signals from the various parallel bus systems continues today to be one of the greatest challenges for a tool producer.

With CAN FD (CAN Flexible Data Rate), Bosch presented an interesting successor to Classical CAN in 2012. The main new features are a user data length that was expanded from 8 bytes to 64 bytes as well as the ability to switch to significantly higher data transmission rates. While, in the opinion of specialists, CAN will continue to be a factor for at least ten more years, the series introduction of CAN FD is just around the corner and the next generations of vehicles from various manufacturers will be equipped with it. One big advantage of CAN FD is that the existing CAN concepts such as bus arbitration, message detection, event control, etc., are retained and the developers do not need to deal with a completely different behavior. The same holds for the integration of CAN FD in the tools.

A switch to automotive Ethernet, on the other hand, involves significant changes in the familiar ways of working and thinking. The high bandwidth of Ethernet is essential for intelligent ADAS applications (Advanced Driver Assistance Systems) as well as future autonomous driving. The systems use so-called environmental models, which continuously are to be fed with large quantities of data by on-board cameras, radar sensors, etc. Instead of using a physically connected common bus system, with Ethernet one uses a distributed logical network made up of numerous switches and electrical point-to-point connections. This necessitates entirely new approaches both by network and ECU developers as well as by vehicle manufacturers. On top of this comes the handling of the significantly greater volume of data. While the previous automotive networks are defined largely statically, in future applications – especially in combination with Ethernet – service-oriented communication will play an important role. This results in ►

#### Related articles

- ◆ [Marc Lobmeyer, Roman Marktl \(Vector\): Tips and tricks for the use of CAPL \(part 1\)](#)
- ◆ [Marc Lobmeyer, Roman Marktl \(Vector\): Tips and tricks for the use of CAPL \(part 2\)](#)
- ◆ [Marc Lobmeyer, Roman Marktl \(Vector\): Tips and tricks for the use of CAPL \(part 3\)](#)
- ◆ [Mirko Donatzer \(Vector\): Eye diagram analysis for CAN FD](#)

## About the author

With respect to the CAN network, Martin Litschel can certainly be considered a pioneer. In the 1980s, he played a key role at Robert Bosch in defining the CAN protocol and was also involved in the first semiconductor implementation; he then led the development group beginning in 1987. Just one year later, he left Bosch and, together with two friends, founded Vector Informatik. Until 2014 he was responsible there for hardware and network tool development as executive director. Today he is involved with Vector as authorized officer and is active on the Vector foundation as foundation trustee.

greater flexibility and reusability of function units; new platforms can thereby be quickly assembled using the modular concept. On startup, the ECUs then communicate which network nodes are interested in which information and who can supply the information.

## What history teaches us

In spite of modern computers with multi-core CPUs and computing power and memory sizes that are about 1 000 times greater, today's challenges differ very little from those in the early stages of CAN. The fight for performance remains and the available resources are always pushed to the limits. Today's tools (Figure 3) must be able to handle extreme real-time requirements with reaction times in the sub-microsecond range. The required data transmission rates are about 100 Mbyte/s, i.e., approx. 1 000 Mbit/s. Here as well, we again encounter the factor of 1 000, if one thinks back to the 1 Mbit/s of the first CAN tools. Compared to the single diskette that held the first CANalyzer, a current full-installation of CANoe/CANalyzer with all options has a data volume in excess of 3 GiB, which would be equivalent to approximately 2 000 of the above mentioned installation diskettes.

Vector congratulates CiA on its 25<sup>th</sup> anniversary and is thankful for the excellent collaboration over the many years. We can only speculate on what communication systems will bring in the next 25 years and what the data networks will look like. CAN and, above all, CAN FD have the chance to continue to play an important role in the coming decades. ◀

## Author



Martin Litschel  
 Vector Informatik  
[martin.litschel@vector.com](mailto:martin.litschel@vector.com)  
[www.vector.com](http://www.vector.com)

# CAN Repeater, Bridges and Gateways



**CAN@net NT 200**  
 CAN-to-Ethernet  
 gateway/bridge with  
 2 CAN channels

## Interconnect your CAN devices and systems

- Save costs due to simple wiring
- Increase your system reliability and protect devices by galvanic isolation (up to 4 kV)
- Backbone bus to set up multi-channel solutions
- Filter/conversion functionality – no programming!
- Bridging of large distances and easy system access using Bluetooth, Ethernet...



Discover more:  
[www.all4CAN.com](http://www.all4CAN.com)



**CAN-CR220**  
 CAN repeater (4 kV galv. iso.)



**CAN-CR 210/FO**  
 FO repeater (F-SMA or ST)



**CANblue II - Bluetooth**  
 PC interface, bridge, gateway



**IXXAT CME/PN**  
 Profinet-CANopen-Gateway



**CANbridge**  
 (DIN rail or aluminum case)

HMS Industrial Networks GmbH  
 Emmy-Noether-Str. 17 · 76131 Karlsruhe

+49 721 989777-000 · [info@hms-networks.de](mailto:info@hms-networks.de)  
[www.anybus.com](http://www.anybus.com) · [www.ixxat.com](http://www.ixxat.com) · [www.ewon.biz](http://www.ewon.biz)



# The dawn of CAN

*CAN in Automation was founded 25 years ago, but CAN is even older than that. It's been a long way from CAN's development in 1984 to its recent update to CAN FD.*

International Congress and Exposition  
Detroit, Michigan  
February 24—28, 1986

## Automotive Serial Controller Area Network

860391  
Uwe Klencke,  
Siegfried Dais,  
and Martin Litschel  
Robert Bosch GmbH

Figure 1: SAE paper 860391 (Photo: Bosch)

In the eighties, the functionality of automotive systems was greatly improved by the introduction of electronics. Electronic engine management impressively reduced fuel consumption and exhaust emissions at the same time, while ABS optimized braking distance and improved vehicle control. Following improvements in automotive electronics required linking different functions together, which operated separately before that. At that time, the interconnections needed a plurality of separate signal lines. The complexity of the cabling increased costs and caused difficulties for the conventional electrical connections regarding space limitations, reliability, and accessibility. By 1990, high-end vehicles had up to 100 cable connections to the dashboard. This rising intricacy was barely manageable. A fast serial communication link was needed to provide suitable communication between real-time controllers, sensors and actuators in cars, transmitting the information in a coded form, while requiring as few connector pins as possible. The conditions in the vehicle make specific requirements of a bus system:

- ◆ Bus access priority must be granted dependent upon the importance of the information to be transferred.
- ◆ Short transfer times, high error immunity, and a computer load as low as possible must be guaranteed.
- ◆ A large number of different messages must be able to be processed.
- ◆ The overall costs of the system should be as low as possible.

The serial communication systems that were known at that time only partially met the requirements of the automobile industry. Simple interfaces such as UART (Universal Asynchronous Receiver/Transmitter) did not offer adequate performance. Expensive and complex communication systems such as those used to couple mainframes (Local Area Networks) were not suitable for coupling

controllers in vehicles. These systems do not have real-time capabilities and were too expensive.

To bridge this performance and cost-related gap, Bosch developed a new serial communication protocol specifically with a view to in-vehicle data transfer: CAN. The main part of the development was done in 1984 and was immediately followed by the design of the first CAN implementation, in cooperation with Intel. The first publication on CAN was presented in February 1986 at the SAE conference in Detroit. At the same conference, Bosch and Intel released a press statement announcing the first CAN controller IC. In 1987, the Intel 82526 consisted of 30 000 transistors, had a size of 20 mm<sup>2</sup> in a 44-pin package and was produced in 1,5  $\mu$  CHMOS III technology. It was a so-called full-CAN controller, meaning that it stored received messages in dedicated messages buffers, depending on the results of acceptance filtering.

CAN was an immediate success, several other IC implementations followed soon (e.g. Philips, Motorola), and it was integrated into  $\mu$ Cs. The second CAN IC (Philips 82C200) was a so-called basic-CAN controller, meaning that it stored received messages in a FIFO. The conformity of all CAN implementations was helped by standardization (ISO 11898) and by Bosch's

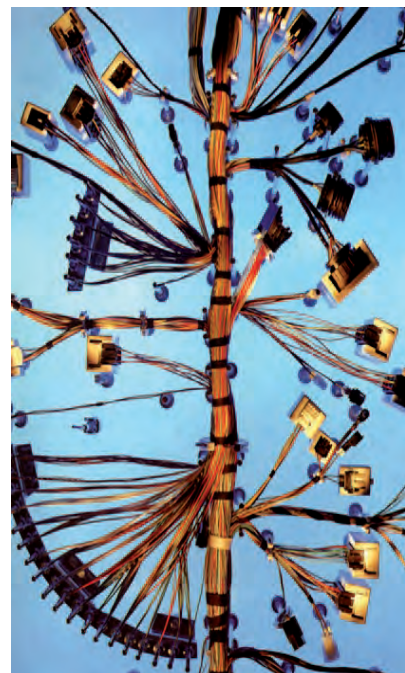

Figure 2: Typical CAN wiring harness (Photo: Bosch)



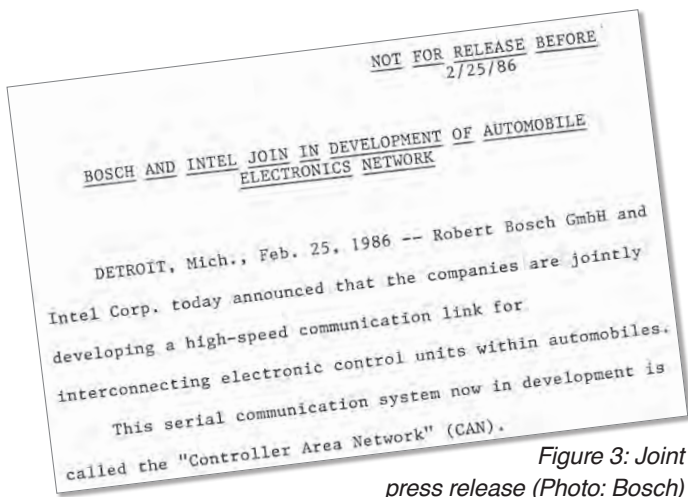

Figure 3: Joint press release (Photo: Bosch)

simulative reference model for verification. The first CAN evaluation boards and design tools arrived with the first silicon, allowing everyone to experiment with CAN networks.

The performance, robustness, and simplicity of CAN, combined with the multi-sourced availability of CAN controllers, created interest not only from the originally targeted automotive industry, but also from other areas, most prominently industrial automation. Even before the first automotive CAN application reached the market (five CAN nodes in the Mercedes-Benz S-Class of 1990, W140), CAN was used in several industrial control networks. At first, they were implemented using proprietary higher-layer protocols, but soon the first standards appeared, like CAN Kingdom, Devicenet, and SDS (Smart Distributed System).

This was also the reason for the founding of CAN in Automation 25 years ago: an organization for the joint development of standards around CAN and a meeting place for users and suppliers of CAN silicon, tools, and applications. CiA first standardized CAL (CAN application layer), which was the basis for the European research project ASPIC that developed CANopen. CANopen is now maintained by CiA and has been established as the main higher-layer protocol for CAN in industrial applications, leaving only minor roles for its predecessors.

The rapid spreading of CAN into other applications, combined with the long development cycles in the automotive industry, had the astounding consequence that the number of CAN nodes produced in industrial automation was larger than the number of CAN nodes in cars, until CAN was introduced into the high-volume cars in the mid-nineties. The experience from the first CAN networks merged into two updates of the CAN protocol: CAN 1.2 (1990) increased the oscillator tolerance, allowing the use of ceramic resonators and CAN 2.0 (1991) introduced the extended identifiers. These 29-bit long identifiers are needed to map predefined identifier sets for open architectures (e.g. SAE J1939). This concept allows nodes to be added or replaced in a network without needing to change the setup of the remaining nodes. The CAN controller Intel 82527 (1992) was the first implementation of CAN 2.0. In the beginning, some other protocols were considered for vehicle networks, but those did not go into production (Abus) or they were phased out again (J1850, ▷

## Multifunctional Power Pack!



# STW

**ESX-3CM** Freely programmable central control unit

- Development with CODESYS and „C“
- Large switching capacity up to 15A
- Flexibility through multifunction I / O's
- Extensive communication interfaces
- Suitable for rough environments
- Starter-Kit for easy and simple setup

### Exhibition Dates



**Hannover Messe Industrial Automation**, Hanover  
24.04. – 28.04.2017



**Sensor + Test**, Nuremberg  
30.05. – 01.06.2017



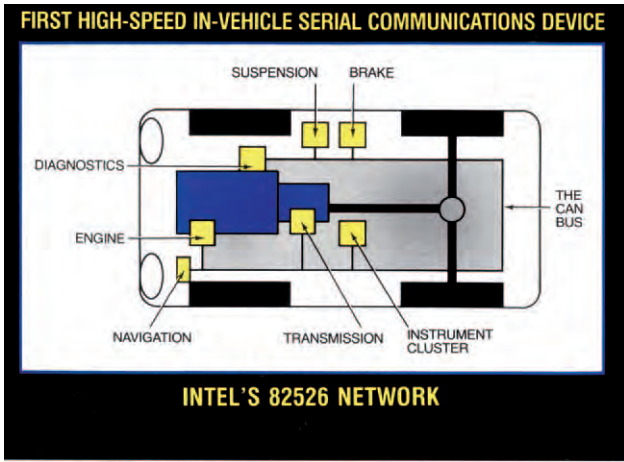

# 82526 primer

## Automotive High-Speed Serial Communication Is Now A Reality

The 82526 is the first integrated circuit in the world which allows automotive manufacturers to implement in-vehicle serial communication (sometimes referred to as "multiplexed" communication) between all in-vehicle control modules, such as engine, transmission, brake, instrument systems . . . Such a capability will accelerate the replacement of the wiring harnesses that limit the ability to efficiently use in-vehicle electronics.

Order Number: 270576-001

## The 82526 Implements The Automotive Optimized "CAN" Protocol

The 82526 peripheral integrated circuit implements a high-speed automotive specific serial communication protocol. Its function is to manage the communication between microcontrollers or processors on a serial bus, via twisted pair, coaxial or fiber optic cables. The set of serial communication rules (protocol) implemented on the chip was introduced in February 1986 at the Society of Automotive Engineers trade show by Robert Bosch GmbH and Intel Corporation. The protocol is called "CAN" for Controller Area Network. "CAN" has specifically been engineered to meet the requirements of automotive communication between in-vehicle electronic modules.

Figure 4: Intel 82526 advertisement (Photo: Bosch)

VAN). Ten years after the first CAN network, few cars did not use CAN, and most had several CAN networks for different functions.

When CAN entered automotive volume production, it turned out that the structure of the car's wiring harness did not agree with the original idea of how to build a CAN line: the so-called ISO-topology with terminations at both ends of the bus line and all nodes connected by short stubs. A wiring harness is usually pre-produced in an "E"- or "H"-shape, so most CAN networks are built as passive star networks. This degrades the signal quality, which is why most automotive CAN networks use a bit-rate of 0,5 Mbit/s instead of the 1 Mbit/s for which the CAN protocol was designed. At the lower speed, the robust CAN protocol can easily tolerate the ringing introduced by the bus topology.

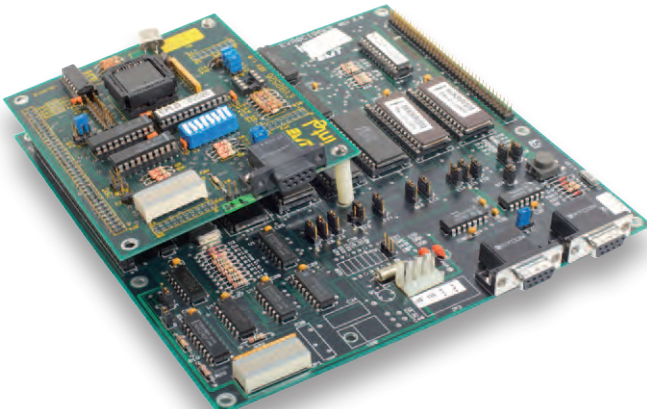

Figure 5: The 82526 evaluation board (Photo: Bosch)

The higher bit-rate is still used in so-called "Private CAN" networks: point-to-point connections between two nodes. While the first CAN networks used discrete transistors as bus line drivers, this was soon followed by dedicated CAN transceiver ICs. Different transceiver types were developed, but ISO 11898-2:2016 is now the standard in automotive applications, with or without the partial networking extension where the transceiver is able to decode wakeup messages. In industrial applications, galvanically isolated CAN transceivers are preferred.

Besides the first two fields of application, several other industries specified their own CAN standards, like Arinc-825 for aviation and ESA's ECSS-E-ST-50-15C for on-board spacecraft communications and control systems. This enabled CAN networks to reach the Moon (Smart-1, 2004) and Mars (ExoMars, 2016). In the automotive world, CAN remains the predominant bus system, although some other protocols have been added for specific applications, like LIN for master-slave sub-networks and MOST for infotainment. Ethernet was also introduced into automotive applications, first only for tasks with high data volumes, but lately also for control applications.

One specific automotive protocol, Flexray, has been added to CAN networks. Flexray was developed for x-by-wire systems, where mechanical and hydraulic linkages are replaced by bus systems, so that the car can be controlled with a joystick. These control loops require synchronized nodes communicating on redundant channels. Flexray was developed by the Flexray consortium targeted for a bit-rate of up to 10 Mbit/s. As with CAN, the network topology needs careful consideration to achieve high bit-rates; Flexray at 10 Mbit/s requires active stars or linear bus lines with a limited number of nodes. A time-triggered extension of the CAN protocol (TTCAN) was developed for the same x-by-wire applications. TTCAN has been standardized as ISO 11898-4:2004. The targeted x-by-wire systems never appeared in volume produced cars, so time-triggered communication lost its main purpose and the ECUs still operate with event-driven control messages.

The ever increasing need for bandwidth in automotive control networks raised the number of CAN networks in a car, requiring gateways and a backbone for interconnection. While Flexray is already used as such a backbone, its time-triggered communication schedule is not easily integrated into the event-driven operation of automotive ECUs. A solution for this data bottleneck was required, ideally without the need of

**82527**  
Serial Communications Controller

**Product Overview**

The 82527 serial communications controller is a highly integrated device that performs serial communication according to the Controller Area Network (CAN) protocol. Specification 2.0. It is Intel's first device to support both the standard 11-bit and the extended 29-bit message identifier format.

The 82527 controller is a joint development of ROBERT BOSCH GmbH and the Intel Corporation.

**Product Highlights**

- Supports CAN Specification 2.0, both 11- and 29-bit message identifiers.

**Benefits**

- Compatibility with CAN Specification 2.0, a standard communications protocol.
- Reduced host-CPU overhead to manage bus communications.
- Up to 1 Mbit/sec transmission rate.
- Versatile host-CPU interface modes.
- Message objects can receive multiple message identifiers using acceptance masks.

**Packaging**

- 44 Lead Plastic Leaded Chip Carrier (PLCC)
- Automotive grade: -40 to +125 degrees Celsius.

*The 82527 is a full function CAN device offering the implementation of 29-bit message identifiers, 15 message objects and six flexible CPU interface modes.*

Figure 6: Intel 82527 advertisement (Photo: Bosch)

a radical transformation of automotive networking. For that reason, Bosch upgraded the CAN protocol to CAN FD.

CAN FD was first published in a white paper in April 2011, soon followed by hardware demonstrators. It increases CAN's data rate in two ways: First by switching to a higher bit-rate for the payload of a CAN frame and second by extending the frame's data field to improve the header/payload ratio. The maximum data length in CAN FD is 64 bytes. The rest of the Classical CAN features, like arbitration, acknowledge, and error handling, are left unchanged. There is no disruptive transition when switching from CAN to CAN FD; the design environment and hardware can be upgraded incrementally. CAN FD nodes are still able to take part in Classical CAN network communication.

The physical layer and bus topology of Classical CAN may be left unchanged when the network is upgraded to CAN FD; the signal delay times that limit the Classical CAN's bit-rate are not relevant for the bit-rate in CAN FD's data phase. This bit-rate is still limited by transceiver asymmetry and by ringing on the bus line. The advantages of CAN FD have been accepted in the CAN community, so several CAN controller ICs are available today, as well as design and measurement tools. Standardization started early and culminated in the integration of the CAN FD frame format in ISO 11898-1:2015. The physical layer standardization in ISO 11898-2 also considers CAN FD, e.g. by new parameters for bit symmetry. Transceivers released for CAN FD are already in production. Volume production of the first cars using CAN FD is expected to ramp up in 2017.

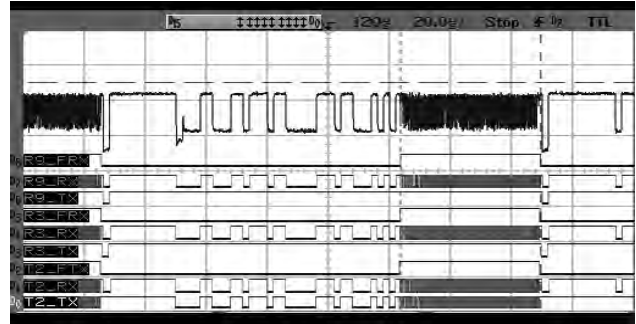

Figure 7: CAN FD frame (Photo: Bosch)

For industrial automation, CiA's working groups upgrade the CANopen software standards to integrate CAN FD. Other standards (CiA 601) provide guidelines for hardware integration. New security concepts for CAN networks have also been developed, enabled by the longer data fields of CAN FD that allow adding a signature for message authentication.



Author

Florian Hartwich  
Robert Bosch  
[florian.hartwich@de.bosch.com](mailto:florian.hartwich@de.bosch.com)  
[www.bosch.com](http://www.bosch.com)



Visualize  
with safety!



**interACT-VSX-Series**  
Display Family

- Variants from 7 to 15 inches
- SIL2-qualified hardware and software platform
- Extendable through expansion boards
- High viewing angle
- Graphical design and programming tool

Exhibition Dates



**Hannover Messe Industrial  
Automation**, Hanover  
24.04. – 28.04.2017



**Sensor + Test**,  
Nuremberg  
30.05. – 01.06.2017

# From 1992 to 2017: CiA's 25<sup>th</sup> anniversary

*Yes, 25 years is a long time in electronic business. Compared to the lifetime of some equipment used in rail vehicles, maritime electronics, or lift control systems it is not that long. And CiA still has things to do.*



(Photo: CAN in Automation)

Consortia with dedicated topics have a limited lifetime. They are established for dedicated tasks such as developing specifications or organizing marketing events. CAN in Automation (CiA) was established 25 years ago to introduce the Controller Area Network (CAN) protocol to different markets, and to release additional technical specifications to achieve compatibility and interoperability of CAN-based products. In the early days of CAN, the physical layer was not standardized at all. Some early birds used modified EIA-485 circuitry and any bit-timing settings. Of course, the products were not compatible at all. There was also no connector pin-assignment agreed, although most of the industrial users preferred the 9-pin D-sub connector.

This is why CiA members after the official establishment of the international users' and manufacturers' group at first specified some bit-timing settings (bit-rates and sample-point ranges) and the pin-assignment for the above-mentioned connector. The first released document, was the CiA 102 recommendation for industrial CAN interfaces. Harald Eisele prepared it, in those days he was working with Philips Semiconductors. The document contained the pin-assignment for 9-pin D-sub connector, which was accepted over the years by nearly all CAN users worldwide. In the meantime, CiA has recommended more pin-assignments for many different connectors (see CiA 303-1). Of course, for dedicated applications, other associations have standardized the pin-assignment for further connectors.

From the beginning, CiA members demonstrated the compatibility of their products. Already after half a year, about 20 companies participated in the first CiA joint booth at the Interkama tradeshow in Duesseldorf (Germany) in

autumn 1992. By the way, this fair for process automation has closed its doors forever. In the following years, CiA organized joint stands at the Hanover Fair with a lot of participating members.

## Committed to international standardization

Nonprofit associations are organized differently: There are consortia with company membership (e.g. VDMA, ZVEI), while others are made by memberships of individuals (e.g. SAE, IEEE, VDI). In the beginning, CiA allowed both kinds of memberships. But when some big enterprises joined CiA by means of individuals such as students and single engineers, the membership for individuals was skipped.

And there are the official standardization bodies such as IEC and ISO and its European counterparts Cenelec resp. CEN – not to forget the national standardization bodies such as Afnor, Ansi, BSA, and DIN. From the beginning, CiA was committed to cooperate as close as possible with those bodies. Nowadays, CiA staff participates in or observes nearly any international working group, which deals with CAN technology.

As mentioned above, CiA members wanted to achieve compatibility of CAN products. It is obvious that with a not matching connector you cannot provide any compatibility. The same is true, if you use different bit-rates. But what is about the usage of the CAN data link layer? In the early days of CAN, most of the users kept the content of CAN message as a secret including the usage of the identifiers. Nevertheless, CiA members started to discuss the standardization of an application layer. Driven by Tom Sutera from Philips Medical Systems and Prof. Dr. Konrad Etschberger from STZP (a German technology transfer center), ▷

CiA started to develop the CAN Application Layer (CiA 200 series). The outcome was a very academic approach. The first implementations required a lot of resources in computing power and memory.

Bosch and another technology transfer center proposed to simplify CiA's CAN Application Layer. This was the birth of one of the most successful communication systems: CANopen. It was pre-developed within a European research project. Engineers from Bosch, Moog, STA Reutlingen, and many other parties (e.g. Baldor, Selectron, Tetrapak) contributed to the first CANopen specifications. In 1994, CiA took over the results from the research project. Nowadays, the CANopen specifications and recommendations comprise more than 20 000 pages.

In the beginning and mid of 90ties also other nonprofit associations dealt with CAN-based application layers. SAE invented the J1939 application profile and ODVA specified Devicenet. In addition, some industries accepted proprietary application layers as de-facto standards: CCP (CAN Calibration Protocol) and SDS (Smart Distribution System) by Honeywell. CiA was not directly involved in these activities.

### Focus on CANopen profiles

In the following years CiA members developed many CANopen profiles. Starting with the profile for I/Os (CiA 401) and electrical drives (CiA 402) the number of CANopen device profiles has been increased continuously and still

is. End of last year, CiA members started to standardize a profile for IO-Link sub-networks. The only international standardized profile is CiA 402 (IEC 61800-7-201/301).

Besides the device profile approach, CiA members developed CANopen application profiles. These are system design approaches such as J1939. The very first one was the CiA 407 profile for passenger information systems, in the meantime published as EN TR 13149 series. Other application profiles include CiA 417 for lift control, CiA 422 for refuse collecting vehicles (also published as EN TR 16815), CiA 443 for subsea trees (also partly published in ISO 13628 series) just to name a few. The CiA 447 application profile for special-purpose cars has failed to be accepted as ISO new work item. Nevertheless, it has been accepted by several police administrations as de-facto standard. CiA will even provide a conformance test service for CiA 447 products.

Device and application profiles standardize the process data, configuration parameters, and diagnostics information. Standardized profiles improve the interoperability of devices. This is what system designers need – in particular for small and medium volume applications. Of course, in the breast of suppliers there may dwell a second soul: Making the customers depending on their products.

Of course, most of the CiA members are just interested to get access to the specifications. Some of them also like to observe the standardization process. If necessary, they even send some comments. The number of members active in CiA's technical groups has unfortunately decreased over ▶



Measurably  
safer!



# STW

**digisENS-F02**  
Safety pressure transmitter

- For safety related applications
- PLd/SIL2 Certified
- With ratiometric outputs
- Built for rough environments
- Shock, vibration and temperature resistant
- E1 approval for road use

#### Exhibition Dates



**Hannover Messe Industrial  
Automation, Hanover**  
24.04. – 28.04.2017



**Sensor + Test,**  
Nuremberg  
30.05. – 01.06.2017



CiA's Board of Directors					
1993	Holger Zeltwanger		Tom Suters (Philips Medical)	STD*	Gerd Waizmann (On Time Eng.)
1994			Nick Ray (Interay)		Harald Eisele (Philips Semicond.)
1995			John Doran (Moog)		Prof. Dr. Konrad Etschberger (STZP)
1996			Stefan Wagner (TU Braunschweig)		Douglas Norris (Honeywell)
1997	Christoph Duwe (esd)	Technical Director	Stefan Wagner (TU Braunschweig)	Managing Director	Holger Zeltwanger
1998			Guido Beckmann (TU Braunschweig)		
1999			Viktor Schiffer (Rockwell)		
2000			Christian Schlegel (Ixxat)		
2001					
2002					
2003					
2004	Arnulf Lockmann (JanzTec)		Heinz-Jürgen Oertel (Port)		
2005					
2006					
2007					
2008					
2009	Harm-Peter Krause (esd)		Uwe Koppe (MicroControl)		
2010					
2011					
2012					
2013					
2014					
2015					
2016					

\* Special Tasks Director

the years. To maintain documents is not so fancy than to develop them from the scratch. The days of the pioneers are gone.

No, this is not 100 % true: When we started to develop CAN FD, most of the chipmakers were active in CiA's working groups developing additional recommendations and guidelines for the proper usage of CAN FD (CiA 601 series). This work is not yet finished and now needs also expertise from the different industries. CANopen and J1939 on CAN FD (CiA 602 series) are just two examples, in which additional specifications need to be developed. CiA staff also supports other CAN FD adaptations (e.g. by Arinc for usage in aircrafts).

### There is more than just standardizing

To standardize physical layers and application layers as well as profiles is just one side of the coin. The other side is the marketing of technology. From the beginning, CiA office organized seminars, workshops, and conferences to educate and promote CAN technology. Very important is the international CAN Conference (iCC). The first took place already in 1994. Of course, the presented papers are

important and these events are sometimes used to introduce new protocols such as CAN FD, but more important are the discussions during the breaks and in the evening's events. The iCC is the social networking event for the CAN community. In addition, the papers published in the proceedings are a source of prior art publications avoiding that somebody can patent something what is already common knowledge.

Another important tool to distribute information are CiA's publications, especially the CAN Newsletter published since June 1992. Of course, it has changed from a hand-copied newsletter to a professional magazine. A couple of years ago, it was divided into an online magazine ([CAN Newsletter Online](#)) with product-oriented news and reports as well as a PDF-formatted magazine with technical articles, application stories, and background information.

### The future of CiA

Even after 25 years since its establishment, the CiA organization has a lot on its to-do list. Besides some additional CAN FD general recommendations and

guidelines, dedicated CANopen FD specifications need to be developed. Further information events such as "CAN 2020" are necessary to spread the CAN FD/CANopen FD knowledge into each remote corner of the CAN community. Therefore, CiA will schedule several CAN 2020 webinars in 2017.

Most important is that new faces will support CiA activities. There were a huge number of contributors in the past. Some of the most active ones are retired or going to be retired, and some of them passed already away, many of them too early. Fortunately, in the last years, new active members appeared. Just to name a few in alphabetic order: Dr. Tobias Islinger (Denso Automotive Deutschland), Magnus-Maria Hell (Infineon), Dr. Arthur Mutter (Bosch), and some more. Others, already active in CiA since many years, have increased their contributions: Uwe Koppe (Microcontrol), Dr. Martin Merkel (HMS), Olaf Pfeiffer (ESAcademy), and several others.

An association such as CiA is just as strong as the members contribute. CiA staff and the CiA Board of Directors are just managing what the members provide. It are the members and their representatives, who make the success. CiA with its about 600 member companies has limited resources to develop the markets and technology. Nevertheless, if they join their limited forces, they cannot just face the future challenges, but they can overcome them.

One of the challenges in industrial automation is the development of joint, bus-independent profiles. CiA is prepared and willing to submit its profiles not just for industrial automation, but also for other industries. Interoperability is one of the key issues to achieve consistency between devices from one end to the other end independent of used communication technologies. It is not sufficient to standardize containers. This is true for Autosar as well as for Industry 4.0. ◀

**Author**



Holger Zeltwanger  
CAN in Automation e. V.  
[headquarters@can-cia.org](mailto:headquarters@can-cia.org)  
[www.can-cia.org](http://www.can-cia.org)

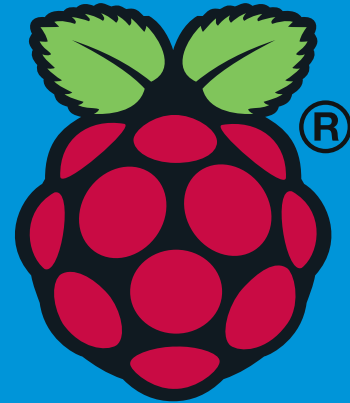
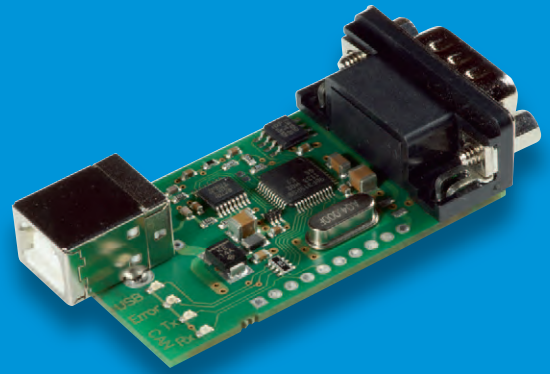

# Raspberry Pi



**OPEN SOURCE**

**DOWNLOAD**

[http://github.com/  
MHS-Elektronik/J1939Display](http://github.com/MHS-Elektronik/J1939Display)



**MHS Elektronik**  
[www.mhs-elektronik.de](http://www.mhs-elektronik.de)

# Back to the future

*This article is about a talented developer who uses the CAN relays module Keybox from Blink Marine to conduct a massive I/O extension in fully electric cars.*



Figure 1: The Mercedes Benz with Keybox from Blink Marine (Photo: Blink Marine)

Blink Marine sat down with Collin Kidder, a CAN protocol hacker and early adopter of the company's CAN relay module Keybox. Together with his staff at [K & K Manufacturing](#), Kidder has used Keybox for a project for the full electric conversion of a historical automobile: the 1959 Mercedes Benz 190SL. Thanks to Keybox and the Powerkey PRO 2600 keypad from Blink Marine, Kidder was able to significantly extend the car's capabilities. Now, in addition to a fully electric 47 kW engine, the car can boast evolved instrumentation including cruise control and a six-key CAN keypad.

The vehicle control unit uses an ARM Cortex M3 processor that has built-in CAN. It is very helpful to use a processor where the CAN controller is integrated. This allows for a fast reception and sending of CAN frames without having to deal with external signaling to a controller. The SAM3X used in GEVCU (later more) has a fairly nice CAN controller with eight mailboxes and fully interrupt driven.

Kidder writes software/firmware for electric vehicles and reverses engineer existing OEM components so that they can be used in aftermarket conversions. For instance, the Mercedes project uses a UQM motor and inverter from a Coda car. The Coda company went bankrupt, but left behind a large stock of motors and inverters meant specifically for that car. He figured out how to produce the proper security responses and helped to write a code to control the inverter. He has also gotten into doing the actual electric vehicle conversions.

Before he discovered Blink Marine, Mr. Kidder's project he was working on was a 1959 190SL Mercedes Benz that was converted to all electric. He needed a good way to control things like lights and contactors. Since the car is an antique, it was very, very, basic in terms of electrical connections. They just didn't have much of anything powered back then, certainly not 500 A contactors or pre-charge resistors.

To accomplish his goal, Kidder used the Blink Marine Keybox to add control to systems that didn't exist in the 1950's. Keybox helped him to add things to the car that the car wasn't designed for, like:

- ◆ LED turn signals with configurable blink duration and emergency (four way) flashing lights
- ◆ Control of a main contactor
- ◆ Control of the pre-charge resistor contactor

"I could have done some of the things I needed to do with my existing hardware, but I was running out of I/O on the ECU. The Keybox really helped by giving me a lot of extra outputs that I could easily control over CAN. As a bonus, the Keybox is also quite small and well-contained so it allowed me to pack a lot of outputs into a small space", said Kidder. He also used the Powerkey PRO 2600 pad. This allowed him to add even more things that the car would never have had otherwise. He added cruise control to a 1959 car. The keys were also used for shifting (the car was originally a stick shift and he removed the



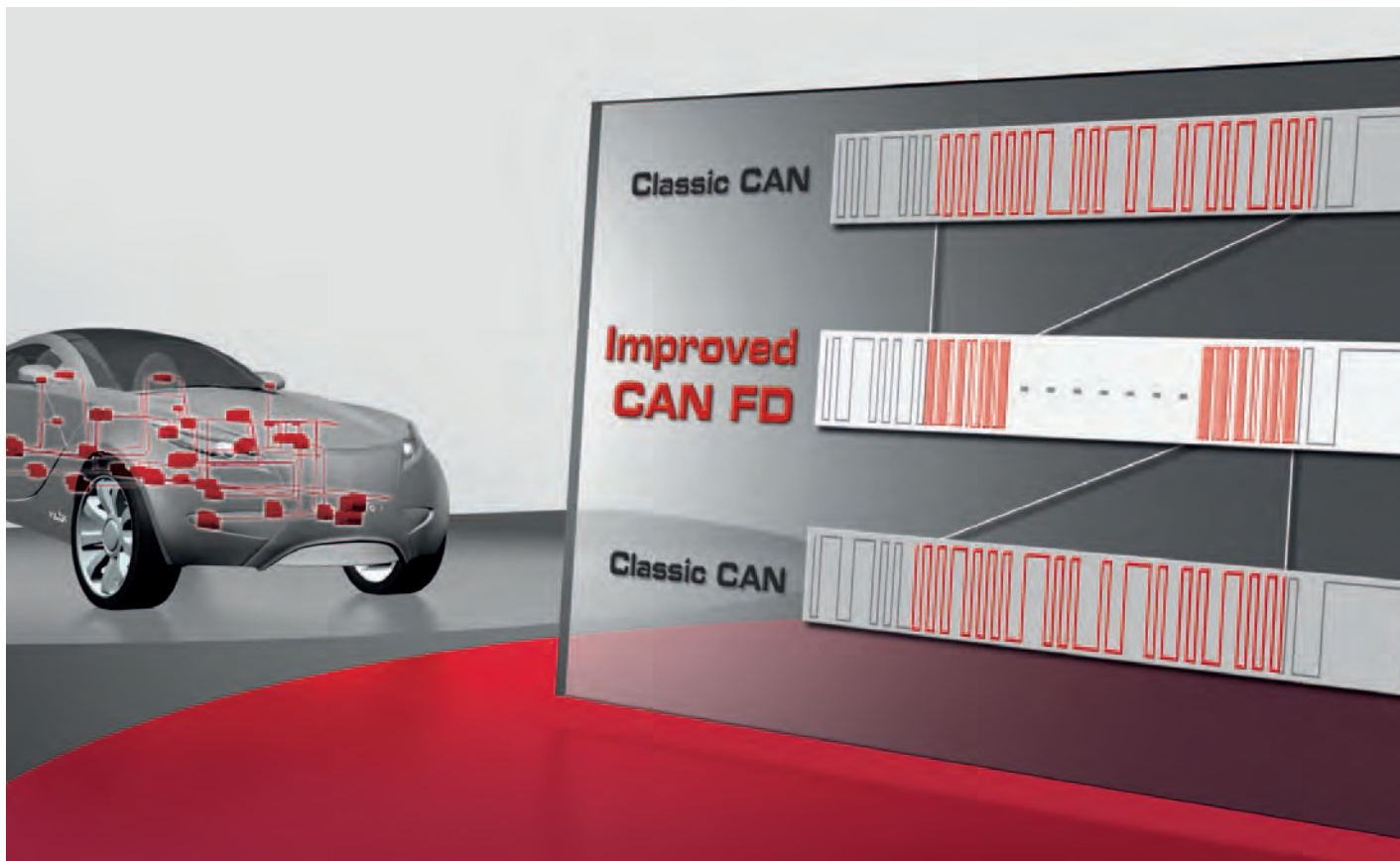

## First class solutions for your CAN and CAN FD based projects

### Your complete and universal tool chain

Increase the efficiency of your projects with the use of the complete tool chain from Vector:

- > Tools for testing, flashing and calibrating ECUs
- > Flexible bus network interfaces
- > High performance Scope for bit accurate signal analysis
- > Easy to configure AUTOSAR basic software
- > Worldwide engineering services and trainings

Information and downloads: [www.can-solutions.com](http://www.can-solutions.com)

**More CAN power by Vector: benefit from over 25 years of networking experience.**

**Congratulations on  
25 years CAN in Automation**



Figure 2: The keypad configuration (Photo: Blink Marine)

transmission), to trigger emergency four way lights, and to be able to manually force the cooling fans on. “The Blink Marine button faces are much nicer and more numerous than other company's button faces, so we were able to find a set of self explanatory button faces that look really nice”, he added.

The Mercedes Benz kind of reminds of the cars in “steam punk” literature. But why did Kidder start working specifically on this type of car? What inspired him? According to him, his main business – where he works most of the time – involves making body and frame parts for antique Mercedes Benz and Porsche cars. So he is really familiar with Mercedes Benz. “Some of the people here have restored more than 30 190SL cars. You could say we're experts in 190SL restoration. Our close ties to antique Mercedes brought us to the attention of a customer who wanted to do a 190SL electric conversion and had purchased parts to do so. But he was having trouble getting the project done. We talked him into sending us the car and we finished it for him. It was the very first electric car we'd ever touched. This was with lead/acid batteries. The car worked, but the lead batteries were so heavy that they affected performance. So, we got the car back and switched to Lifepo4 batteries. That increased performance and the customer was happy for years. But then, over time electric car technology continued to improve. I had gotten the UQM inverter to work and the customer was looking for more power. The UQM fit the bill, and the batteries in the car were starting to suffer a bit anyway (a few bad cells) so we took the car back, switched to the UQM motor, removed the transmission, and added Blink Marine's Keybox and Powerkey Pro. This final conversion really did take it in a steam punk direction. Now it is a 1959 car with custom body work, a very powerful motor, and LED push button controls on the dash. It's a very interesting mix of antique and modern”, Collin explained.

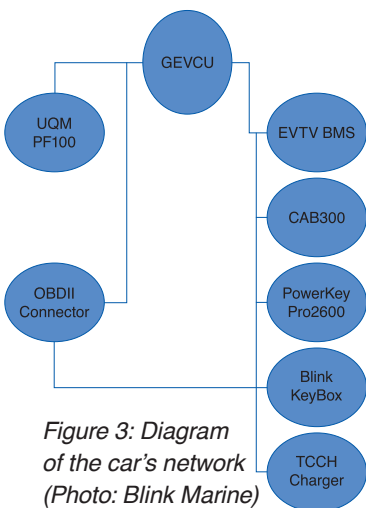

Figure 3: Diagram of the car's network (Photo: Blink Marine)

### GEVCU

The GEVCU (Generalized Electric Vehicle Control Unit) is an intermediary control device for electric cars which basically allows to transform various input signals like throttle pedal position or brake pressure to be transformed into control commands for electric motor controllers (aka inverters). The control

commands are sent via CAN messages or digital / PWM signals to the motor controller to spin the electric motor. It consists of open source software and hardware. The hardware is based on Arduino Due technology but was hardened for use in automotive environments. The software is designed in a way that new motor controllers, input and output devices can be added to the existing solution and everybody is free to extend the existing solution.

Collin Kidder is also involved in the [GEVCU project](#). He wrote most of it. It was originally conceived by Jack Rickard of [EVTV](#) as a way to have a universal system that could bridge the gap between various OEM components installed in a custom car. The problem was that the Leaf DC/DC converter wasn't meant to work in a car equipped with a UQM inverter, a Coda charger, and a Blink Marine keypad. It needed something in between all these systems; something that could provide each one the custom messages it needs to make everything work harmoniously in the custom vehicle. GEVCU was developed as the solution to that problem. Jack Rickard produced a design document and a few people got to work making it happen. Kidder is the main developer for the firmware, but other people wrote some of the code as well.

GEVCU has a set of eight outputs but they're all low side drivers. This has worked fine for many people, but sometimes it's nice to be able to switch high side as well. When going to high side there's the question of "which voltage?" or "which signal?" It's difficult to satisfy all possibilities. The Keybox from Blink Marine leaves the choice up to the user. Each output has two wires, and the end user decides what to connect. Kidder used this capability to do some high side and some low side switching with the Keybox. Also, he ended up with far more than eight necessary outputs, so he had to



Figure 4: Mercedes Benz and its new features (Photo: Blink Marine)

Tektronix®

# Drive to CAN FD faster

Capture more data with  
Tektronix Oscilloscopes

LEARN MORE AND  
REQUEST A DEMO AT:  
[www.tek.com/CANFD](http://www.tek.com/CANFD)

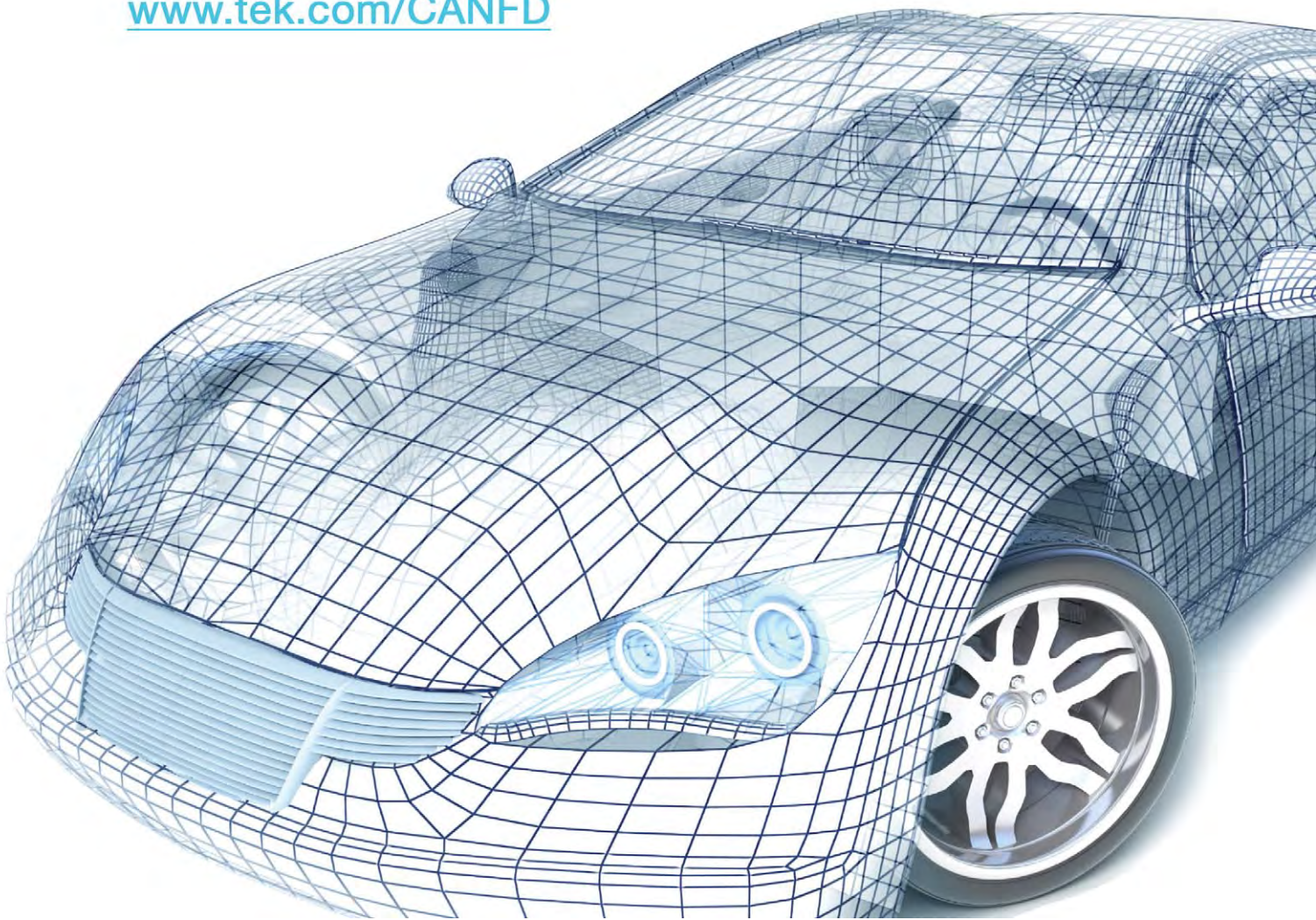

## Collin Kidder

- ◆ Skilled developer
- ◆ CAN protocol hacker
- ◆ Geek
- ◆ Gaming enthusiast



Active in embedded development, Collin has designed both the hardware and software for a biometric safe and a wireless vehicle access control project. He helped design hardware for a vehicle control system, and is currently leading a project to develop open source software for a vehicle control module.

integrated. I continue to work on GEVCU improvements and reverse engineer other OEM electric vehicle components. I'm also working to make or find a reasonably priced [Chademo](#) station so that I can install more of them in the US. We've got a lot of Chademo stations in the US, but it's a very big country and coverage is not good. For example, there are no stations within 200 km of where I live. This puts all existing chargers too far away. I'd like to fix that. Also, I have plans to help produce a system that makes it possible to add Chademo to electric vehicles that don't have it. Some testing is already underway for that..", he finished. ◀

overcome GEVCU's limits anyway. The Keybox was a valuable addition both because he needed more outputs and because it is so configurable.

Most of the communications were custom messages on plain CAN. However, the Keybox and Powerkey use CANopen. Many hobbyist grade devices for DIY (Do It Yourself) electric cars just use plain CAN with custom message formats. This lack of standardization is partly why a VCU like GEVCU needs to exist - to translate and interpret messages in all of the custom formats so that all of the devices can work together. GEVCU does support the OBDII CAN standard (ISO 15765-4, PID codes). GEVCU uses an isolated transceiver: ISO 1050. This chip gives isolation between the CAN wiring and the board power and signal lines. Sometimes things get pretty electrically noisy in a car and an isolated transceiver seems to be the way to go. Everything in the car was 500 kbit/s. This allowed for fast communication without difficulties.

Since the car was from the 1950's which was many decades before CAN even existed, Collin added many CAN connected devices to the car. GEVCU coordinates with them all. The HV battery charger is CAN controlled. There is a BMS monitoring the cells which allows GEVCU to make decisions about how to best control the battery charger. A CAB300 current sensor is also connected via CAN and is used by the BMS to measure state of charge for the pack. There is a 12-key Powerkey Pro on the dash which is CAN connected and is used for gear selection, cruise control, hazard lights, regen settings, and fan control. Additionally, a Blink Marine Keybox was used for most of the car's 12-V switching needs. This controls such things as the LED turn signals, fans, pre-charging, main contactor control, and brake lights when doing heavy regen. The car uses a UQM Power Phase 100 motor and controller as well. GEVCU controls the inverter through CAN messaging. In the car one CAN network has GEVCU, the UQM inverter, and the OBDII plug on it. A second CAN network has everything else (with also the OBDII plug). In this way either network can be monitored from the OBDII plug for diagnostics.

## What the future holds

Right now Collin is working on a somewhat secret car project he can't really tell anything about. "I'll be working on one or two more cars in the near future. I think all of them will use the same basic products now that I've got them all

## Author



Eliseo Boldrin  
Blink Marine  
[eliseo.boldrin@gmail.com](mailto:eliseo.boldrin@gmail.com)  
[www.blinkmarine.com](http://www.blinkmarine.com)



## Highly Robust Operator Interfaces

### Usability

- Excellent sunlight readability
- Ability to display videos and PDF documents
- Programming and debugging facilitated by CODESYS® V3

### Performance

- Best-in-class CPU performance
- OpenGL graphics with hardware acceleration
- Fast boot-up time
- Sleep mode, wake-up pin and wake-up timer (<0,5s)

### Connectivity

- Optionally GPS and GSM enabled
- Two camera interfaces with picture-in-picture functionality
- Up to 4 CAN interfaces
- Interface for Ethernet cameras
- WLAN interface

HY-eVision<sup>2</sup> Family



[www.ttcontrol.com/HY-eVision2-Family](http://www.ttcontrol.com/HY-eVision2-Family)



Safety  
Certified  
ECUs



General  
Purpose  
ECUs



I/O  
Modules



Safe I/O  
Modules



Operator  
Interfaces

# Adventures of a CANopen consultant

*You may not expect the life of a CANopen consultant to be overly exciting. If so, our anonymous author will prove you wrong. From clueless clients to secret military applications, the world of CANopen offers unexpected challenges.*



I had my first real contact with CANopen in the year 2000. Our small embedded system consulting firm was just a few weeks old, we had some experience with CAN, and sure enough, a client found us: “I have this inherited Z80 assembly project here to which we need to add CAN RTR PDO communication, actually CANopen. I can provide a C compiler and provide you hooks from our own scheduler. Can you help us?” Today I know that there were multiple red flags in this request. Can you spot them all?

- ◆ “inherited project”: No one has a clue how this works.
- ◆ “assembly project”: You will never know what it really does.
- ◆ “RTR” (remote transmission request): Why do you use something that asks for trouble?
- ◆ “can provide”: Eventually (a day before the deadline), you might get something that vaguely does what you desperately needed to do your work.
- ◆ “own scheduler”: A long table with call instructions. If you add a call, it might get executed at any time and screw up all timing behavior for sure.

What can I say, we were young and needed the money and we were still adventurous: we took the job. We helped the client select a commercial CANopen source code, configured it, and built a library to include to the assembly project. Despite all the red flag issues we got it working eventually and by the time we did, we were true CANopen experts: any and all traps that such a project can contain, we had found them all.

The RTR mode is something that even today still pops up once in a while. Due to a specification gap, chip manufacturers have implemented it differently – in a non-compatible way. That is why RTR was removed from the CANopen specifications and the CiA published a white paper more than ten years ago that asked implementers to stop using it. But you cannot kill a technology easily, which is why some Zombie devices still use it.

Nevertheless, when the next call came, we felt much more confident about our ability to handle it: “We have this commercial CANopen stack here and the performance on our 8-bit controller is horrible, can you have a look?” At that point, they had already spent a few weeks with technical ►

# Insert – Ready – Cloud Solution!

## Simply connect CANopen to the Cloud with our IoT Chip

- ⊞ plug-in computer core for a direct cloud connection (IoT Chip)
- ⊞ freely programmable by users
- ⊞ combines sensor2cloud requirements with data preprocessing features ranging from time-critical signals to efficient control tasks
- ⊞ libraries and protocols such as CANopen, MQTT or Modbus pre-installed

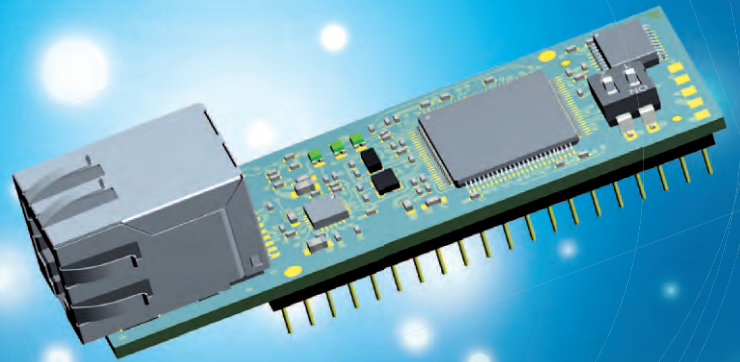

Test our IoT Chip at the  
“embedded world” trade fair  
from 14 to 16 March in Nuremberg.

support to narrow it down, but as there were several software providers involved, everyone simply blamed the other party. Once on-site (eight hours of travel and a flight to get there), it took not much more than half an hour to solve the problem. Somewhere “hidden” (just a few function calls away) in the timer interrupt, a display timer was maintained that used floating point arithmetic... on an 8-bit controller... running at some 20 MHz... This was a leftover from the CANopen stack demo. I had been contracted for a minimum of eight hours and I don’t really remember what I did during the remaining seven and half hours. Possibly this was the client where I always ended up in that nice Irish Pub just around the corner?

On the next day back at the office, we received a call from the CEO of the CANopen stack provider. My, he sounded upset. How could we go in there as external consultants and fix his code in only 30 minutes? What the --? Was he really complaining that we had not informed him first? We were contracted by his client to look at his code. Well, as a consultant you cannot satisfy everyone all the time; just make sure you keep the paying party happy. In the end, we have to be thankful because these early experiences with multiple commercial CANopen stacks encouraged us that in regards to 8-bit micro-controllers we can do better. That was the moment of birth of our own CANopen stack, optimized towards 8-bit systems.

However, when it comes to “shortest consulting job”, then the job mentioned above was topped later on. We received a call that said: “You have been recommended to us. Our CAN communication does not work at all, can you come in here and help?” In the CAN technical support world, the first thing you learn is to verify all physical settings first: cabling, termination resistors, and bit-rate. The client assured us that all of this had been checked over and over. Again, it involved multiple hours of traveling and a minimum of eight hours of consulting for us to go on the journey. It was a military application and for me to get access, some of the equipment had to be covered in linen, so that I could not see it. I felt more like being in some old attic than in a lab. Well, they gave me access to the CAN cable and what did I do first? I checked the multimeter. Do I need to say more? The termination resistance was about half of the expected 60 Ω, which is what you get with two termination resistors. Those were my best-paid ten minutes as a consultant ever: plugging in a missing termination resistor.

Speaking of military applications: those can be really strange. I once made it to the lobby of a major US military supplier and was asked: “What is your clearance level?” My answer was: „Well, I am German and not aware that I have any“. So the engineering team came out, joined me in the lobby, and for about an hour we discussed hypothetical

CAN issues in the lobby. But in regards to technical support, military customers can be great. We really had a conversation along the following lines:

- ◆ Client calls in: “My CANopen communication based on your stack does not work.”
- ◆ Support: “How have you configured it?”
- ◆ Client: “I can not tell you, that is a secret.”
- ◆ Support: “Weeeeell, are you seeing any CAN messages on the bus?”
- ◆ Client: “Yes.”
- ◆ Support: “So which messages are you seeing?”
- ◆ Client: “I cannot tell you, that is a secret.”
- ◆ Support: “Oookay, what can you tell me about your CANopen communication?”
- ◆ Client: “It does not work.”

Typically that about ends the conversation and you never hear from them again. Over the years, the “weird” clients and applications have become less, but possibly they simply do not pass the red flag filter we have now: if a first-time customer request raises more than one red flag, we now leave it to the competitors to call them back first.

Interestingly, the decisions you have to make as a CANopen consultant can also involve the dark side, and I am not talking about the marketing department here, but something even darker. Years after we completed a project for a client, their legal department contacted us. They were in a US patent fight with a competitor and were in need of CAN and CANopen experts. It was unbelievable: the amounts that had been made available for the consultancy by far exceeded our usual rates. For this case, it would have been a multiple of the total engineering rate we ever charged to that company. We were tempted for a few (micro)seconds to take the money – but as an engineer; going into legal patent battles; in support of the side with the patent; potentially facing the CiA and Holger on the opposing side? Nahh... ◀

#### Author

Anonymous

Confidential



ifm electronic



# Look what we have for you!

An absolute must-have!

*ecomatmobile BasicController<sup>relay</sup>*: modular mini controller with powerful relay outputs with diagnostic capabilities for mobile applications. Direct connection of sensors and actuators without further external wiring, powerful CAN interfaces, programmable to IEC 61131-3 with CODESYS. Can be extended with other components, such as the BasicDisplay. With E1 type approval of course.



[www.ifm.com/gb/ecomatmobile\\_basic](http://www.ifm.com/gb/ecomatmobile_basic)

Phone: +49 0800 16 16 16 4

# Service robots: Modular and battery-powered

*Service robots are not yet produced in high volumes. It is still a research domain for university and institutes. Nevertheless, the first modules are under development for commercial service robots.*



(Photo: Commonplace Robotics)

The number of service robot applications is countless. They range from high volume applications such as robot vacuum cleaners and robotic lawn mower via service robots used in hospitals to distribute medicine to single service robot prototypes as prison guard in Korea. Most of the advanced developments take place in Far East. China, Japan, and Korea are the countries with the most research projects in this business. Of course, military service robots such as drones are not considered. In 2014, more than 25 000 service robots have been sold worldwide. The annual increase is about 10 %.

But there are not just robots serving human beings: In 2014, also about 5 000 milking robots were sold. In addition, about 6 000 so-called field robots for farming purposes were produced. Medical robots are also not booming yet. The only high-volume service robot markets are those robots for personal and domestic use mentioned above including toy robots. Some sources counted 4,7 million units in 2014. Disabled assistance robotics have not really taken-off (about 4 500 in 2014).

The market for service robots will increase. Between 2015 and 2018, there will be sold about 150 000 service robots according to the IFR (International Federation of Robotics) statistical department. The market for robots for personal use will increase to 35 million units, but they are not modularized and equipped yet with embedded CAN networks. Although, some of them may use some CAN point-to-point links internally.

A growing sector is mobile platforms in general use. Service robot suppliers estimate that about 16 000 mobile platforms as customizable multi-purpose platforms use will be sold in the period 2015 to 2018. Also, sales of logistic systems will increase considerably in this period. More than 14 500 units are estimated, thereof, about 13 300 automated guided vehicles. About 700 robots for rescue and security applications will be sold between 2015 and 2018 mainly surveillance and security robots. Robots for professional cleaning will increase to about 6 650 units in the same period, mainly systems for floor cleaning. About 7 800 medical robots will be sold plus 4 000 robots for inspection and maintenance. ▶

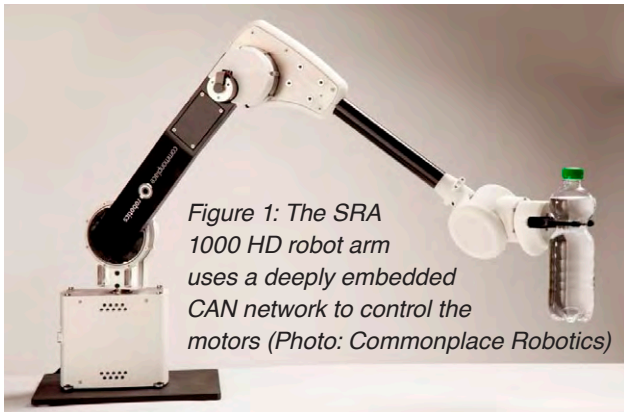

Figure 1: The SRA 1000 HD robot arm uses a deeply embedded CAN network to control the motors (Photo: Commonplace Robotics)



Figure 2: (Photo: Commonplace Robotics)

Collaborative robots as they are under development for the factory floor may change the situation. Even if they are not regarded as service robots, they have the same functional elements and safety requirements. They collaborate with human beings. They are not caged. They require some modularity to be adapted easily to different applications. They are battery-powered.

### Modular robots require standardized interfaces

Many service robots are battery-powered. Each gram counts. This means the service robots should be made of light-weighted modules. This applies also for electronic modules. In some applications, size matters, too. CAN

is an ideal network technology for service robots. CAN hardware has a small footprint, consumes not too much power, is reasonable in price, and robustness as well as reliability is high.

The CAN Newsletter has reported already about several service robots using embedded CAN networks. Several CiA members have supplied CANopen-based motion controllers such as Elmo, Faulhaber, and Maxon. Sensors to observe the surroundings have been applied by Sick, for example.

In the modularization of service robot electronics, ROS (robot operating systems) plays an important role. The `ros_canopen` package provides support for CANopen devices in a ROS programming environment. It contains the ROS interface, profile-specific support for CiA 402, a ▶

# Sontheim

Your reliable partner for innovative CAN systems

From design over implementation to testing

1996

20 YEARS

- ▶ Mobile or stationary CAN Interfaces in various form factors with WLAN, Bluetooth, Ethernet, USB and more
- ▶ Robust CAN Gateways and Data Logger with up to 256GB of built-in NAND-Flash-Memory
- ▶ Rugged ECUs for controlling, telemetry services and diagnostic application
- ▶ Monitoring and analyzing - our modular software tools for efficient fieldbus diagnostics
- ▶ Searching for a modular diagnostic tool based on standards? Have a look on our MDT! <http://www.sontheim-industrie-elektronik.de/en/products/automotive/diagnostics-tools/>

Embedded World 17, Nuremberg  
14.03 - 16.03.2017  
Hall 1, Booth 581

Sontheim Overview and Portfolio:

Automotive	Automation	Diagnostics	Software-Development	Hardware-Development

**We live electronics!**  
[www.sontheim-industrie-elektronik.de](http://www.sontheim-industrie-elektronik.de)

**DE Sontheim Industrie Elektronik GmbH**  
Georg-Krug-Str. 2, 87437 Kempten  
Tel: +49 831 57 59 00 -0 - Fax: -73  
info@s-i-e.de

**US Sontheim Industrial Electronics Inc.**  
One West Court Square, Suite 750  
Decatur, GA 30030  
Phone: +1 (404) 494 -7839 - Fax: -7701

CANopen NMT master function with device/object management, and a CAN layer abstraction. However, the ROS approach doesn't specify any service robot module.

## Hierarchical module approach

Some Far East countries with the support from a few European countries have submitted a New Work Item Proposal on the modularization of service robots (ISO TC 299). The proposal is not limited to electronic communication interfaces, there are also mechanical and electrical elements included. The proposal distinguishes between software and hardware modules, which is mainly an implementation issue and not a functional criteria to identify the purposes of a module. Unfortunately, there is no hierarchy of modules specified. This means, high-level (complex) modules such as a motion unit and a mid-level module such as a wheel controller are mixed with single-device modules such as a CiA 402 motion controller.

### Medical surgery robots

In healthcare, one of the most interesting applications are robot assisted surgery and therapy with about 1000 units sold in the last year. They are the most valuable service robots with an average unit price of about one million US-\$, including accessories and services. Therefore, suppliers of medical robots also provide leasing contracts for their robots.

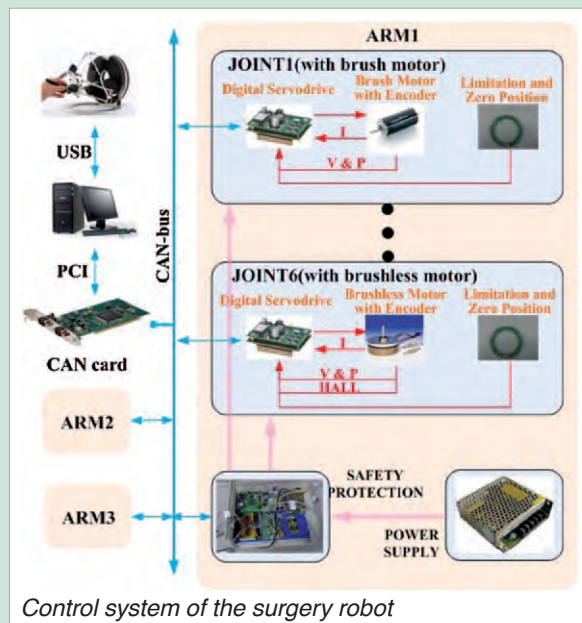

In some of these medical surgery robots, CAN-based control systems are used. For example in a robot, which comprises an optical navigation system, a workstation to run the 3D mandibular reconstruction surgery design software, and a main workstation to run the application and robot control. The robot task communicates with the robot via a CAN network and performs basic functions, such as receiving joint feedback. The control task implements the supervisory control layer. Its functions are to provide force and motion control. It also provides the interfaces to the force sensor and the navigation system.

What is necessary is a clear structured hierarchy of modules. Starting with high-level units. Those units comprise mid-level controllers, which by themselves are made by single-device units. This means, there are three levels of embedded networks. To make it simple, all of them are based on CANopen. Of course, depending on the application requirements, they can also use other communication technologies. CiA has developed originally such a virtual network for rail vehicles and construction machines. If powerful system design tools support this approach, it is very flexible and simplifies system integration. With CAN FD and its higher throughput capability, many of the embedded network requirements can be fulfilled. Service robots are not high-speed applications, because they have to interact with human beings, who are by definition slow. Nevertheless, safe operation is required.

Such a hierarchical module approach would allow reusing modules in different applications. Service robot prototypes are already used to serve in fast-food chains, while others experiment with room service robots in hotels. Both serve food and beverages. The surroundings are different and may require additional functionality. Still some functions are the same and can be solved using the same modules with the same communication interface. ISO should specify a framework (platform) and the application functions for such modules. CiA is willing to develop with interested parties related profiles with process data, configuration parameters, and diagnostic information. One of the first mid-level modules to be standardized could be a robot wheel controller.

The platform idea is not new. Most of the important carmakers have introduced them during the recent years. In Far East, in particular in Japan, the automotive industry sponsors (e.g. Nissan and Toyota) the service robot industry. Self-driving or in other words autonomously driving service robots require obstacle detection capability and collision avoiding functionality. These two topics are also hot in the car industry. Brain Corporation is one of the pioneers in this business. It develops the brains of self-driving vehicles including service robots. Self-driving vehicles include robotic floor care equipment. You could regard them also as service robots.

To develop such service robot module interfaces is something what requires joining the industries resources. The development of the self-driving algorithms is relevant for competition, but the communication interface is not. This is like in human communication, the common language needs to be "open", but the written text is property of the author.

#### Author



Holger Zeltwanger  
CAN Newsletter  
[headquarters@can-cia.org](mailto:headquarters@can-cia.org)  
[www.can-newsletter.org](http://www.can-newsletter.org)

FAULHABER Motion Control

# It's not a trick. It's engineering.

**NEW****WE CREATE MOTION****FAULHABER Motion Control Systems Series MCS 3242 / 3268 ... BX4**

It is hard to believe how much intelligent and high-performance drive technology we have conjured up in the compact FAULHABER Motion Control Systems. Their robust construction in accordance with IP 54 meets even the most severe industrial requirements. And, equipped with RS232, EtherCAT and CANopen interfaces, they secure future connections. Ready for networked industry? With FAULHABER, it's not a trick.

[www.faulhaber.com/mc/en](http://www.faulhaber.com/mc/en)Easy commissioning with  
the new Motion Manager 6

# Service robots with CAN-driven devices

*Manipulators and grippers, mobile bases, or sensors for service robots: CAN- and CANopen-driven devices enable the development of a variety of applications for service robots that are part of the private or professional field.*



*Figure 1: Paul, a member of the Care-O-bot 4 robot family, has been greeting customers in Saturn-Markt Ingolstadt since the end of October 2016 (Photo: Saturn)*

Service robotics is a booming industry. According to the statistics about this market, published by the International Federation of Robotics (IFR) and created in close cooperation with the Fraunhofer Institute for Manufacturing Engineering and Automation IPA, the total number of service robots sold for professional use increased in 2015 by 25 %. The sales value surged by 14 % to a new record of 4,6 billion USD. By 2019, sales forecast indicates another rapid increase up to an accumulated value of 23 billion US-\$. The main applications are robots for the domains medicine, field, logistics, and defense.

Not only have the professional sectors pushed the demand for new automated solutions. Also technologies for personal and domestic use like lawn mowers, vacuum cleaners, or robots for entertainment and education surged by 16 % in 2015 to a value of 2,2 billion US-\$. Between 2016 and 2019, the estimated sales will rise up to an accumulated value of 22 billion US-\$. The statistics are the result of a questionnaire that is annually sent out by the IFR to more than 300 companies. With a share of nearly 30 %, the number of startup companies is remarkably high and underlines the interest in the market. In total, Fraunhofer IPA monitors

more than 600 companies involved in service robotics all over the world and provides this knowledge to companies for strategic decision-making.

The success of the service robotics domain is due to a market pull and a technology push. The latter results in new and cheaper components like sensors, drive systems etc. Standardization is the key for interoperability and enables flexible and efficient solutions. CAN and CANopen in particular are well-suited technologies for building these systems. In the following paragraphs, an overview of possible use cases underlines their variability and the multitude of application areas.

## Ambient Assisted Living

Technical assistive systems enable people in need of help to be more independent, thus making them less reliant on others and sometimes even allowing them to manage entirely on their own. Under the heading of “Ambient Assisted Living” (AAL), various solutions have been developed in this field to help elderly people in their homes. The service robot Care-O-bot 3 was tested for several tasks in private home. It ▶



Figure 2: Care-O-bot fetching an object for its user  
(Photo: Fraunhofer IPA/Jens Kilian)

can, for example, do fetch and carry tasks. The manipulator and gripper are CAN-driven and enable the robot to grasp objects and deliver it to mobility-impaired users. This is a typical use case, as CAN needs only two additional wires and thus can be lead through the single modules. To place an order, the user can chose the desired object using e.g. a smart phone or the touch screen integrated in the tray of the robot. Care-O-bot is programmed to know where the different items are kept in the user's home. Using its navigation system, the robot is capable of independently finding the way to its target. After reaching its target, Care-O-bot autonomously locates the selected item, picks it up using its robotic arm and gripper and places it on its tray for trans-

port and safe transfer to the user.

Another application is entertainment and communication. The interactive touch screen of the robot can be used for all different entertainment and communication functions. Video telephony, for example, enables communication between the user and other family members and friends. The touch screen can also be used as game board, e.g. for interactive mind games or cognitive training. With help of three CiA 402-compliant actuators, the tray can present these communication interfaces to users in different everyday situations and sitting positions. Last but not least, the emergency support is an important use case for service robotics technologies in the field of AAL. The CANopen-driven mobile base of Care-O-bot enables it to patrol in home environments and to move towards a fallen person. At the same time, it can setup communication with an emergency center, who can talk to the user by video telephony using the screen, speakers, and microphone of the robot.



Figure 3: The "intelligent" care cart can be called by care staff and moves autonomously  
(Photo: Fraunhofer IPA)

# CiA

CAN in Automation

## Webinars

These web-based seminars provide an overview about the current status as well as trends in CAN-based networking. The webinars are all about the future of CAN FD and CANopen FD.

- ▶ **Session 1:** CAN FD protocol and physical layer design
- ▶ **Session 2:** CANopen FD - the art of embedded networking
- ▶ **Session 3:** CAN FD in future network architectures

For more details please contact CiA office at [events@can-cia.org](mailto:events@can-cia.org)

[www.can-cia.org](http://www.can-cia.org)



Figure 4: “Intelligent” dual-arm robot manipulation system to support the worker (Photo: Fraunhofer IPA/Rainer Bez)

## Healthcare

Although automation in the health care sector is not yet that common, first applications already entered the market. For example, robot-based rehabilitation systems for locomotion therapy might speed up the healing process through effective and intensified training. They can also help physiotherapists with physically-demanding tasks. To aid rehabilitation after a stroke or other illness where a patient has to learn to walk again, we developed a mobile therapy robot to stabilize patients during training. It features a number of CANopen-driven actuators that follow the person’s movements and even adapt the robot to the person’s height.

Besides medical devices, the health care sector has also a high potential for automation solutions in the field of logistics. In Germany alone, mobile robots and automated guided vehicles (AGVs) are used in more than 50 hospitals for the supply and disposal of everyday items such as patients’ meals, laundry, waste, and recyclables. So far, these vehicles operate in segregated areas (service floors/lifts) accessible only to trained personnel. Today, technological advances in the navigation of mobile robots make it possible for driverless transport systems to be used also in publicly accessible areas.

One of the goals of the collaborative project “Service Robotics for Support with Personal Services” (SeRoDi) sponsored by the German Ministry for Education and Research (BMBF) is to make use of this technology to develop an intelligent care cart to assist the care staff at care homes and hospitals. For technical realization of the care cart, a set of key requirements like autonomous navigation for on-demand supply and automated documentation of used care utensils were developed based on data collection surveys as well as on the currently used supply trolleys. Within the project, three units of the intelligent care cart are currently being prepared for user tests. They are backed by three CANopen-based omni-directional drives that enable the care cart to operate in crowded spaces.

## Retail shopping assistance

Changing the location completely and heading to the retail sector where the latest Care-O-bot development was presented last autumn (for more detailed information about Care-O-bot 4 and its use of CANopen and ROS please refer

to issue [1/2016 of the CAN Newsletter](#)). The charming helper “Paul” the robot has been greeting customers in Saturn-Markt Ingolstadt, Germany since October 2016 and directing them towards their desired products. The CANopen-driven mobile base allows free roaming in the retail market. Also the torso and head actuators are CANopen-driven so that “Paul” can offer user-friendly service including gestures such as nodding and shaking the head. This demonstrates the flexibility gained from the CiA 402 specification: The same driver commands 13 motors with different kinematics and drive modes.



Figure 5: The robot for automated testing processes can be taught by hand-guiding (Photo: Fraunhofer IPA/Rainer Bez)

## Further professional applications

The CANopen-driven mobile base is of even further usage. Another innovative application is the office-cleaning scenario. Within the project “AutoPnP”, a cleaning robot prototype was developed. It is capable of dividing a given floor map of its working environment into single rooms or units, visiting them, inspecting their ground floor for dirt spots, searching for waste bins and disposing them into a collection container in the robot’s tool trolley. After waste disposal, the robot can autonomously exchange its hand, which is used for handling waste bins, for a vacuum cleaner, which is stored in the trolley, and clean the found dirt spots. The gripper is CAN-based, the vacuum cleaner is driven by a CiA 401 compliant I/O module. For the exchange, first the tool changer is aligned very precisely via visual serving and then the attached device gets hot-plugged and identified.

Coming into the field of production, we developed a dual arm robot manipulation system for small part assembly tasks. The publicly funded “Prace” project aimed at developing this production assistance to fulfill the increasing demands for flexibility in production. To enable this, it is important that the robot moves in a similar way to its human counterpart and at the same speed. It can learn this by demonstration. Regarding this system, not only the mobile base is CANopen-driven but also the pan-tilt-unit. The latter is needed to keep the assembly parts in the camera focus.

## Autonomous testing

The last presented application is a system that does endurance testing of dishwashers. Conventionally, such tests have been highly time-consuming, with machines being operated manually one after the other in single-shift working. Fraunhofer IPA developed a robot for a well-known company producing household appliances to automate this testing. A combination of mobile chassis, manipulator, and ▶



sensors enables the robot to fully operate the machines: open the door, insert dirt, add the detergent, and press the start button. Working round the clock, it is safe and easy to teach while at the same time helping to standardize the test conditions. Besides the mobile base, also the linear axis is CANopen-driven and extends the motion range of the manipulator. This mobile robot system can be customized to allow companies to automate a variety of processes. Apart from different tasks in quality assurance, robots of this type can also be used for support with logistics and assembly or for inspection tasks.

For the usage of all the mentioned technologies and applications, we provide further information and engineering competences. Our institute is an independent technology partner suitable for all projects concerning the planning, conception, developing, and deployment of service robot technologies. Also, it is very engaged in managing the open source software community working on the Robot Operating System ROS. Fraunhofer IPA is leading the European branch of the ROS-Industrial consortium that targets industrial components and applications, including the CANopen driver framework `ros_canopen`. ◀

#### Author



Mathias Lüdtké  
Fraunhofer IPA  
[mathias.luedtke@ipa.fraunhofer.de](mailto:mathias.luedtke@ipa.fraunhofer.de)  
[www.ipa.fraunhofer.de](http://www.ipa.fraunhofer.de)

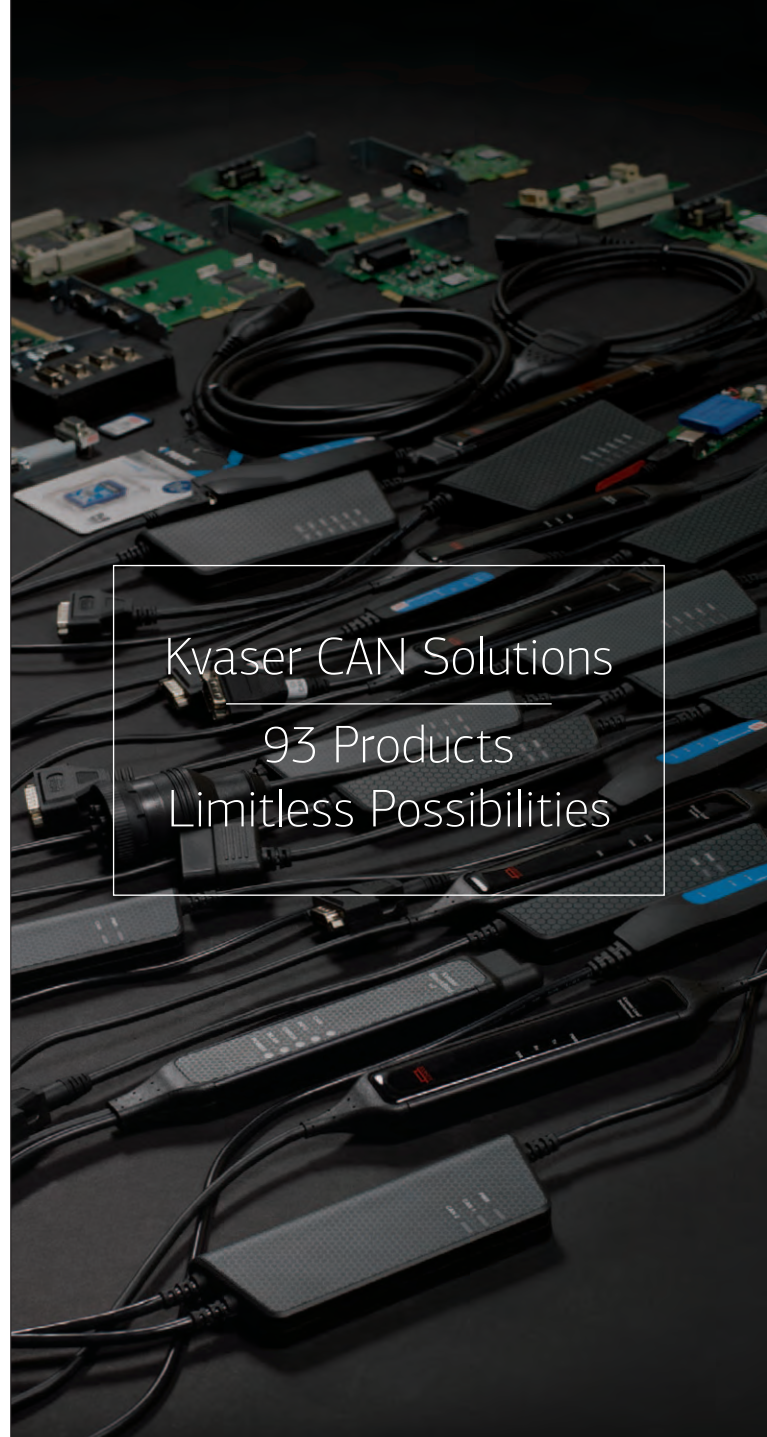

Kvaser CAN Solutions  
93 Products  
Limitless Possibilities

#### WHY CHOOSE A KVASER CAN INTERFACE?

*The Widest Range of CAN and CAN FD Interfaces and Dataloggers, Plus:*

- Free Support, Software and Software Updates for Life
- A Universal API
- An Open Ecosystem with Easy Toolchain Integration
- A Network of over 100 Software Partners and Qualified Sales Representatives



[www.kvaser.com](http://www.kvaser.com)

# Steppers versus servos

*Can the advantages of closed-loop servo technology be adapted to steppers? Could we realize the cost benefits of steppers while achieving servo-like performance?*

Technological advancements are changing the performance/cost ratio between stepper motors and servo motors for a growing variety of demanding industrial automation applications. Thanks to the adoption of the closed-loop technology, integration with drives, and the ability to operate in advanced CANopen networks, less expensive steppers are making inroads into applications that used to be considered the exclusive domain of the more expensive servos.

Conventional wisdom states that servo control systems are superior in applications requiring speeds greater than 800 revolutions per minute as well as applications that require a high dynamic response. Stepper motors are preferable in applications that run at lower speeds, produce low to medium acceleration rates, and/or require high holding torque. But where does this conventional wisdom concerning steppers and servos come from?

A stepper motor rotates in steps, using magnetic coils to pull a magnet from one position to the next. To move the motor a hundred positions in a given direction, the circuit steps the motor a hundred times. The stepper moves incrementally using pulses and can be precisely positioned without any feedback sensor. The servo's method of movement is different. It uses a magnetic rotor that is connected to a position sensor (an encoder), which continually senses the exact position of the motor. Servos monitor the difference between the motor's actual and commanded positions and adjust the current accordingly. This closed-loop system enables the motor to stay on course. Not only are steppers less expensive than servos, but they are also simpler to commission and maintain. At rest, steppers are stable and hold their position, even with dynamic loads. However, as the demands of certain applications increase, more expensive and complex servos must be applied.

A crucial difference between steppers and servos is in applications that require knowledge of the precise position of the machine at every moment. In an open-loop, stepper-controlled motion application, the control system assumes that the motor always moves correctly. However, when a problem is encountered, such as a jammed part that causes the motor to stall, the controller does not know the actual location of the machine, causing it to lose position. The servo's inherent closed-loop system holds an advantage: should the machine snag on an object, it is sensed immediately. The machine stops operating and never loses position.

Performance differences between steppers and servos derive from their dissimilar motor designs. Stepper

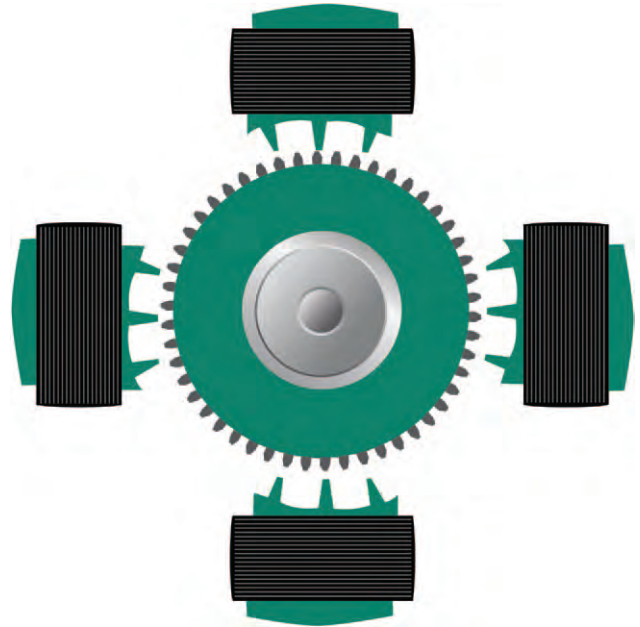

Figure 1: The mechanical structure of a hybrid stepping motor (Photo: Servotronix)

motors have a lot more poles than servo motors, thus one complete rotation of a stepper motor requires many more current exchanges through the windings, causing its torque to fall off dramatically as speed increases. Furthermore, steppers can lose their step synchronization if the maximum torque is exceeded. For these reasons, servos are preferred for most high-speed applications. Conversely, the stepper's high pole count has a beneficial effect at lower speeds giving the stepper motor a torque advantage over the same size servo motor.

Open-loop stepper motors operate with a constant current and give off a significant amount of heat. Closed-loop control avoids the heat problem by supplying only the current that is demanded by the velocity loop. ▶



Figure 2: PRO2 servo motor (Photo: Servotronix)

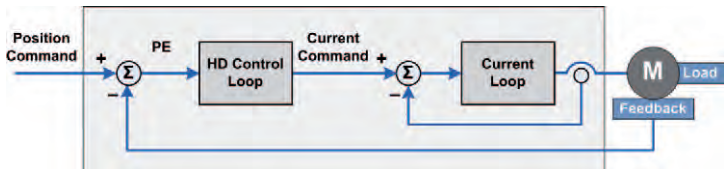

Figure 3: Position feedback in a closed-loop servo system (Photo: Servotronics)

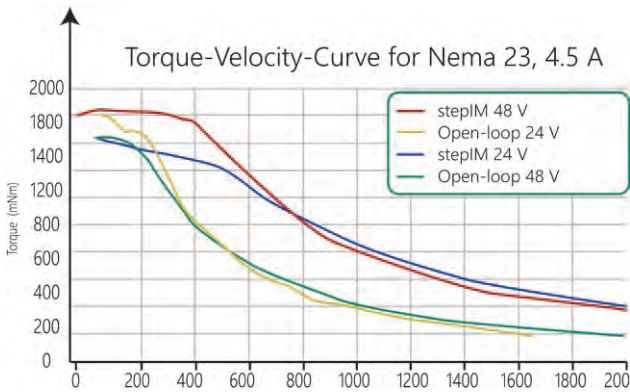

Figure 4: Stepper's Torque (Photo: Servotronics)

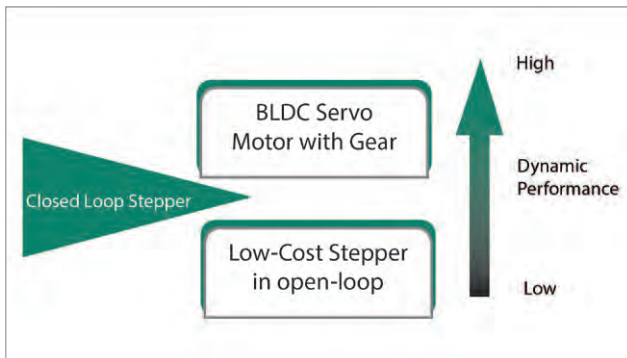

Figure 5: Closed-loop stepper motors step into high-performance, high-speed applications (Photo: Servotronics)

Traditionally, stepper drives were controlled by pulse train, EIA-232, EIA-485, and Modbus interfaces. However today, advanced steppers can operate in CANopen networks, significantly reducing wiring and cost while improving reliability and performance. CANopen uses standardized object libraries to perform CiA 301 application-layer functionality and efficiently supports CiA 402 modes/profiles such as Profile Position, Profile Velocity, Homing Mode, Profile Torque, and Cyclic Sync Position. Integrated stepper motors also support CANopen concepts like dynamic PDO mapping and synchronized motion making them efficient performers in a world of cross-vendor standards.

Servo control systems are best suited to high-speed applications that involve dynamic load changes like robot arms. Stepper control systems are preferred for applications that require low-to-medium acceleration and a high holding torque such as 3D printers, conveyors, and accessory axes. Because they are less expensive, steppers are favored as they can lower the cost of automation systems whenever they can be used. Motion-control systems that require the properties of servos must justify the higher cost of these motors.



CAN in Automation

# CANopen conformance test center

- ▶ Conformance testing of your CANopen implementation
- ▶ Interoperability testing in a multi-vendor test stand
- ▶ Test your devices together with other engineers at a plug-fest



For more details please contact the CiA office at [certification@can-cia.org](mailto:certification@can-cia.org)

[www.can-cia.org](http://www.can-cia.org)

## Altering perceptions

By adopting closed-loop technology, steppers are able to deliver the combined benefits of servos and steppers in a low-cost stepper package. Because of their performance and energy-efficiency improvements, closed-loop steppers can replace more expensive servos in a growing variety of demanding applications. Servotronics has embedded field-oriented, closed-loop control in its StepIM integrated stepper motors. The integrated electronics control the stepper motor as a two-phase BLDC motor, implementing position loop, velocity loop, DQ control, as well as additional algorithms. Closed-loop commutation, by means of an absolute single-turn encoder, ensures optimal torque utilization at any speed. Furthermore, closed-loop stepper motors are less noisy and vibrate less than open-loop stepper motors.

StepIM stepper motors are efficient consumers of energy. Unlike open-loop steppers that are always commanded with full current, resulting in heat and acoustic noise, the current to the StepIM motors flows only when needed, for example during acceleration and deceleration. Like servos, these steppers consume current proportionally to the actual torque required at any given moment. Since motor and integrated electronics run cooler, the steppers can achieve the higher peak-torque levels associated with servos.

### Close match to performance requirements

To make sure that there is enough torque to overcome disturbances and to avoid losing steps, open-loop steppers are routinely sized with at least 40 % more torque than required by the application. That becomes unnecessary with the closed-loop StepIM steppers. When these steppers are overloaded to a stall condition, they continue to hold against the load without losing torque. Upon removal of a blocking load, they continue to run. Maximum torque at any given speed is guaranteed while feedback of the position sensor ensures that no steps are lost. Thus, closed-loop steppers can be sized to closely match the torque requirements of their application without the 40 % extra margin. With open-loop steppers, high momentary torque demands are difficult to achieve due to the risk of losing steps. The closed-loop steppers are capable of fast accelerations, run more quietly, and have lower resonance than conventional stepper motors. They are also able to operate at higher bandwidths. The steppers integrate the electronics with the motor which results in a decentralized architecture, reducing cabling, and simplifying implementation, which enables the creation of cabinet-less machines.

### Steppers in high-precision woodcutting machines

Motion-control performances in a woodcutting application are traditionally performed with servos, but can be performed with closed-loop stepper motors. A global industrial automation company builds and sells hundreds of precision CNC machines to create wood frames for windows each year. Requiring precise synchronization and high torque, the application required some 20 to 30 pneumatic and

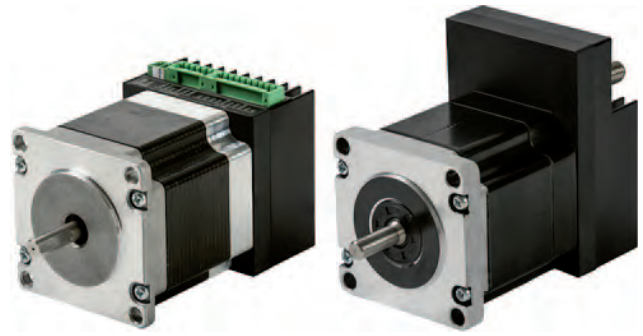

Figure 6: Servotronics's StepIM with closed-loop control (Photo: Servotronics)

electronic servo motors in each machine. The high cost of the servos contributed significantly to the overall cost of each machine. Furthermore, the substantial number of additional cables required by the stand-alone, cabinet-mounted servo drives extended installation time and added to the maintenance complexity.

Upon hearing about Servotronics's closed-loop stepper motors, the company was eager to determine their applicability to these wood-processing machines. "Cost has become a big factor in keeping our high-end machines competitive on a global scale," stated the Head of Development. "However, we could never compromise on performance, precision and reliability." If lower-cost, closed-loop steppers managed to achieve the performance targets, the company could use them in place of more-expensive servos, gaining a distinct advantage in the market. The company embarked on a pilot project to replace the servos in one machine with the StepIM integrated motors. Only the motors were changed; motion controllers and the communication protocol (CANopen) stayed the same. A significant simplification was to be realized as well: since the motors are integrated with the electronics, fewer cables are necessary. Less cabling means faster and less complicated setup time and maintenance.

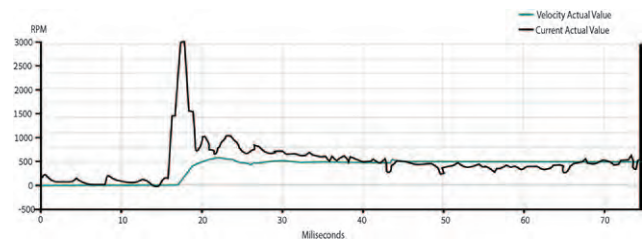

Figure 7: StepIM steppers require less current (Photo: Servotronics)

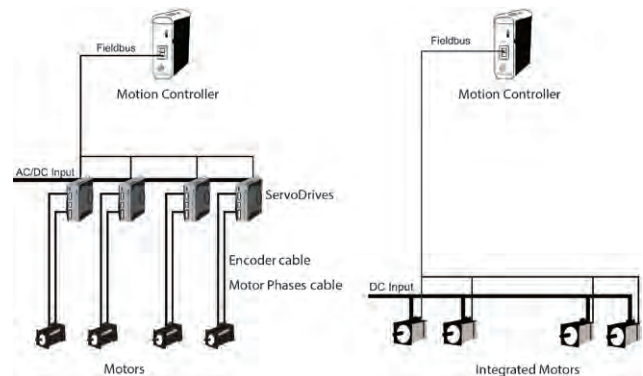

Figure 8: Centralized versus decentralized architecture (Photo: Servotronics)



Figure 9: Automatic positioning table for 5-axis CNC machine of wooden window frames (Photo: Servotronix)

After only a few months, and with technical support from Servotronix, the company was able to present its stepper-based machine in a trade show. The project manager was pleased to be able to meet all implementation targets. "We were able to pull out the servos from the target machine and replace them with StepIMs. Although we had some software to write and some preliminary testing to do, we got the machine working in a couple of months." The next step was to determine if the stepper-motor version of the machine could meet precision, acceleration, energy consumption, and other key performance indicators. After a month-long trial process, the company concluded that the closed-loop stepper motors allowed the machine to meet all specification and machine performance requirements while reducing complexity and cutting costs by over 5 % per machine. The company has now started to implement the stepper motors in 300 new machines and in other wood processing machines such as automatic edge benders.

Closed-loop stepper motors change the performance-cost ratio in motion control for many applications. High accuracy and energy efficiency enable StepIM stepper motors to operate in applications where more expensive servo motors have dominated. The field-oriented, closed-loop steppers are ideal for multiple-axis applications, positioning tasks with load changes, and applications that require quiet operation, short settling times, and precise positioning. Today, the stepper motors can be found operating in wood processing, medical equipment, printing and textile machines. ◀



#### Author

Dr. Markus Erlich  
 Servotronix Motion Control  
[markus.erlich@servotronix.com](mailto:markus.erlich@servotronix.com)  
[www.servotronix.com](http://www.servotronix.com)

# CAN FOR EXTREME ENVIRONMENTS

Fieldbus Coupler CANopen DSub XTR



750-338/040-000

## The WAGO-I/O-SYSTEM 750 XTR – Taking It To The Extreme

- eXTReme temperature ... from -40°C to +70°C
- eXTReme vibration ... up to 5g acceleration
- eXTReme isolation ... up to 5 kV impulse voltage
- eXTReme dimensions ... as compact as 750 Series standard

[www.wago.com](http://www.wago.com)



# *CAN in China: Still just a few local suppliers*

*CAN is well established in the Chinese automotive industry as well as in some other application fields. However, the domestic suppliers for CAN silicon and CAN-connectable electronic control units and devices are still rare.*

The Chinese economy is consolidating. The days of two-digit increasing rates are gone. President Xi Jinping targeted a 6,5-% [GDP](#) (gross domestic product) growth for 2017. The People's Republic faces a lot of challenges. In the automotive business, the most important market for CAN, the sign stood on green: In 2016, 24,4 million cars were sold, which is an annual increase of 15 %. Even if in 2017, these figures will not be achieved, the domestic brands growing last year by 21 % according to the China Association of Automobile Manufacturers will gain market shares from German and Japanese carmakers.

The government pushes e-cars and fosters the domestic brands. Great Wall Motor, the largest Chinese SUV provider, sold more than one million vehicles in 2016. Also the number one, Chongqing Changan Automobile produced more than one million cars. Even the sales of private-owned Geely increased to 760 000 cars. Volvo owned by Geely since 2010 had also a successful year: more than 500 000 cars worldwide including 90 000 sold in China. These numbers are still low compared with the biggest carmakers producing about 10 million vehicles per year.

The domestic car industry has adapted CAN technology and is looking forward to use CAN FD networks. Still struggling with the physical network design, the Chinese carmakers are already working on new in-vehicle network (IVN) architectures using CAN FD. The Chinese government forces domestic suppliers to develop CAN silicon and CAN-based board-level products in China. Guangzhou Zhiyuan Electronics, member of CiA since many years, is the first Chinese company implementing the CAN FD protocol into an FPGA. It will be used on the company's CAN FD interface products.

The e-cars need tested power batteries. "This is one of the most potential Chinese CAN markets in 2017," said Kiko Yue from Guangzhou Zhiyuan Electronics. "We plan

to launch an 8-channel CAN FD board, which will greatly improve the power battery testing intelligent level." In general, the CAN business for automobiles is also in China of strategic importance. NXP, the market-leader in CAN transceivers and a major player in the CAN controller market after acquiring Freescale, introduced recently at the CES 2017 in Las Vegas (USA) a partnership with Geely, a Chinese carmaker, who bought Volvo from Ford a couple of years ago. Geely regards high-end technology as a driving factor behind its growth plans. Volvo uses for example NXP chips in its prototype platform for self-driving cars.

The US government is a little bit nervous about China's semiconductor industry. China's objective to foster its domestic semiconductor industry by means of US-\$ 150 billion over the next decade is watched like hawks. The Obama administration already warned in a report: "We found that Chinese policies are distorting markets in ways that undermine innovation, subtract from U.S. market share, and put U.S. national security at risk." Already in August last year, U.S. President Barack Obama tried to block an acquisition of Aixtron, a German machine builder specialized in manufacturing metal-organic chemical vapor deposition equipment for clients in the semiconductor industry, by the Chinese Fujian Grand Investment Fund. Donald Trump is also not happy about the semiconductor industry sponsoring by the Chinese government. He twittered already in more or less clear words about a trade war between the world's two biggest economies.

In the last years, the CAN controller business was led by European and Japanese brands: Infineon, NXP, Renesas, and ST Microelectronics are just of few examples. US chipmakers were not involved in the IVN business; Microchip is not yet a heavy weight in this market. This changed with acquisition of NXP by the U.S. company Qualcomm in 2016. But what is about the Chinese chipmakers? Last year, ▶



Figure 1: The ambitious Jing-Jin-Ji project requires a lot of infrastructure in order to move people from their homes to the offices and factories, this may increase the sales of European supplier of CAN-connectable equipment for construction machines (Photo: CKGSB Knowledge)

Tsinghua Unigroup, China's largest chip designer, acquired a majority stake in XMC, one of China's leading chipmakers. The newly formed Yangtze River Storage Technology holding is not yet focused on IVN controllers. Also the other Chinese micro-controller vendors are not heavily involved in the automotive business. As Shanghai Huali Microelectronics, most of the Chinese foundries are suppliers for the Chinese companies assembling smartphones, digital cameras, etc. But this may change with increasing success of domestic carmakers.

## China plans to cut emissions

Although the Chinese government sponsors the development of e-cars, in order to improve the air-quality its megacities, there is second strategic plan to reduce smog: public transportation instead of individual traffic. The Middle Kingdom will cut, especially, the pollution of sulphur dioxide by 15 % in the next three years. Therefore, the share of public transportation should be raised to 30 % of the total traffic in the megacities.

The Chinese government wants to merge Beijing, Tianjin, and the Hebei region into a super-city with 130 million citizens. Nickname is Jing-Jin-Ji. The planned metropolitan area of the new city is six-times larger than New York. The idea is to link the facilities of Beijing with the Tianjin port-city. One of the challenges is to move the offices, factories out of Beijing in to the Hebei region. For this purpose, an efficient public transportation system is necessary. Unlike urban and metro areas that grow-up step-by-step, the Jing-Jin-Ji project is built on the drawing board. Besides high-speed trains, you need commuter trains and other local public transportation.

This will be a big business. No doubt the CRRC group, a state-owned enterprise, will take a big bite of the high-speed train business. In 2014, this group was so-to-say re-established by merging CNR and CSR, two companies separated in 2000. The regional and commuter trains as well light rail vehicles and metros are also produced by other enterprises. Even newcomers are approaching: BYD is an example. Known as carmaker, the company has already started with the development of mono-rail systems. It is intended to use a CANopen-based control system. CANopen-based control

systems have some history in Chinese metros and trams. Swiss-based Selectron introduced CANopen in China a couple of years ago.

The Jing-Jin-Ji project also will boost the construction machine business, which suffered in the last years. Whereas machinery sales in China are significantly down in almost all construction machinery product sectors, Off-highway Research identified a slight year-on-year increase in asphalt pavers of 4 %. In 2015 alone, 11 000 km of new highways were built, which makes Moba – the market-leading supplier of CANopen-based leveling and control systems for pavers – smile. Of course, Chinese competitors such as Jiangsu Siming S&T exist, but their quality of sensor products is lower than the German supplier's.

All the controller manufacturers suffered and are still suffering from the collapsing Chinese construction machine business. In 2015, the sale of road rollers dropped by 27,2 %, wheel cranes by 33,8 %, excavators by 41,4 %, loaders by 52,9 %, and tower cranes even by 60,5 % – just to give a few examples. This was an additional decrease compared to 2014, which was also a year of decreasing businesses. And worse, some customers (such as Sany) delayed payment of invoices significantly. Bankrupted companies paid not at all.

This should change, when the Jing-Jin-Ji megacity is going to take shape. Besides the above-mentioned railroads, bridges, and tunnels, there are also eight regional airports to be renovated and additional highways to be constructed. In the construction machine business, CAN and CANopen are set. This means, companies such as Cross-control, Epec, ifm, Shanghai Smart Control, and STW are looking towards a brighter future. At the Bauma Shanghai tradeshow in November 2016, they discussed new projects and developments.

This heavy-duty vehicle business is not limited to road construction machines and cranes. Recently, Liugong has launched its 45-ton CLG2450 reach stacker for container loading and unloading. The machine comprises advanced technology including negative flow feedback control, constant power variable control, temperature variable cooling control, touch control, and unified management of engine, gearbox, hydraulic sand braking systems using embedded CAN networks.

## The New Silk Road: One belt, one road

The Chinese machine-builders benefit also from the central government's Belt and Road Initiative. This refers to the Silk Road Economy Belt and 21<sup>st</sup> Century Maritime Silk Road. The strategy was launched in 2013 with the intention of promoting infrastructure business in the neighboring regions. Due to this initiative, Sany has managed to boost its sales in foreign countries and to reduce its reliance on the Chinese market. XCMG, one of the leading state-owned Chinese OEMs, has invested US-\$ 150 million in a manufacturing unit in India through partnership with Schwing Stetter India. Schwing, a Germany-based concrete pump manufacturer is part of XCMG. Competitor Putzmeister, also headquartered in Germany, has been acquired by the private-owned Sany, another Chinese OEM.

The New Silk Road strategy is not limited to construction machines and to Chinese neighbor countries. Beginning of 2017, a freight train left Zhejiang province in eastern China to travel 12 000 km to London. Up to now, the U.S. administration regarded the New Silk Road as a bringer of security and of stability to Central Asia. But this may change: Donald Trump may see the Chinese export activities as a hawkish posture. Also the ancient Silk Road was connecting the Far East with Europe. It was a bi-directional link. The New Silk Road is also a two-way connection: Europe provides technology including CAN and gets back machines and other equipment. China has invested about US-\$ 250 billion into the New Silk Road. This includes energy projects, railroads, and port facilities in Europe and around the rim of the Indian Ocean. This is not just an investment, but part of a geopolitical strategy.

### The Chinese “robot army” is growing

In the past, labor costs were low in China. In the meantime, machines installed in Chinese factories are increasingly sophisticated. They require educated and trained users. Those employees do not work for peanuts; they want to get a fair salary. Many of the machines developed in China use CAN and CANopen as embedded networks. Schneider Electric, Lenze Schmidhauser and other mainly European suppliers have equipped a lot of machines developed and manufactured in China with CANopen-based controllers and

#### Five euros an hour

U.S. President Donald Trump regards the labor market as a zero-sum game. In last decades, many U.S. companies have moved production to China. Trump promised to bring those jobs back home. But many of the qualifications needed for the homecoming jobs are not more available. It is hard to re-shore jobs that no longer exist.

It took 50 years to install the first million industrial robots. The next million will need only eight years. And most of the growth is coming from China, which has an aging population with a decreasing number of workers. This is one major reason why China is installing more industrial robots than any other country. United Nations already warned last year, that two-third of jobs in developing countries are at risk. The U.S. government should be concerned because the middle-classes in China are potential customers for U.S. products. If they have no jobs anymore, they also have no money to buy goods made in U.S. Economy is not that simple as Donald Trump describes in his Tweets.

Kuka acquired last year by the Chinese Midea Group estimates a typical industrial robot costs about € 5 per hour. German manufacturers spend about € 50 an hour for a worker, in China it is just € 10. The return of investment for an automotive welding robot in China has fallen to less than two years. This means, what Donald Trump could increasingly bring back home are robots, not jobs for U.S. citizens. hz



Figure 2: The USB dongle with eight CAN FD ports is based on an FPGA designed in China (Photo: Guangzhou Zhiyuan Electronics)

drives. Local brands have adapted CANopen in PLCs, servo controllers, and stepper motors as well as HMI devices. Kinco, a long-time CiA member, is just one example. The company also supplies to the medical device and healthcare manufacturers.

The next step is already announced: Chinese companies will heavily use robots in their factories. Foxconn, the Taiwanese enterprise manufacturing Apple's iPhone in China mainland, is going to fully automate the production. The company said it has a three-phase plan to introduce robots. In the first phase, just the work that is either dangerous or involves repetitious labor humans are unwilling to do will be done by robots. The second phase involves improving efficiency by streamlining production lines to reduce the number of excess robots in use. In the final phase, only a minimal number of workers assigned for production, logistics, testing, and inspection processes are in the factories. Foxconn likes to automate 30 % of all production by 2020.

According to the market researcher from ABI, industrial robots increase annually in average by 16 % in the next four years. This will sum to US-\$ 30-billion revenue in 2020. The automotive industry will be still the most important market, even if other applications such as electronics and plastic processing will catch up. But food and food packaging, pharmaceutical, and cosmetics production will have the higher growth rates.

"The industrial robotic market is driven by the demand for increasing levels of speed, precision, and production flexibility," said Philip Solis from ABI Research. "Other demand contributors include the introduction of robotics automations into industries that did not previously benefit from robotic industrial automation or new classes of applications. Governmental and political manufacturing initiatives, such as entrepreneurship and investment programs, as well as public-private partnerships and re-shoring efforts, also provide momentum for the sector."

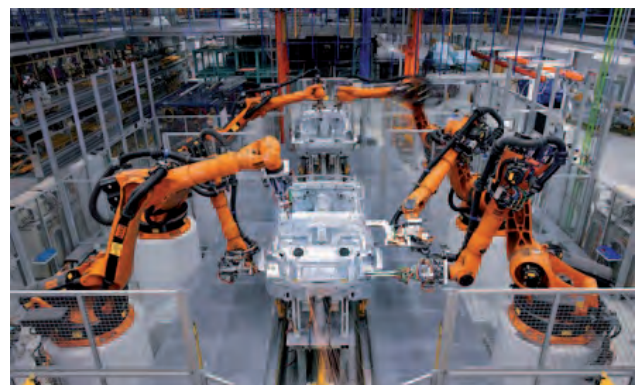

Figure 3: Chinese companies are buying especially high-tech companies in Europe, for example, Kuka located in Germany manufacturing industrial robots (Photo: Kuka)



Most of the industrial robots are used in Far East countries. This makes about 65 % of the world market. One third of the global market goes to China. ABB accounts for nearly one-half of worldwide shipments, with Yaskawa Electric, Kuka Robotics, Fanuc, Kawasaki Precision Machinery, Yamaha Robotics, Stäubli, Nachi Fujikoshi, and Epson Robots as other major suppliers. So, it is not surprising the Chinese Midea Group acquired recently Kuka, one of the leading robot company. The price was US-\$ 5,2 billion. China tries to catch up in technology by buying European companies, a strategy already known from the construction machine industry. The latest acquisition is Gimatic, an Italian pneumatic and electric grippers, sensors, and positioners maker, by Agic Capital for far more than US-\$ 100 million. Last year, Agic has purchased in cooperation with Chemchina and the state-owned investment company Guoxin Krauss-Maffei, a German industrial robot integrator and plastic-processing machine builder for about US-\$ one billion. The Chinese companies are also shopping in the U.S. Wanfeng bought Paslin, a Michigan integrator of welding robots, automation systems and tooling, for about US-\$ 302 million. Siasun Robot & Automation, a Chinese robot manufacturer, announced that they are planning to acquire competitive and domestic as well as international device manufacturers.

According to the International Federation of Robotics (IFR), annual robot sales between 2005 and 2015, rose 9 % worldwide, while the growth in China was reported as 25 %. International vendors produce more than two-thirds of the robots purchased in China, but this ratio will change in the future. The current 5-years plan requires an increased use of robots. Some of these robots implement CAN-based embedded networks linking sensors and servo drives as well as other devices.

The robot market is not limited to industrial applications. China and the other Asian countries, in particular Japan and South Korean, are developing service robots (see page 26). Service robots and industrial robots cooperating with human beings have a lot of similarities. Standardizing of electronic module interfaces would allow using devices for both applications. CANopen is a good candidate. Some robots already implement CANopen (see page 30).

China needs robots to keep the production growing, said a study by McKinsey Global. Without robots and automated production, China will be short 600 million workers to achieve the planned GDP growth rates. China has an industrial robot density of 49 per 10 000 workers, while South Korea has 531, the highest density. But China is already the biggest robot market, said the IFR. The “Made in China 2025” initiative launched in 2015 requests to modernize the factories with more robots.

### Low-cost CAN boards

Professional CAN-connectable devices are increasingly developed and produced in China. But most of the sophisticated and advanced CAN products are imported from Europe. There is one exception: Low-cost equipment for hobbyists, “makers”, and researchers. CAN shields for open-source hardware come from the Middle Kingdom. They are mainly based on Microchip’s CAN stand-alone controller



Figure 4: Professional CANopen products designed and manufactured in China are still rare, the CANopen stepper motors by Kinco are used for example in the shown corrugated slitting machine (Photo: Kinco)

and transceiver chips. Also low-cost drones and multi-copters are a domain of Chinese companies. Some of them are equipped with a CAN interface.

CAN technology is popular in China. But the knowledge is still limited. Available literature is product-oriented and does not provide background information to make proper hardware and software designs. This changes – but not that fast, as it is necessary. What is missing is a better education in the university on the basics of technical communication systems. Engineers designing embedded networks and deeply embedded networks also need to understand the application. Young engineers coming from the universities are not educated in this direction.

Low-cost is a key criterion in China. For example, Chinese companies have taken over the solar power business from European suppliers. Nowadays, most of the photovoltaic panels are produced in China – for a lower price, of course. The government has financially supported this industry. In the meantime, Chinese companies are also designing complete renewable energy systems. For example, two Chinese companies, a subsidiary of Golden Concord and state-owned China National Machinery, plan to invest US-\$ one billion for a solar farm on land contaminated by the nuclear accident in Ukraine in 1986, reports the Climate News Network. The 1-GW plant will be built and run by the Chinese enterprises. Solar plants with sun-tracking panels often use embedded CAN networks to interconnect the inclinometers. Sometimes also the inverters are CAN connected. There are increasingly Chinese suppliers developing inclinometers and other equipment for photovoltaic systems implementing CAN connectivity.



#### Author

Holger Zeltwanger  
CAN Newsletter  
[headquarters@can-cia.org](mailto:headquarters@can-cia.org)  
[www.can-newsletter.org](http://www.can-newsletter.org)

# Safety CAN: Why and how?

*Why should a safety-related CAN protocol be used? Is it necessary? And if so, which protocol is the most feasible? We take a look at where the demand for safety protocols comes from and at existing technical solutions.*

If you want to place a product like a machine or a vehicle on the market, you have to consider the legal requirements. Those are specified in national laws like the [Product Liability Act](#) or European directives like the [Machinery Directive](#) or the [Regulation for Vehicle Type-Approval](#). All of them refer to state-of-the-art technology, which is described by the harmonized product

or sector standards. For any kind of machine with safety-related parts of a control system, the most commonly used standard is ISO 13849. Concerning data communication, it refers to IEC 61508-2, providing a choice of two data communication architectures. With the White-Channel, the entire transmission path has to be developed compliant to the standard, whereby with the Black-Channel, only the endpoints are considered safety-relevant and the transmission is protected via a safety protocol. In both cases, for non-rail applications, IEC 61784-3 “Functional safety fieldbuses” is referred to, whose principals have been implemented for example in the CANopen Safety standard EN 50325-5.

For road vehicles, ISO 26262 defines a number of techniques to reach the required diagnostic coverage for a communication network like CAN. Those are for example information redundancy, timeout monitoring, or frame counter, which are needed to detect faults like corruption of information, delay of information, or loss of information. Even if the standard does not explicitly claim a standardized protocol, especially the interconnection of parts or systems of different manufacturer makes the use of common protocols more efficient than investing in a proprietary solution. However, what are the use cases for those protocols? Let us have a look at a simple application: A sensor measures pressure and the data is processed by a control unit. At the end of the control path there is some kind of actuator on the machine or vehicle, like a pump switch, which is regulated by another control unit. The units are interconnected by a bus system. The hazard and risk analysis orders the pump to switch off if the pressure exceeds a threshold value. In consequence, you have to build a safety function by using a highly reliable or safety-related sensor and actuator as well as two safety-controllers. But how

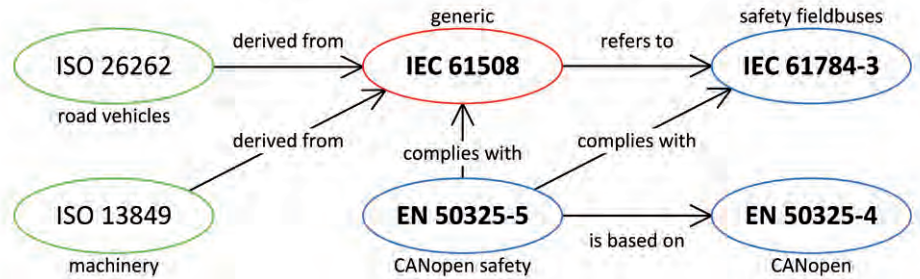

Figure 1: Relationship of the relevant standards (Photo: STW)

do you ensure that the switch-off signal is transmitted reliably? You could wire an additional safety-related signal line between the control units or you use the existing non-safe communication channel in combination with a safety protocol.

As CAN is still a widespread bus system in the industry, let us have a look at the technical solutions for this standard. With the rising need for safety-related CAN communication, several companies have come up with ideas on how it can be realized. As an example, [Pilz](#) developed Safety BUS p, which is an event-driven CAN protocol and primary used in fabric automation. By adding additional measures to the OSI layer 2 and 7, it is made suitable for safety applications up to SIL 3 according to IEC 61508. Transmission errors and device errors are detected by a combination of sequential numbers, timeout detection, echo check, IDs for transmitter and receiver, as well as data protection with CRC.

In 1993, the CANopen protocol was developed within a European research project under the chairmanship of Bosch. Because this OSI layer 7 protocol – also known as the [CiA 301 specification](#) – was very successful, it was enhanced to CANopen Safety (CiA 304) for safety-related automation applications up to SIL 3 according to IEC 61508. An additional message object makes it possible to transmit safe and non-safe data on the same communication line. The safety-related data object (SRDO) consists of twice the same data but once inverted. The two

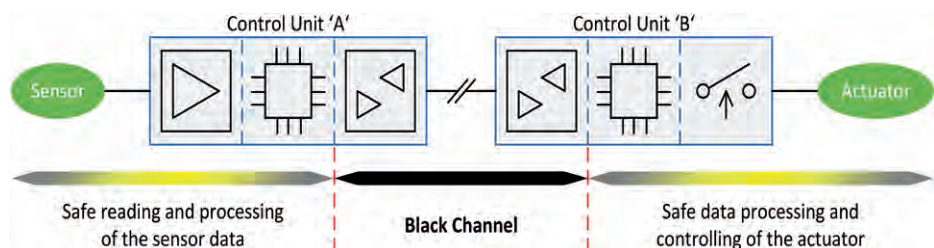

Figure 2: Example of a safety function (Photo: STW)

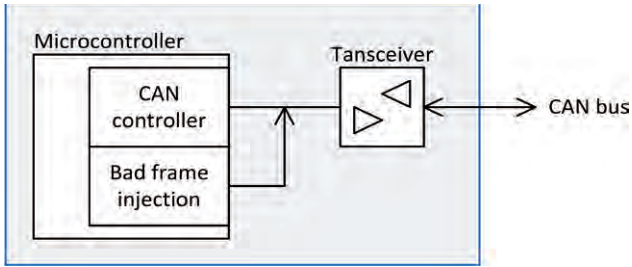

Figure 3: Bad frame injection to test the CAN controller (Photo: STW)

CAN messages of an SRDO have to be transmitted within the safety-related validation time (SRVT) and periodically within the safeguard cycle time (SCT).

One problem of this protocol is the CRC of the CAN messages being part of the safety mechanism and therefore its integrity has to be guaranteed. This is why the receiving part has to provide a redundant CAN controller, because it is supposed that the CRC calculation might be corrupted. This has been implemented for example on the CANopen Safety chip CSC01 and its successor CSC02 by [Systec Electronic](#) on the basis of a 16-bit micro-controller. Although the marketing of the chip has been stopped, the technical principal is still state-of-the-art. Sensor-Technik Wiedemann has found a solution to omit the second CAN controller through a test of the CRC mechanism. For this purpose, at start-up a corrupted CAN frame is injected into the receive line, to check if the CRC hardware finds the error. With this measure, SIL 2 according to IEC 61508 can be achieved.

Another problem of the CANopen Safety protocol is that the two CAN messages of the SRDO lead to a heavy busload if many participants are sending on the bus. Therefore, Sensor-Technik Wiedemann has developed an optimized CAN safety protocol named ESX CAN efficient Safety (ECeS). The concept of this protocol is that only six of the eight data bytes of a CAN message are used for information. The remaining two bytes contain a message counter and an 8-bit CRC with a suitable hamming distance. Together with a defined SCT and the bad frame injection test, this protocol can be used for safety applications up to SIL 2 according to IEC 61508. The data throughput of ECeS exceeds CANopen Safety.

At this point of our examination, we can already say that using a safety-related CAN protocol is not an option but mandatory for CAN applications with requirements on functional safety. The type of protocol mainly depends on the kind of application and especially on the question, which and how many other participants are involved in the safety function, and which protocol is implemented or can be implemented on them. ◀

**Author**



Philipp Luger  
 Sensor-Technik Wiedemann  
[info@sensor-technik.de](mailto:info@sensor-technik.de)  
[www.sensor-technik.de](http://www.sensor-technik.de)

# POSITAL FRABA

## SENSORS FOR MOBILE MACHINES



### Absolute Rotary Encoders and Inclinometers

**Reliable Measurement under  
Harsh Conditions**

High Protection Class up to IP69K

Fieldbus and Analog Interfaces

Safety, Redundant and ATEX  
Ex-Proof Versions Available

Successfully Integrated in  
Concrete Pumps, Drilling Machines,  
Working Platforms, Cranes, Wheel Loaders,  
Leader Masts and More

Choose from over 1 Million Sensors



The Easiest Way to Find the Product you Need!

[www.posital.com](http://www.posital.com)

# Autosar SecOC for CAN FD

*With the migration to CAN FD, new security concepts have become possible: It enables the Autosar concept Secure Onboard Communication, which detects attacks on the network.*

For more than 20 years, CAN has been and still is the dominating communication system in vehicles. With the rising complexity of in-vehicle functions, Classical CAN cannot satisfy the increasing demand for an effective data rate any longer. Therefore, CAN FD was introduced – it allows for a payload up to 64 byte to achieve data rates of 2 Mbit/s and 5 Mbit/s. To exploit this major advantage for advanced functions, challenges of larger network topologies have to be addressed. In particular, the so-called ringing effect has a tremendous impact on the communication reliability. One of the major benefits of CAN FD is that it enables security for single protocol data units using the Autosar concept Secure Onboard Communication (SecOC).

## Ringings

In CAN FD networks with more than two nodes, reflections of communication voltage waves, which occur because of impedance mismatches in a network at the signal transition frequencies, generate ringing. The impedance mismatches occur mainly at non-terminated nodes and the junction. When a transmitter outputs a recessive state, the output of the transmitter has a high resistance. Therefore, signal ringing occurs in particular during the transition from recessive-to-dominant. In addition, a negative reflection occurs at the junction because the impedance decreases. This results in a lower impedance than the characteristic impedance. If ringing does not converge below a predetermined voltage until the defined sampling point, a bit malfunction occurs.

To avoid this, we developed the so-called RSC – ringing suppression circuitry. This circuitry detects the change from dominant to recessive state and changes the impedance to 120 Ohm. An internal MOS component detects this falling edge and activates the ringing suppression. This suppression circuit can be seen as a circuit comprised by resistors and switches, which take the energy out of the network. RSC was designed to be compatible to all ISO 11898-2-compliant

transceivers. Therefore, it can be used in CAN FD networks and allows engineers to develop software using all technical advantages of CAN FD. RSC is already specified in CiA as CiA 601-4, with ongoing continuous improvement of 601-4 as well as standardization activities on ISO-level (11898-2).

## CAN FD to completely enable SecOC

The Autosar concept Secure Onboard Communication (SecOC) was specified to check the authenticity of a single transmitted protocol data unit, in order to detect attacks such as replay, spoofing and tampering. As the recently published hacks have shown, gaining access to the CAN network is typically the only barrier to taking remote control of a vehicle. Once on the bus, the attacker can imitate a legitimate sender and gain control of the behavior of the entire vehicle. With SecOC, the attacker also has to know the sender's secret key. Assuming proper system design, this is only possible by physical access to the vehicle and destruction of the respective control unit. Therefore, such attacks can be prevented.

The SecOC module calculates and adds a message authentication code (MAC) to the protocol data unit. For replay protection, a freshness value has to be included in the cryptographic calculation. The PDU is transmitted together with the MAC and freshness value in one frame. With Classical CAN, only a part of the freshness value for synchronization and only a part of the MAC can be added due to the limited frame size of 8 byte. The receiver then calculates the MAC of the PDU and the freshness value and compares it with the one it (partially) received. If there is no match, the PDU is dropped and ignored.

However, some issues with the application of SecOC to serial products remain. Challenging topics, not dealt with by the standard, are the key management, freshness value handling, and recovery strategy. The recovery strategy for instance is how to deal with failed authentications, how to ensure the functionality or at least the safety of the system

in such a case, and how to recover the system operation when participants are out of synchronization. Another critical factor is the Classical CAN frame, which provides only 8 byte of payload. While NIST recommends truncation of the MAC below 64 bits only in conjunction with a careful analysis, a Classical CAN message would be entirely occupied by the MAC and leave



Figure 1: Left: Conventional CAN FD transceiver; right: Denso RSC transceiver (Photos: Denso Automotive Deutschland)

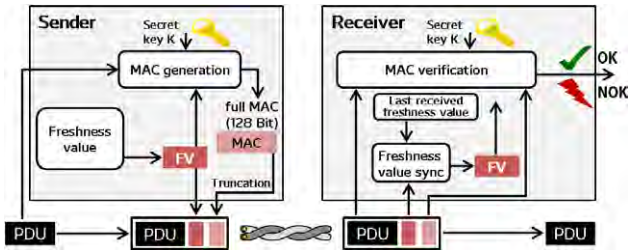

Figure 2: Process of secure onboard communication in Autosar (Photo: Denso Automotive Deutschland)

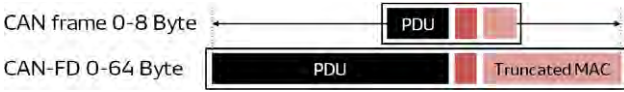

Figure 3: CAN FD has the potential to increase both security and efficiency (Photo: Denso Automotive Deutschland)

no space for the actual payload. To retain a decent communication efficiency, the MAC must be truncated to a shorter length, which also reduces the level of security the MAC can provide. The MAC could also be sent in another frame, which improves the security but has quite an impact on the busload and communication effort. By switching to CAN FD, the payload of up to 64 byte allows the transmission of a reasonable amount of data in conjunction with a "secure" MAC length. Ultimately, the limitations of Classical CAN hinder the wider and more effective introduction of essential security technology. Therefore, CAN-based mission-critical communication should follow the evolution to

CAN FD in order to accelerate the inevitable introduction of new features. RSC enables the design of large CAN FD networks to make full use of CAN FD's advantages.

## Summary

Autosar Secure Onboard Communication is limited in Classical CAN networks due to its payload of only 8 byte. With CAN FD, SecOC can be used without limitation such as MAC truncation and omission of freshness synchronization. However, CAN FD cannot be deployed as easily as Classical CAN. For larger networks, either the topology has to be reduced in complexity or other technologies have to be applied to attenuate ringing effects. The use of RSC simplifies the upgrade to CAN FD for any existing (Classical CAN) topology and also allows for more freedom in the topology design.

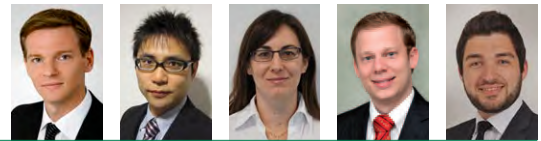

## Authors

Dr. Tobias Islinger, Yasuhiro Mori, Jennifer Neumüller, Martin Prisching, Dr. Robert Schmidt  
Denso Automotive Deutschland GmbH  
[t.islinger@denso-auto.de](mailto:t.islinger@denso-auto.de)  
[www.denso-auto.de](http://www.denso-auto.de)

# LIN&CAN Tools for test and production

Configure - Connect - Operate  
We support you all the way!  
+ 49 6151 93591-0



LIPOWSKY  
INDUSTRIE-ELEKTRONIK

SINCE  
1986  
ISO 9001 : 2008

[www.lipowsky.com](http://www.lipowsky.com) [info@lipowsky.de](mailto:info@lipowsky.de)

Distribution China: Hongke Technology Co., Ltd  
Distribution USA: FEV North America Inc.

Ph: +86 400 999 3848  
Ph: +1 248 293 1300

sales@hkaco.com [www.hkaco.com](http://www.hkaco.com)  
marketing\_fev@fev.com [www.fev.com](http://www.fev.com)

# Ada language for automation

*Ada for Automation (A4A) is a framework for designing industrial automation applications using the Ada language. It makes use of Hilscher boards and can exchange process data via CANopen.*

Today, control applications are getting more and more complex, involving motion control, databases to store recipes, parameters, alarms and events, networks to exchange information with other intelligent nodes (machine-to-machine communication), human-to-machine interfaces either rich or constrained, web user interfaces to allow interaction from abroad, and so on. Of course the situation won't become simpler in the future with the Internet of Things or Industry 4.0. A wide range of automation products is available on the market and the borders between them are moving. For example, drives can come with an integrated PLC and a PLC can have encoder inputs and control loops. Some PLCs have integrated web HMI, some panels have a soft PLC.

Thus, the task of control engineers is becoming increasingly difficult, first to select the right combination of hardware and software and then to master all the necessary tools and languages. Languages created for control engineers like Ladder or Instruction List are not always adapted to the task at hand. Standards help maintain a kind of consistency and there is a chance to end up with a working solution, but at what price? Solutions are often like Frankenstein's creature if you want them to be attractive: after some time, tools become unsupported and obsolete, if they are still available.

Most users of automation products fall either in the C/C++/C# industrial/embedded computer programmer or the IEC 61131-3 PLC programmer world. While coming from the world of computer science as a C programmer and then having learned object orientation using C++, I am a fan of the Ada language, which I think could be a very interesting bridge between those worlds. Users of the Structured Text (ST) language will find the syntax of [Ada](#) very similar and indeed they share same Pascal influence. Born in 1983 as a general purpose language suitable for long lived applications ranging from embedded systems to the largest ones, Ada evolved in 1995, 2005, and 2012 to provide every feature needed from low-level hardware interaction on bare metal to modularity, object orientation, tasking, and more, with a runtime system allowing the same application code to be compiled for any supported target Operating System. The main goals during the design phase of Ada were sustainability and reliability and there is no doubt industrial applications share the same requirements.

I wanted to learn the language and found that a framework for building automation applications making use of Hilscher boards would be great since I am a Hilscher France technical support guy. This is my own project, not endorsed by the Hilscher company.

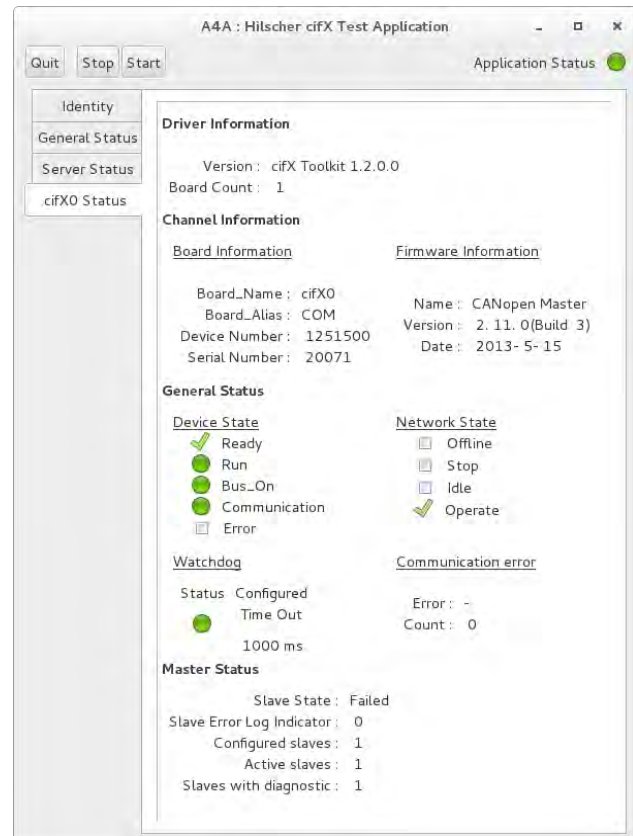

Figure 1: Screen shot showing the GtkAda GUI of a Hilscher cifX board running a CANopen NMTmaster firmware on a Debian Linux machine (Photo: Stéphane Los)

## Framework for design of automation applications

A4A is a framework for designing industrial automation applications using the Ada language. It makes use of the Libmodbus library to allow building a Modbus TCP client or server, or a Modbus RTU master. It can also use Hilscher communication boards allowing to communicate via fieldbuses like AS-Interface, CANopen, CC-Link, Devicenet, Profibus, Ethercat, Ethernet/IP, Modbus TCP, Profinet, Sercos III, Powerlink, or Varan. Ada Core provides an open source [IDE and compiler/runtime](#) and a [learning platform](#). Debian GNU/Linux provides the same IDE in an older version and many libraries one can use with Ada.

Thanks to Ada, an application built using Ada for Automation works with Microsoft Windows, Linux, and Linux with PREEMPT\_RT patches, down to the millisecond cycle time. It could also work on QNX or Vx Works without much, if ▶



any, code modification, since the Ada runtime takes care of providing the same services on all supported platforms. Thanks to [GtkAda](#) it can be built with a GUI. It can be built

without of course. Thanks to [Simple Components](#) it can send you emails or talk to the cloud. Thanks to [Gnoga](#), built upon Simple Components, it can be built with a Web GUI. It can also be built without one of course. Gnoga allows to manipulate the DOM of web pages, attaching to or creating HTML or SVG elements that can be animated from the Ada code. Ada for Automation is 100 % Ada, which makes all Ada resources, resources for Ada for Automation. Since Ada allows the use of any C library, Ada for Automation can also use them as well.

Some may consider Ada to be a language of the past but it seems pretty alive and in line with upcoming trends. "Over the past few years, Ada support on targets typically used by the automation industry has increased significantly. It started with a port to an 8-bit micro-controller, the AVR ATmega256, in 2009, demonstrating that the Ada language was a viable choice for programming applications on low power low memory architectures. Since then, the main focus has been on ARM and in particular the ARM Cortex series. Bare metal cross compilers to Cortex-M and Cortex-R series were released in 2014, followed by Cortex-A microprocessor support for Embedded Linux, Raspberry Pi, VxWorks, and also Android and iOS. On the ARM micro-controller side of things, Ada support first appeared on community-available devices, such as the STM32F4 Discovery from ST, SAM4S from Atmel, and TMS570 from TI. Since these beginnings, the set of devices with available board support packages and drivers has continued to expand, notably through Ada Core's community [Github](#). The CMSIS-SVD driver format provided by most hardware vendors has proved to be a significant help here. Ada specifications can now be generated directly for device memory and interfaces, providing solid foundations for driver development. As a successful demonstration of this effort, this year's first Ada maker contest [Make with Ada](#) attracted more than 30 submissions, primarily targeting those ARM Cortex micro-controllers," said Quentin Ochem, head of business development and technical account management at Ada Core. One of the bold features of Ada for Automation is brought by the Ada binding of the Hilscher cifX library, the Application Programming Interface (API), which allows the use of Hilscher communication boards.

## Data exchange via CANopen

With any industrial communication protocol, data exchange is established either cyclically, for all process data like set-points and measures, statuses and commands, or acyclically for configuration, parameterization and diagnostics. Taking CANopen as an example, the process data exchange is carried out by PDOs (Process Data Objects), while parameterization is done using SDOs (System Data Objects). In addition, services like node management are also provided as acyclic messages. Similarly, with Devicenet, which implements CIP (Common Industrial Protocol), assemblies carry such process data as implicit ▶

# All you CAN plug



CANopen®

CAN<sup>FD</sup>

## CAN-PCI/402 CAN-PCIe/402 and CAN-PCIe/402-FD

- up to 4 (-FD: 2) high performance CAN interfaces powered by esd Advanced CAN Core (ACC)
- DMA busmaster and MSI support
- High resolution hardware timestamps

## CAN-USB/400

- 2 high performance CAN interfaces powered by esd Advanced CAN Core (ACC)
- CAN error injection capabilities
- High resolution hardware timestamps
- IRIG-B time code option

The esd Advanced CAN Core (ACC) powered CAN/400 board series is also available in CompactPCI, CompactPCISerial, PMC, XMC and µTCA form factors.

## Operating Systems

esd supports the realtime operating systems VxWorks, QNX, RTX, RTOS-32 and others as well as Linux and Windows 32/64 Bit systems.

## CAN-Tools

Our efficient CAN monitoring and diagnostic tools for Windows like CANreal, COBview, CANplot, CANscript and CANrepro are delivered together with the Windows/Linux driver CD free of charge or can be downloaded at [www.esd.eu](http://www.esd.eu).

 **embeddedworld2017**  
Exhibition&Conference  
... it's a smarter world  
**Hall 3A, booth 221**  
**in Nuremberg 14.-16.03.2017**

 **HANNOVER  
MESSE** **Hall 9, booth F17**  
**24.-28.04.2017**



esd gmbh  
Vahrenwalder Str. 207  
30165 Hannover  
Germany  
Tel.: +49-511-3 72 98-0  
[info@esd.eu](mailto:info@esd.eu)  
[www.esd.eu](http://www.esd.eu)

US office:  
esd electronics, Inc.  
70 Federal Street - Suite #2  
Greenfield, MA 01301  
Phone: 413-772-3170  
[us-sales@esd-electronics.com](mailto:us-sales@esd-electronics.com)  
[www.esd-electronics.com](http://www.esd-electronics.com)

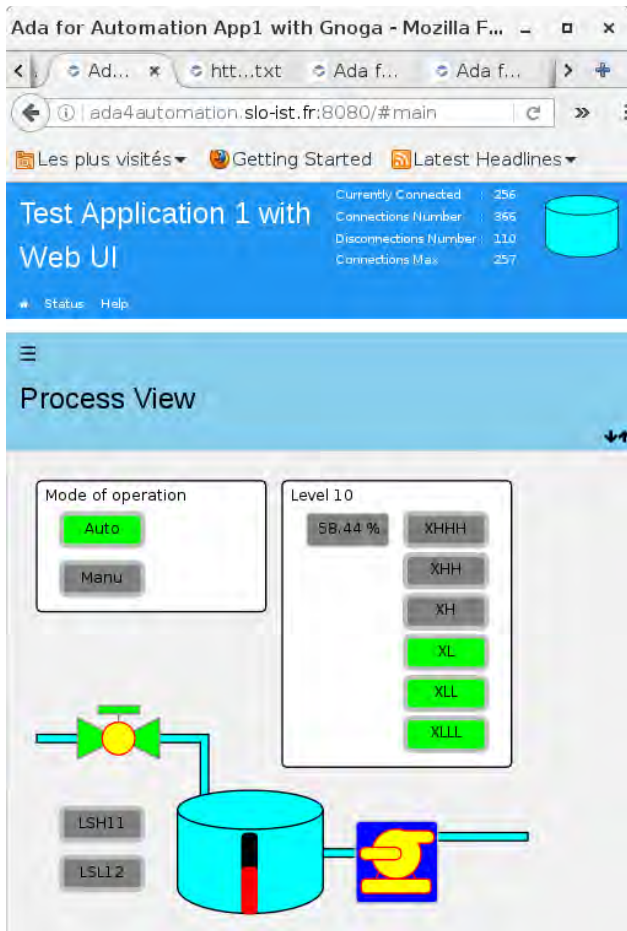

(Photo: Stéphane Los)

data, configured once during startup, while services like Get or Set Attribute allow so called explicit access to parameters and configuration data.

For this reason, Hilscher has defined a generic interface, the Dual Port Memory (DPM), which has a standard layout independent of the protocol stack running on the netX system-on-chip. The DPM layout provides a process data image with input and output areas for the cyclic data exchange, and message boxes for sending and receiving packets for acyclic communication. Control and status areas for hardware and software identification, general commands, and diagnostics are also provided. The cifX API provides all necessary functions to access the DPM through the user interface of the cifX driver available on all major Operating Systems. Header files are provided in the C language.

With Ada for Automation, the user gets not only an Ada binding allowing the use in the Ada language but also a rather complete infrastructure. On top of the cifX API, an infrastructure has been built, which takes care of the driver initialization, hardware and firmware identification, cyclic refresh of the process image, watchdog management, monitoring of the communication status and more. This infrastructure also has a system managing acyclic communication with message queues, routing and function blocks for the user application program. Since it is necessary to be able to configure and diagnose those cifX boards, the Hilscher netX Diagnostic and Remote Access protocol has been integrated as well and allows the use of Hilscher's configuration tool, Sycon.net via TCP/IP. As expected, several application examples are available which demonstrate the potential use of the

infrastructure and, thanks to Ada, these applications are running on the supported operating systems without modifying a single line of code.

Since the Hilscher cifX API is available for most Hilscher products, including cifX boards, com X, Netrapid and Netjack modules, and also Nethost which is like a cifX board accessed via TCP/IP, Ada for Automation can make use of all those products and can be a CANopen Master or Slave, respectively a Devicenet Master or Slave. Parallel to the CANopen communication, Hilscher boards also offer access to the CAN layer allowing to communicate with other Classical CAN devices (11-bit and 29-bit identifier) letting you implement other protocols like Layer Setting Services (LSS) for example or roll your own.

With Ada for Automation and Hilscher cifX boards, any industrial PC can become a powerful control target. But simple applications could benefit from the inexpensive CPUs available today on the market. Experiments have been conducted successfully using the Raspberry Pi with Netrapid modules via the fast SPI connection to the DPM and with Nethost via TCP/IP. The netX system-on-chip can have up to four communication channels. Hilscher has created boards with two CANopen channels, two Devicenet channels, and even one CANopen and one Devicenet channels. The cifX API allows up to four channels per board and there is no limit to the number of boards. On top of this communication infrastructure, the next step would be to implement Ada objects based on the objects specified by CiA in the CANopen profiles or by ODVA in CIP profiles. This could lead to an object library of devices implementing standard features like drives or encoders. Thanks to the object orientation and inheritance, a manufacturer could then provide a derived object implementing manufacturer specific features. Dreaming a little further, a [motion control library](#) like the one specified by PLCopen would allow a control engineer to build motion applications with standard components. I would love to create such [CNC](#) but using a CANopen drive, motor, and encoder. The project is of course looking for contributions and sponsors. ◀



#### Author

Stéphane Los  
Ada for Automation  
[stephane.los@slo-ist.fr](mailto:stephane.los@slo-ist.fr)  
[www.slo-ist.fr](http://www.slo-ist.fr)



# The Ultimate CAN FD Tool



## neoVI FIRE 2

### Vehicle Interface & Data Logger

Standalone gateway functionality between DoIP, CCP/XCP, CAN FD, CAN, LIN, and Automotive Ethernet.

Device includes:

- 8x ISO CAN FD
- 4x LIN
- Ethernet: DoIP/XCP
- Hardware Cybersecurity
- Standalone Logging, Scripting, & Simulation
- Full Vehicle Spy Software Support



Find out more at [www.intrepidcs.com](http://www.intrepidcs.com)



**INTREPID CONTROL SYSTEMS GMBH**

USA Germany Japan Korea China India Australia  
+49 (0)721 6633703 -4 [icsgermany@intrepidcs.com](mailto:icsgermany@intrepidcs.com)

# Amsterdam brewer's drayman go electric

*Electric drives open up possibilities for future-focused ecological and economical vehicle concepts. The trucks with Lenze's Mobile inside are part of the company's strategy to reduce the brewery's carbon footprint.*

Figure 1: Brewery drivers go electric:  
The delivery to partner Heineken in  
Amsterdam far exceeded all  
expectations (Photo: Lenze Schmidhauser)



The year 2025 is to mark the end of air-pollution caused by high-emission vehicles in Amsterdam's inner city traffic. The city administration is mainly focusing on city buses, trucks, and vans. Even today vehicles that are too loud or emit too much pollution are mostly barred from the center – with the exception of a narrow time slot for deliveries. The ambitious project is already showing initial signs of success. Currently more than 20 electrically driven trucks can be seen on the streets around the center of the Dutch capital. One already drives for Heineken. The Dutch brewery is in the process of switching its beer trucks over to electric. The trucks are supplied by Dutch vehicle maker Ginaf, which has opted for the Mobile system by Lenze Mobile Drives for the technology inside. The compact combined devices, consisting of inverters and DC-DC converters, drive two auxiliary units and provide the on-board power supply.

While discussions are still afoot elsewhere, in the Netherlands electric vehicles are fast becoming part of daily life, especially in Amsterdam, which is taking the lead. This is reflected in the growing number of electric

vehicle registrations and dense network of charging stations. The target is 4000 by 2018. The Dutch capital is forging ahead with electric mobility through funding schemes and regulations, ably supported by the corporate world. The Heineken brewery has been delivering beer to inner city customers with a fully electric vehicle since November 2014. It was designed and retrofitted by another Dutch company, truck builder Ginaf. The company refitted a standard Mercedes Benz truck for Heineken: an electric drive of around 400 HP drive replaces the diesel engine and a lithium-ion battery is used instead of a fuel tank. It consists of 188 series-connected cells, each with a voltage of 3,2 V – or approximately 600 V in total.

## One inverter for two units

Ginaf uses a combination of inverter and converter, type DCU/PSU 30/5.6 by Lenze Schmidhauser. A mobile dual solution, the inverter converts the 600 V<sub>DC</sub> into three-phase AC with a peak output of 30 kW – thus driving the motor with a dual clamp for two auxiliary units: the hydraulic unit to ▶

support power steering and the pneumatic pump for air pressure. While the hydraulic unit runs continuously to support the power steering, the compressor is only activated over an electromagnetic coupling if the system pressure drops. As the compressor in particular is only actuated on demand, Ginaf thus reduces energy consumption. In addition, the Lenze Schmidhauser DC-DC converter with 200 A and an output of more than 5,6 kW provides the entire on-board power supply. The energy-efficient operation of the auxiliary units and on-board power supply bring a crucial advantage: increased range. Ginaf specifies up to 200 km. Heineken's drivers by no means take this performance to the limit, they cover merely 50 km to 60 km on their daily tours.

These comparatively short distances are due to the general logistics concept of only going all-electric for the famous 'last kilometer' from the logistics warehouse on the outskirts of the city. So the aim is not to cover long distances, but to increase delivery flexibility with the electrically driven truck. As Amsterdam's city administration only permits truck deliveries to city stores and restaurants between seven and eleven in the morning, Heineken's logistics partner is left with a time slot of just four hours – which means more drivers and tours, because the city center is only accessible for half the day.

As these restrictions do not apply to electrically driven trucks, more tours per day are possible. A crucial factor in ROI calculations, especially as the Ginaf vehicle costs twice as much as a conventional truck with a diesel engine. According to the company's CEO André Molengraaf the drive concept means that the fleet has fewer vehicles as more tours can be completed per day. Moreover, delivery and service availability are improved to the satisfaction of customers. As Molengraaf sums up: "Cost per kilometer thus accounts for just a fraction of the supply chain expenses – especially when you take wage costs into account".

The drivers are also very happy with the vehicle – even if the electric drive demands a completely different driving style because only one pedal is effectively used for acceleration and braking. The vehicle's ergonomics and quietness in the driver's cabin' are often praised, says the company. Many drivers in conventional trucks complain about the absence of ear protectors. In view of the good experience, further electrically driven trucks are to replace Heineken's diesel fleet within its distribution operations: eight are to follow in Amsterdam and Rotterdam in 2016. Truck builder Ginaf in turn aims to establish electric drive technology in trucks with higher payloads. Here the key emphasis is on the use of established technology on a modular basis with standardized interfaces and untapped output potential.

These aspects played a decisive role in the selection of a system partner. "We were looking for a manufacturer capable of converting 600 V into three phase AC with a rugged modular system and the appropriate interfaces", recalls Dirk Inia, software developer at Ginaf. Components can only be integrated into a truck's existing network with a sufficient number of appropriate interfaces on board. Despite the conversion of the diesel engine to an electric solution, the full 24 V on-board power supply is retained for

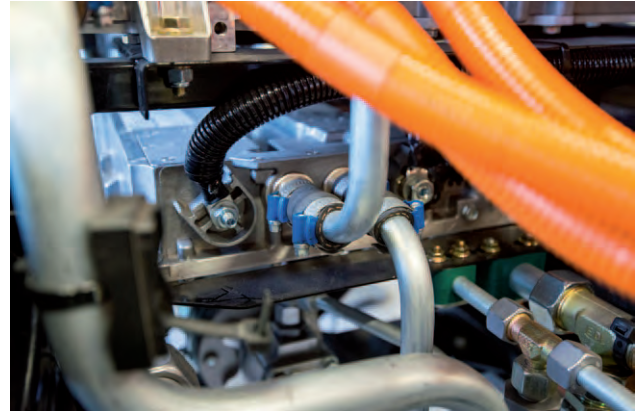

Figure 2: The DCU/PSU inverter-converter unit is equipped with water cooling for increased power density (Photo: Lenze Schmidhauser)



Figure 3: The author of this article, Jonas Schuster talking to Dirk Inia and André Molengraaf (left to right) (Photo: Lenze Schmidhauser)

all consumers. So the powertrain must be as easy to integrate as possible. Lenze Schmidhauser's Mobile system therefore offers PublicCAN communication with the CAN J1939 protocol as standard – it is the standard bus in the automotive industry. And all the different solutions use the same housing, which also saves space for integration into vehicles as they are stacked. No matter whether inverters, DC-DC converters or a combination of the two are used: the engineering software for Mobile parameter setting is always the same, saving software developers like Dirk Inia a lot of time on engineering as only one tool is used. In addition, projects can be recycled for future assignments. André Molengraaf concludes: "quality and safety are what matter to us" and is pleased that Heineken's expectations of the first vehicle were exceeded by far. ◀



#### Author

Jonas Schuster  
 Lenze Schmidhauser  
[jonas.schuster@lenze-schmidhauser.ch](mailto:jonas.schuster@lenze-schmidhauser.ch)  
[www.lenze.com](http://www.lenze.com)

# Automotive Ethernet for mobile machines

The CAN network is the predominant communication technology in the mobile sector, from cars to fully automated harvesters. The growing demand for bandwidth requires upgrades with complementary communication technologies.

The increasing level of automation, even of safety-relevant functions, highlights other necessities such as functional safety, hard real-time behavior, and expanded diagnostic capabilities. In the area of mobile machines, these limitations are overcome by technology transfers from industrial automation and the automotive industry.

In this article, we look at the suitability of automotive Ethernet for the area of mobile work machines. The essential parameters of this investigation are the degree of standardization, technological maturity, achievable data throughput, real-time behavior and functional safety in mixed-criticality networks. With regard to their potential and their options, the most important technological innovations such as OABR, time-sensitive networking and Deterministic Ethernet are compared with alternative approaches from industrial automation such as Ethercat or Powerlink, as well as with a further development from the automotive industry, CAN FD. Furthermore, existing limitations and possible effects of automotive Ethernet in the agricultural sector are analyzed: which adjustments to the currently used network topologies are necessary, how can automotive Ethernet be integrated into existing architectures as an extension of CAN networks, and how can typical functions of agricultural machines benefit from the new standards?

## Growing demands on modern bus systems

In modern agricultural machines like tractors or fully automated harvesters, numerous CAN networks, such as an engine CAN or vehicle CAN, are used in order to enable communication within the control system. For this purpose – depending on the application – the CAN-based Isobus

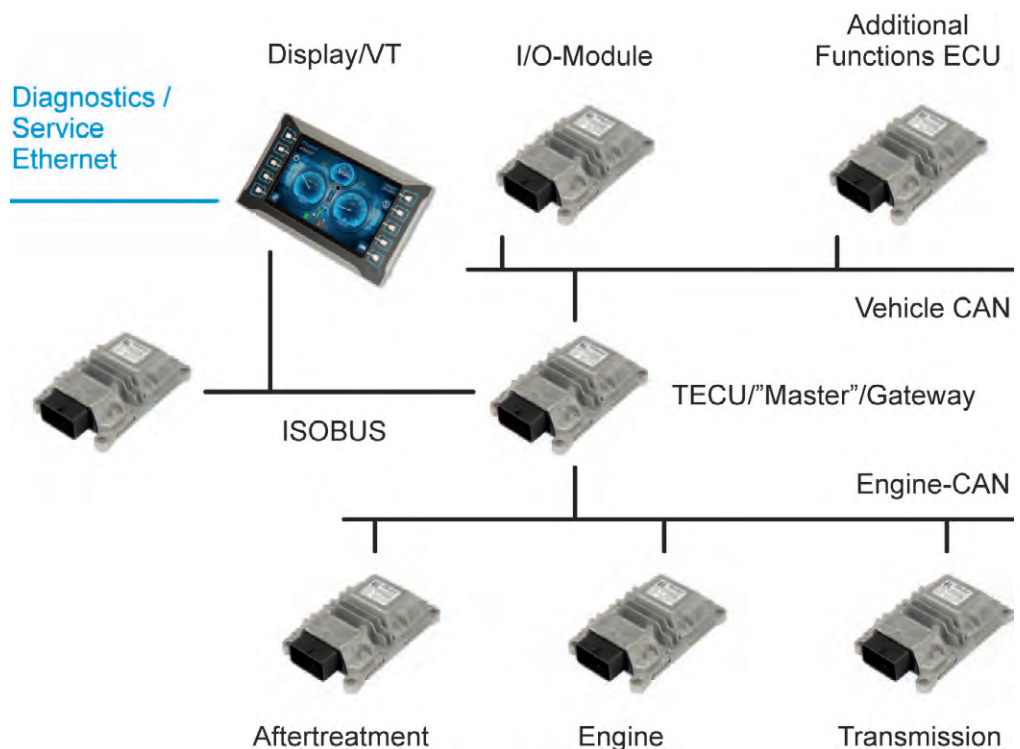

Figure 1: Schematic network of a tractor (Photo: TTControl)

(ISO 11783) is additionally used in order to allow communication with implements such as trailers. SAE J1939 is often used as a basic protocol for these CAN networks, which specifies a bit-rate of 250 kbit/s. In communication with HMIs as well as fleet management and diagnostic systems, Ethernet is already used today, often with the classic physical layer 100 Base-TX.

The bandwidth requirements of new technologies, such as the continuously increasing resolution of displays, IP cameras (in some cases with surround view functionality), sophisticated fleet management systems using technologies from the IoT/Industry 4.0 world, as well as increasing automation of machine functions, exceed the available bandwidth by orders of magnitude. A single IP camera causes a data throughput in the range of 10 Mbit/s. A modern CAN-based system which includes complex gateways often has an overall bandwidth of approximately 1 Mbit/s to 2 Mbit/s, whilst future technologies will cause a data volume that is up to three orders of magnitude bigger than currently available.

Several of these functions, especially the automation functions in the area of drive, steering and working functions, also set strict requirements of functional safety, ▷

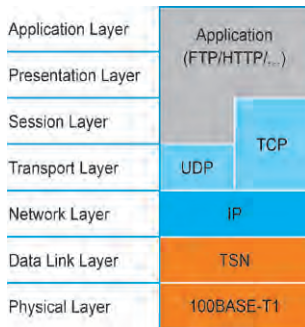

Figure 2: Automotive Ethernet (in orange) in the OSI reference model (Photo: TTCControl)

security and real-time capability. These three points particularly come to the fore if automation functions have to share the physical communication medium with other services, for example a steer-by-wire system that shares a network with the diagnosis system having cloud access. In this case, it must be ensured that in the event of problems in the diagnosis system, the automation function continues to have guaranteed bandwidth and latencies, so that the steering continues to work reliably and safely, despite an unwanted network load created by the diagnosis system.

Each possible solution has to increase the bandwidth by an order of magnitude, i.e. make bandwidths of at least 10 Mbit/s to ideally 1000 Mbit/s available. With a dynamic, time-limited bandwidth increase, CAN FD, significantly improves the throughput of Classical CAN by up to 12 Mbit/s (with currently available CAN transceivers) and a larger payload. It also offers a clear migration path from

### Possible solutions

existing systems to higher bandwidths thanks to the technology relating to Classical CAN. However, with the achievable average bandwidth of 5 Mbit/s, CAN FD is not always suitable for IoT/Industry 4.0 or image-based applications such as surround view.

A further option is the integration of an established industrial Ethernet variant such as Ethercat, Profinet, Powerlink or Ethernet/IP. Each of these has its own application-specific advantages and disadvantages and is bound to the respective manufacturer that has developed this communication technology to varying degrees. These are based on Ethernet and, depending on the protocol, they access the Ethernet stack at various levels. Ethercat for example, already accesses layer 2 (data link layer) in the Ethernet protocol, whilst on the other hand, Powerlink, only accesses layer 3 (network layer). All of these protocols support a data rate of at least 100 Mbit/s.

A further solution could be completely based on Ethernet-standardized mechanisms of the IEEE. Ethernet-based solutions offer many advantages. Ethernet is widespread, standardized, and many products, technologies, and tools are already based on Ethernet. However, implementing a solution originally developed for use in an office environment in the area of mobile machines poses many challenges: they range from cabling and plug technology to functional safety, from determinism to integration into existing systems. In these areas, several current core developments solve these problems in the long term such as new physical layers suitable for automotive or deterministic >

# CAN Products for your requirements



CPC-USB/ARM7



EtherCAN CI-ARM9

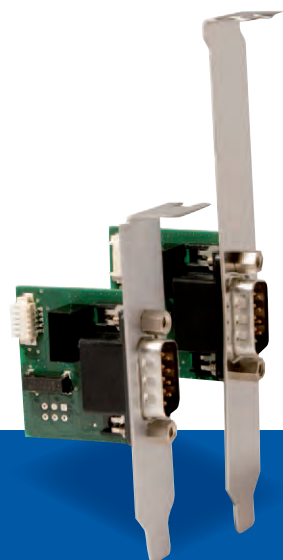

CPC-USB/embedded

- Economical solutions for series applications
- Optimized for industrial applications
- Solutions for stationary and mobile use
- Software support for bus-analysis, measurement and control



Sonnenhang 3  
D-85304 Immünster  
Tel.: +49-8441-49 02 60  
Fax: +49-8441-8 18 60  
[www.ems-wuensche.com](http://www.ems-wuensche.com)

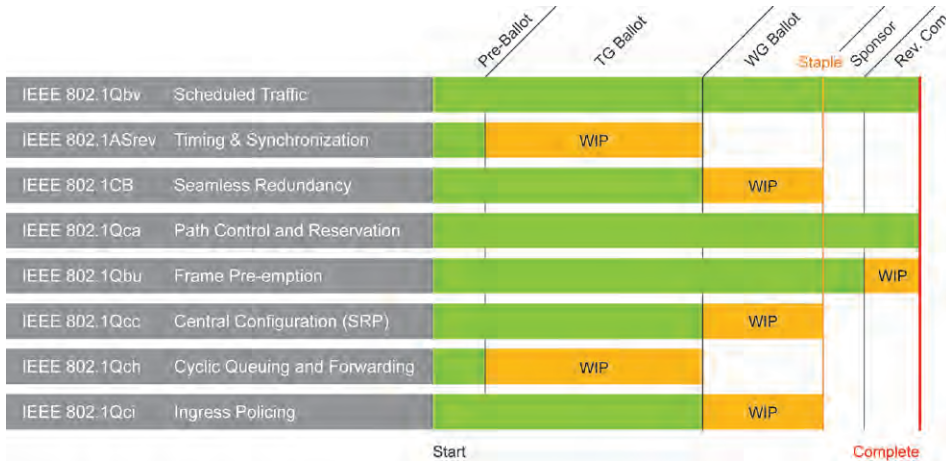

Figure 3: Status of TSN-standardization as of March 2016 (Photo: TTCControl)

Ethernet expansions. The combination of these technologies is described in this article as "automotive Ethernet".

### Physical layer – layer 1

100Base-T1 (formerly OABR – Open Alliance BroadR-Reach) is a PHY primarily developed for the automotive market that achieves a bandwidth of 100 Mbit/s via a simple UTP (unshielded twisted pair) cable. This development originally came from Broad Com, was later made a de facto standard for automotive Ethernet by the Open Alliance BroadR-Reach as an interest group, and finally standardized directly by IEEE as 100Base-T1. This PHY is already used in car production programs and is also considered a favorite for future Ethernet uses for a variety of applications in the mobile sector, such as the "high-speed Isobus".

### Data link layer – layer 2

IEEE is working on the expansion of the IEEE 802 standard in order to offer real-time capabilities for applications in the automation and automotive sector. These activities are based on significant preparations for AVB (Audio Video Bridging) and predominantly intervene in layer 2. The group of Time-Sensitive Networking standards (TSN) offers features such as traffic shaping, bandwidth guarantees, and deterministic messages with guaranteed latency and redundancy mechanisms. These Ethernet features can access various protocols on a higher level, such as UDP, but also be combined with established industry protocols that only access layer 3 (network layer). With TSN, automation applications that require hard real-time and functional safety, video signals that require a guaranteed bandwidth, and service or diagnosis data that can create a very inter-deterministic network load can be converged on one single Ethernet network.

As TSN is very broadly defined and offers differing mechanisms, users should create a "profile" suitable to them, in which they only

use those features that they actually need in order to keep the complexity to a minimum. For a simple video signal, time stamping and VLANs are sufficient, for safety-critical controllers a full deterministic Ethernet with an error-tolerant time synchronization and redundant paths is preferable. It could even be expanded with further extensions such as SAE AS6802 or similar mechanisms with microsecond-jitter. TSN describes a collection of standards that are prepared by the IEEE Standards Association in the LAN/MAN Standards Committee in the Working Group IEEE802.1 TSN. Figure 3 shows the status of standardization.

### Limitations and future expansions

Even though 100Base-T1 and the TSN standards offer a solid basis to complement CAN in future communication architectures of mobile machinery, several improvements are still possible. It can be predicted today, for example, that 100 Mbit/s will not be sufficient for all applications, especially those with environment recognition and image processing. With 1000 Base-T1, a gigabit variant of the Single-Pair Unshielded Twisted Pair-PHY was already signed off by IEEE on June 20, 2016 [1].

The limitation of the cabling length to 15 m at USP is also relevant for mobile machines. Whilst this does not present a serious limitation in a car, it can cause problems in large mobile machines or networks that are operated between a tractor and trailer, for example. Currently, it is only possible to work with extra switches or STP (up to 40 m) [2] in order to overcome these limitations.

A further development that may be of interest to the mobile machinery sector is offered by IEEE P802.3bu (1-Pair Power over Data Lines – PoDL): sensors, cameras, or controls consuming little power can be directly supplied via the UTP communication cabling. This standard is to be signed off by the IEEE at the beginning of 2017 and can lead to further optimization in the cabling of sensors and cameras.

100(0)Base-T1 and TSN offers a solid foundation (layer 1-2) for Ethernet-based communication, however, over the next few months and years it has to be



Figure 4: TTCControl's CAN/Ethernet gateway as an integration element in existing architectures (Photo: TTCControl)

decided sector-specifically how the higher layers can be designed. In the area of mobile machines, this can happen with simple UDP-based proprietary protocols for smaller machines or by borrowing from industrial automation such as the integration of existing fieldbus protocols or concepts such as OPC UA. The automotive sector will also offer options for major manufacturers with Autosar, DoIP, or Some IP.

### Integration into existing architectures

The integration of automotive Ethernet is likely to happen via various channels. On the one hand, there are corresponding activities in groups, such as the "High-Speed Isobus" project team in the AEF [3], in which cross-manufacturer interfaces are being defined. On the other hand, parts of local networks in a machine can be gradually con-

verted to Ethernet. Due to the large bandwidth, CAN/Ethernet gateways, like the ones offered by TTControl, can be more easily realized and even become an advantage for diagnosis and maintenance, as the entire CAN traffic can be accessed with a single Ethernet-based diagnostic connector and safety mechanisms (in terms of "security") can be integrated at a central point. This means a corresponding 100Base-TX/TSN deterministic Ethernet switch that also offers numerous CAN channels can take over the necessary Ethernet switch role in the network, but can also be a 100Base-TX/100-Base-T1 media converter and realize CAN/Ethernet gateway functions in order to integrate existing CAN and new Ethernet networks. ◀

### References

- [1] <http://www.ieee802.org/3/bp/>
- [2] [https://standards.ieee.org/events/automotive/2015/01\\_IEEE\\_Standards\\_for\\_Automotive\\_Networking.pdf](https://standards.ieee.org/events/automotive/2015/01_IEEE_Standards_for_Automotive_Networking.pdf)
- [3] <http://www.aef-online.org/en/aef-projects/the-project-teams.html>

### Author

Janosch Fauster  
TTControl  
[janosch.fauster@ttcontrol.com](mailto:janosch.fauster@ttcontrol.com)  
[www.ttcontrol.com](http://www.ttcontrol.com)



## CAN Products for your requirements



Optical Fiber  
Transceiver



CAN FiberOptic  
Router



CAN FiberOptic  
Router

- Optical fiber connection of copper networks
- CAN network extension up to 40 km
- EMI insensitivity
- Customer specific variations possible



Sonnenhang 3  
D-85304 Immünster  
Tel.: +49-8441-49 02 60  
Fax: +49-8441-8 18 60  
[www.ems-wuensche.com](http://www.ems-wuensche.com)

# Data on wheels and in the cloud

*Trucks have become mobile data centers. Their CAN in-vehicle networks are things in the Internet, when they are linked to the IT world. B-Plus is setting the data course to bring fleet management to the driver cabin.*

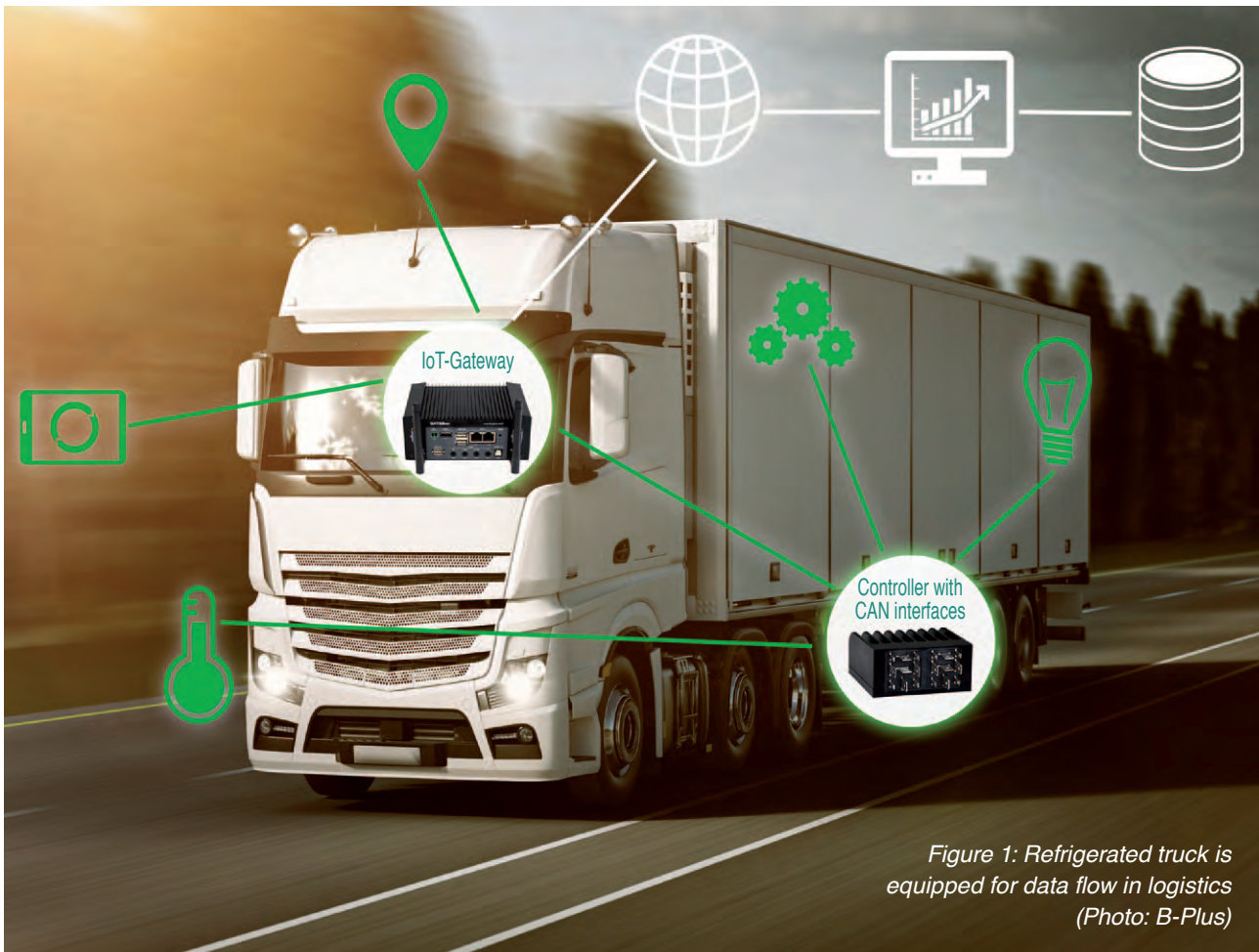

*Figure 1: Refrigerated truck is equipped for data flow in logistics  
(Photo: B-Plus)*

If the focus is increasingly on digitalization in road logistics, the hardware bundling, sorting, and transmitting information bears an important responsibility. It is necessary to bring fleet management to the driver cabin and the data regarding the vehicle configuration to the head office.

The freight traffic industry has linked itself to the data traffic: time pressure and intense traffic have digitalized logistics in the age of the Internet of Things (IoT). And that's just the start as the future of mobility offers further data-based visions whose possibilities are nowhere near exhausted. In the future, the completely networked truck shall represent a redefinition of transport making road transport more efficient for drivers, freight forwarders, vehicle manufacturers, and the whole of society.

According to Daimler, around half a billion euros shall be invested in online technology until 2020 in order to link trucks among each other or with the infrastructure. This

is to reduce incorrect deliveries, empty trips, and planning difficulties. In the course of increasing density of the road freight transport, an optimal use of a truck can only be achieved by a highly effective connectivity as well as transparent and up-to-date data.

For data management, telematic systems, and networked trucks need platforms and devices supporting this communication and taking responsibility for it. The example of temperature-controlled transportation vehicles illustrates the scenario: as for quality control, the cooling chain of the cargo must not be interrupted and shall be documented. Fleet and order administration can be optimized by a fusion of logistics and digitalization. Connection with the ERP system provides information about the order situation and route. For security reasons, in transportation, a theft prevention system as well as GPS monitoring and a door safety mechanism have to be provided. ▶



## Robust controllers for body builders

B-Plus offers suitable devices and system solutions meeting the more and more complex requirements of specialized equipment control in utility vehicles. The b-CANCubeMini robust compact controller allows onboard control of e.g. the data on a monitoring function. Bus interfaces to the truck and I/Os for sensors and actuators as well as communication with the IoT Gateway via CAN are the responsibility of this flexibly adaptable controller.

For local data storage as well as Edge Analytics in connection with the Internet, the Gatebox gateway can be added. One of the strengths is to combine the two product ranges to one "Online Automation System" which provides, from the point of view of the driver, advantages towards the head office and towards the truck body.

Utility vehicles are subject to unfavorable factors such as temperature changes, dust, and vibrations. This requires extremely robust mobile controllers that detect various parameters of the device, take over control functions and simplify many processes in the utility vehicle.

The b-CANCubeMini multi-functional compact controller has been tested in practice, e.g. for the reading-out of door sensors, monitoring of temperature sensors, and control of the cargo hold lighting. This device acts as a gateway to the vehicle via the CAN-based J1939 interface of the bodybuilder control device. Thus, warnings indicating an open door or a too low temperature can be displayed in the original instrument cluster of the truck and lighting can be controlled e.g. from the cockpit. The high-current carrying capacity of the outputs allows a direct control of the cargo hold lighting. The outputs can be charged with up to 4 A. The individual outputs can be individually parameterized.

The two CAN interfaces provided on the b-CAN-CubeMini can be used for connection to the IoT gateway as well as for communication with further CAN-connectable devices on the vehicle body network or for communication with the truck or industrial engines. The control device based on a 32-bit micro-controller comes with C-libraries for various trucks and industrial engines.

## Smart gateways for IoT applications

Gateways provide connectivity. Such devices link the commercial vehicle to the infrastructure and ensures the data flow between the device and the cloud. As a flexible platform for IoT applications, the Gatebox 100 performs the Fog Computing. Furthermore, it locally stores operational data, thus, not requiring a permanent access to the Internet. In addition to this "operational data logger" function, the gateway takes on Edge Analytics features allowing an analysis directly on the vehicle, wherein errors are pre-analyzed and reported to the head office. This function is implemented in an industrial computer, in order to defy all challenges of outdoor use maintenance-free. The temperature tolerance up to -40°C ensures reliable operation even at extreme operating temperatures as e.g. required by an overnight outside vehicle fleet. In order to meet the special requirements of industrial outdoor use, ▷

# Industrial Ethernet Gateways / Bridges

CAN / CANopen  
EtherCAT  
PROFINET



CANopen

PROFINET

EtherCAT

### CAN-EtherCAT

- Gateway between CAN/CANopen and EtherCAT
- Additional Ethernet interface for EoE

### CANopen-PN

- Gateway between PROFINET-IO and CANopen
- PROFINET-IRT capable
- Simple configuration via S7 manager or TIA portal

### ECX-EC

- EtherCAT slave bridge
- Process data exchange between two independent EtherCAT networks
- DC synchronization between EtherCAT masters

 **embeddedworld2017**  
Exhibition & Conference  
... it's a smarter world

Hall 3A, booth 221  
in Nuremberg 14.-16.03.2017

 **HANNOVER  
MESSE**

Hall 9, booth F17  
24.-28.04.2017



esd gmbh  
Vahrenwalder Str. 207  
30165 Hannover  
Germany  
Tel.: +49-511-3 72 98-0  
info@esd.eu  
www.esd.eu

US office:  
esd electronics, Inc.  
70 Federal Street - Suite #2  
Greenfield, MA 01301  
Phone: 413-772-3170  
us-sales@esd-electronics.com  
www.esd-electronics.us

www.esd.eu



Figure 2: The b-CANCubeMini control unit is suitable for vehicle body applications (Photo: B-Plus)

a 24-hours, 7-days running device has been provided. Therefore, the industrial computer does not have a cooling fan nor a battery and no moving parts. Instead, the use of passive cooling, Supercaps and SSDs ensure reliable operation, thus reducing operating and service costs of the gateway.

In order to interconnect the data with the cloud, the gateway offers WWAN, WLAN, or LTE as well as CAN interfaces or digital I/Os for interconnection with sensors and mobile controllers. The modularly configured industrial computer has a size of 15 cm in width, 5,8 cm in height, and 9,5 cm in depth. The standard version offers two Gigabit-Ethernet interfaces, so that two physically separated networks for firewall applications can be implemented. Furthermore, the standard version includes two USB 2.0 ports, one HDMI connector as well as four 9-pin D-sub connectors, which can be used for CAN, EIA 232, or EIA 485 interfaces.

For customer-specific adaptations, the gateway has a specifically flexible Smart I/O Driver Interface (SIODI) shield. This concept allows integration of further interfaces. No matter if analog or digital I/O ports, serial bus systems such as CAN, audio or customized I/O cards are concerned, customers will find pre-defined options scalable as to their variety of interfaces and CPU performance.

By means of this gateway, also the status of other devices in addition to a connection to the cloud can be monitored. It is for example able to initiate a restart or an update without being on location. For collecting data, a customized complete solution is required including an IoT framework, which can, subsequently, also take on analysis and long-term documentation. This framework also allows a direct transmission of orders to the vehicle by using CAN or general purpose I/O ports. It supports administration,

up-dating, addressing, or configuration of nodes. The gateway can be integrated into an existing IoT framework and delivers available data to the complete system.

Summarizing, B-Plus offers a flexible portfolio for specific data supply in trucks, which is based on tested devices that have proven their practical suitability in various applications. The right view to industrial requirements in combination with applicable solutions is based on sound knowledge of embedded computing. Proceeding on the basis of this technical competence, there is a wide field of application in automotive and mobile automation. ◀



Figure 3: The Gatebox 100 LTE gateway links the in-vehicle networks to the cloud (Photo: B-Plus)



**Author**

Dipl. Ing. Adrian Bertl  
 B-Plus  
[adrian.bertl@b-plus.com](mailto:adrian.bertl@b-plus.com)  
[www.b-plus.com](http://www.b-plus.com)

## CiA publications



### CAN Newsletter magazine

- ▶ News and reports
- ▶ Technology oriented articles and background information
- ▶ Detailed application stories

### CiA Product Guides [www.can-productguides.org](http://www.can-productguides.org)

- ▶ Highly integrated into the new CAN Newsletter Online
- ▶ Advertise CANopen, CAN, and J1939 products
- ▶ Dedicated features, standardized and edited entries
- ▶ Find worldwide contact data for each company

### CiA's Weekly Telegraph

- ▶ Always be up to date
- ▶ Please subscribe to CiA's Weekly Telegraph

### CAN Newsletter Online [www.can-newsletter.org](http://www.can-newsletter.org)

- ▶ Product and service news
- ▶ Brief application reports
- ▶ Dossiers and features
- ▶ Background information

For more details please contact CiA office  
at [headquarters@can-cia.org](mailto:headquarters@can-cia.org)

[www.can-cia.org](http://www.can-cia.org)

# CANopen interface for vacuum pump

*This is an old and with each project returning question. You can integrate the interface in your device's MCU, develop an add-on module, or buy such a module.*



(Photo: Coval)

Equipping your product with communication interfaces requires a fast analysis of market targets for developed equipment. Today there are many network protocols and it is often necessary to be compatible with many of them in the simplest way possible. This can be achieved in different ways depending on the technical and financial criteria. Solutions are either to develop an additional “communication board”, buy such a board from specialized manufacturers or build a device with a processor, which is also able to communicate on the selected communication technology in addition to process management.

The last solution, even if processor usually limits application complexity, has anyway some advantages and can be used for different reason:

- ◆ Using just one processor with on-chip network controller can dramatically reduce the PCB (printed circuit board) footprint. This approach doesn't require any additional hardware except a transceiver chip.
- ◆ The form factor criteria is totally controlled.
- ◆ The BOM cost is optimized and customs hardware interfaces may be implemented, like analog or digital I/O's.
- ◆ Optimum performances corresponding to device's features may be achieved by selecting the right processor
- ◆ The communication part of embedded software is the only software part that changes depending on desired network technology.

Coval decided to equip its Lemcom vacuum pump with an embedded CANopen interface using the already existing hardware resources of the product. For the design of the network interface, the company cooperated closely with Isit. The Lemcon is the first vacuum pump with CANopen connectivity.

The vacuum pump is based on an innovative, efficient product structure based on a CANopen coupler and additional vacuum secondary pumps. The master pump module has the responsibility to manage the CANopen communication, the communication with the secondary pumps, and its own fully-integrated vacuum pump. The two CANopen connectors enable a continuous network chaining. The secondary pumps are connected to the master pump via the Coval bus.

Contact between the master pump and the secondary pumps is confirmed by an M8 connecting bridge for island configurations or by an M8/M8 cable for configurations based on remote modules. ▶



Figure 1: The modular Lemcom vacuum pump with embedded CANopen interface (Photo: Isit)

Based on an ARM (Cortex M3) processor by Renesas, the master pump module has enough power to handle at the same time CANopen communication, internal vacuum regulation, and also the internal bus for the secondary pumps. It also acts as a gateway for updating the secondary pump's firmware. The processor runs the CANopen protocol stack providing SDO segmented and block transfer, PDOs transmitted synchronously and change-of-state, as well as Heartbeat functionality. The product uses a proprietary device profile and a proprietary PDO mapping. All vacuum pump configuration parameters are represented in the CANopen object dictionary and can be written by means of SDO services. The CANopen software also features a "safe" boot-loader with SDO block transfer. The EDS (electronic data sheet) file coming with the product eases the integration in host controllers, e.g. PLCs (Programmable Logic Controller). The Lemcom pump with CANopen connectivity has been awarded with the French trophy "Cap' Tronic 2015". The product has been tested successfully on CANopen conformity by CAN in Automation.

The secondary pumps are equipped with ARM (Cortex M3) processors by NXP. The source code versions in the master as well as the secondary pumps are managed by means of the SVN tool, and bugs are managed by means of the Jira tool.

Coval, since 30 years, set out to provide their clients and users with vacuum handling solutions that meet their goals in terms of profitability, productivity, quality, safety, and environmental conservation. The company addresses several markets and industries: food processing, aeronautics, robotics, plastic processing, packaging, and more. Due to continuing its export development, the French supplier is now acknowledged at European level in the domain of vacuum management. The pump manufacturer offers CANopen protocol trainings for its customers.

Isit, founded in 1991 and now part of ICE Group since 2015, has built its success on a strong customers commitment based on a full service approach, technology and methods assistance and the ability of providing customized turnkey solutions. The service provider leverages long term relationship with its suppliers and

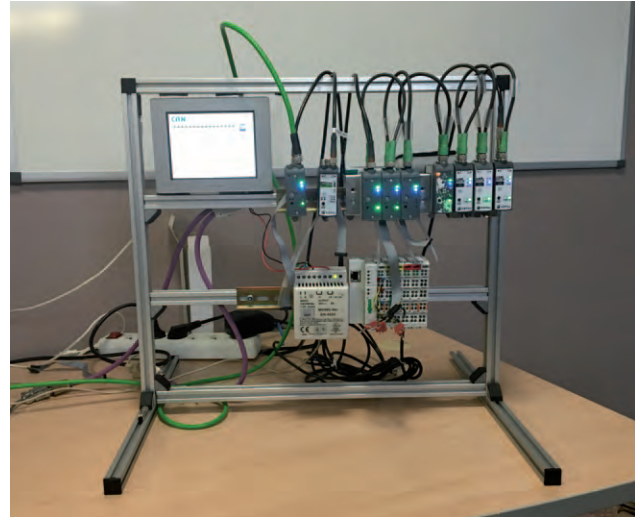

Figure 2: System set-up of the Lemcom vacuum pump in the laboratory (Photo: Isit)

partners (silicon and software vendors, integrators and contractors) and over the years, has developed strong skills in functional safety, security, and industrial communication systems especially in embedded real-time systems. For 15 years, the French company has participated in numerous projects integrating the CANopen protocol at all levels, be it for training, software integration, consulting, audit, or expertise. ◀

**“ The Lemcom is the result of an excellent collaboration between Isit and Coval in both technical and relational terms. The support and technical expertise of Isit have been continuous from the specifications to the certification and deployment phases for our customers. Undeniably a successful partnership!**

**Johan Chevallier,  
Coval's Embedded Products Manager**

#### Author



Franck Montagne  
Maurice Lauze  
Isit  
[fmontagne@isit.fr](mailto:fmontagne@isit.fr)  
[mlauze@isit.fr](mailto:mlauze@isit.fr)  
[www.isit.fr](http://www.isit.fr)

## Wire it up with CANopen

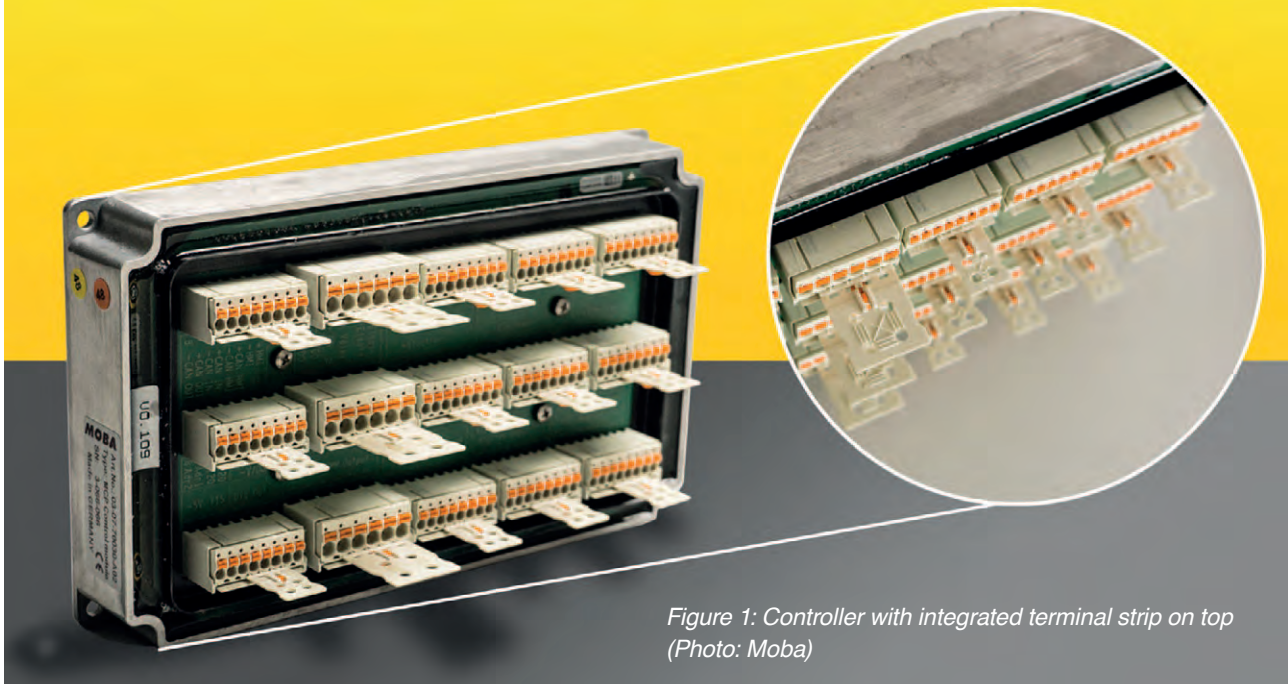

Figure 1: Controller with integrated terminal strip on top  
(Photo: Moba)

*To reduce cabling effort, Moba developed a controller that contains an integrated terminal strip on top. OEMs are now able to wire their machines directly to the top of the controller.*

There is one major challenge in installing a mobile controller into a cabinet: Usually, the controller and the terminal strip are placed right next to each other, wired via the controller's plug. This causes quite some cable work. However, for convenience reasons and most importantly for increased service-friendliness, there must be another solution. Moba thus has developed a controller that contains an integrated terminal strip on top (Figure 1). The necessary supplies are available at the inputs and outputs. OEMs are now able to wire their machines directly to the top of the controller. If a controller needs to be maintained or changed, one can simply disconnect the plugs and unwire the controller within minutes. This does not only save a significant amount of cable but also supports an easy exchange. Both, the machine manufacturer's service team and the customer thus save considerable time.

The time-saving benefit is only one aspect that convinced [Ruthmann](#), manufacturer of truck-mounted working platforms, to use the Modular Control Panel MCP for their Steiger-series and models called 'Cockpit'. The integrated cabinet contains the mentioned controllers with a time-efficiently removable plug and clamp combination on top (Figure 2). The concept of structuring and optimizing the installation of the mobile controller is just another measure to guarantee an uncomplicated and time-efficient replacement. It complements the numerous additional developments within the scope of the modular concept that increase service-friendliness, such as a patented contactless joystick.

The MCP allows a variety of combinations of components, such as keypad, joystick and display modules. Furthermore, two gateway controllers are integrated to get a redundancy of the I/O's if needed. In the case of two controllers, the left controller is key element and operates as a gateway of the internal Moba bus to the external machine bus. Also, the left controller administers all Moba components through CANopen, CiA 301 Version 4.02. Both controllers are integrated into the machine bus and communicate via the CANopen protocol. This facilitates an easy integration of the control panel into the machine of any manufacturer. Figure 3 demonstrates the CAN communication of Ruthmann's 'Cockpit', an exemplary MCP with two controllers, two joystick modules, one keypad module, and one display module.

CANopen devices of the same bus must clearly be identifiable with their node number. Since there are MCP variants with two controllers, the controllers must somehow be addressable from the outside. For this reason, two analog pins were added to the hardware of the controller, to be able to influence the node number. The analog pins can have three states (open, high, and low), which enables  $3^2 = 9$  different node numbers. All addressings of the controller are displayed in Table 1.

Furthermore, the Moba components obtain electricity through the connection board of the gateway controller. This connection can be operated via the software. By this means, an individual reset of the panel is possible without ▶

Table 1: All addressings of the controller in dependence of the analog pin (Photo: Moba)

Controller	Analog Pin 1	Analog Pin 2	Node number	Bitrate in kbit/s
Left controller	Open	Open	0x32	125
Right controller	Low	Open	0x3C	125
Left controller	Open	Low	0x33	125
Right controller	Low	Low	0x3D	125
Left controller	High	Open	0x32	250
Right controller	High	Low	0x3C	250
Left controller	Low	High	0x33	250
Right controller	High	High	0x3D	250

having to reset the whole machine. This is beneficial for e.g. an exchange of the joysticks. They can be exchanged without disassembling the whole panel. For a subsequent new initialization of the joysticks, a voltage reset is necessary, easily carried out by a controller reset. This works either with a key combination or the object directory. Another special feature is the joystick configuration. It is a well-known problem that each machine has another control, depending on the manufacturer. For operators it thus is a challenge to adapt to the control every time a new machine needs to be operated, especially when renting an aerial working platform. For this reason, the micro-controller has a setting that allows to change the logic of the joystick signals. These signals are correspondingly forwarded to the machine control.

### Controller features

Beside its function as the administrator of several Moba components, the controller can be used as a plain I/O device. It has 16 digital and 8 analog inputs. The switching level of the digital inputs is dependent on the present operating voltage and switches at 0,65  $U_b$  to 0,75  $U_b$ , while  $U_b$  is the operating voltage. The digital inputs can be configured as NPN or PNP input through transistors, which are connected to the micro-controller. For the user, it thus is possible to individually configure each digital input with the CANopen object directory. The evaluated digital inputs are subsequently sent via defined PDOs. Three of the digital inputs can optionally be used as a frequency input. The ▶

This adjustment option is called 'joystick permutation'. It can be carried out with a key combination or via the CANopen object directory. In total, there are 384 different joystick permutations based on two joysticks. So far, there have been implemented 192 into the controller. The other 192, however, can be implemented anytime if necessary.



Visit us in Las Vegas:  
March, 07 - 11, 2017  
IFPE - South Hall 3, S81516

Las Vegas Convention Center  
3150 Paradise Rd  
Las Vegas, NV, USA



## CANlink® wireless

### Economic Wireless CAN Communication via Bluetooth and WLAN

#### AS A WIRELESS GATEWAY

Multi-functional interface for various applications.

#### CAN-BRIDGE FUNCTION

Connect CAN networks wirelessly.

#### AS A SERVICE INTERFACE

Use our dashboard software to display data individually on a computer, smartphone or tablet.

#### COMPACT AND ROBUST

Low-cost wireless CAN interface in a compact housing for easy assembly.



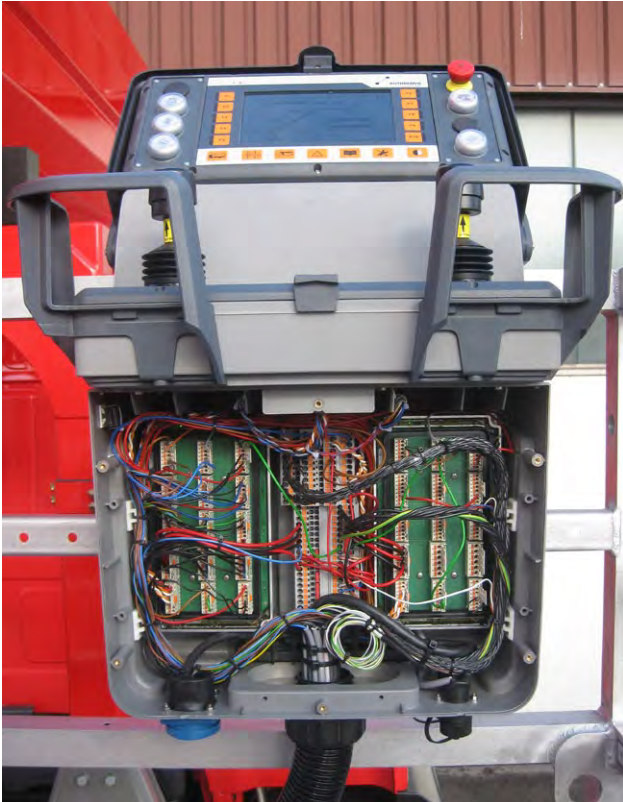

Figure 2: Wiring of the two controllers of Ruthmann's Cockpit (Photo: Moba)

user thus has the possibility to measure a frequency range of 0 kHz to 30 kHz with an accuracy of  $\pm 0,2\%$ . The analog inputs contain the operating modes 0 V to 5 V voltage input, 0 V to 10 V voltage input, 0 mA to 20 mA current input, or 4 mA to 20 mA current input.

Similar to the configuration of the digital inputs, each analog input can individually be configured via the CANopen object directory (index 2015<sub>n</sub>). During the conversion from analog to digital, the micro-controller has a resolution of 12 bit. For the accuracy to be at least  $\pm 1\%$  FS (Full-scale), each analog input is calibrated by the in-house test

system. The calibrated values are subsequently saved into the EEPROM, which is situated at the controller. The controller has four digital outputs, which are checked through a feedback to the controller, and additional six PWM outputs. For safety reasons, all outputs are connected via an AND gate. The [AND gate](#) does only connect through if the voltage supply of the controller is stable and the controller is in faultless operation. If a fault is detected by the software, the micro-controller switches off the AND gate through a control line. Each PWM output contains a control circuit (Figure 4), which enables the current control of the PWM outputs. Via the CANopen object directory it is also possible to deactivate the current control in order to directly adjust the pulse-pause ratio. Also, it is possible to individually adjust the PWM frequency (200 Hz to 1000 Hz).

The controller sends the following PDOs: the evaluated analog inputs with 12-bit resolution, digital input level or frequency, the keys of the HMI keypad and the current position of the joysticks, and a PDO that forwards data from the display. It receives the following PDOs: the current set point for every PWM output, the condition of the digital outputs, the LED actuation of the HMI keypad and the joysticks, and a PDO to forward data to the display.

With the CANopen object directory, the following configurations are possible:

- ◆ Individually configuring digital inputs as NPN or PNP inputs,
- ◆ Individually configuring analog inputs for four operating modes,
- ◆ Saving the complete object directory in EEPROM - this special feature has retrospectively been implemented to avoid an adjustment of the complete object directory when restarting,
- ◆ Flexibly adjusting the PWM frequency,
- ◆ PWM outputs with current control or via the direct adjustment of the pulse-pause ratio,
- ◆ Button-pressed-time to get into special operator interaction,
- ◆ Reading the software version of the Moba components. ▷

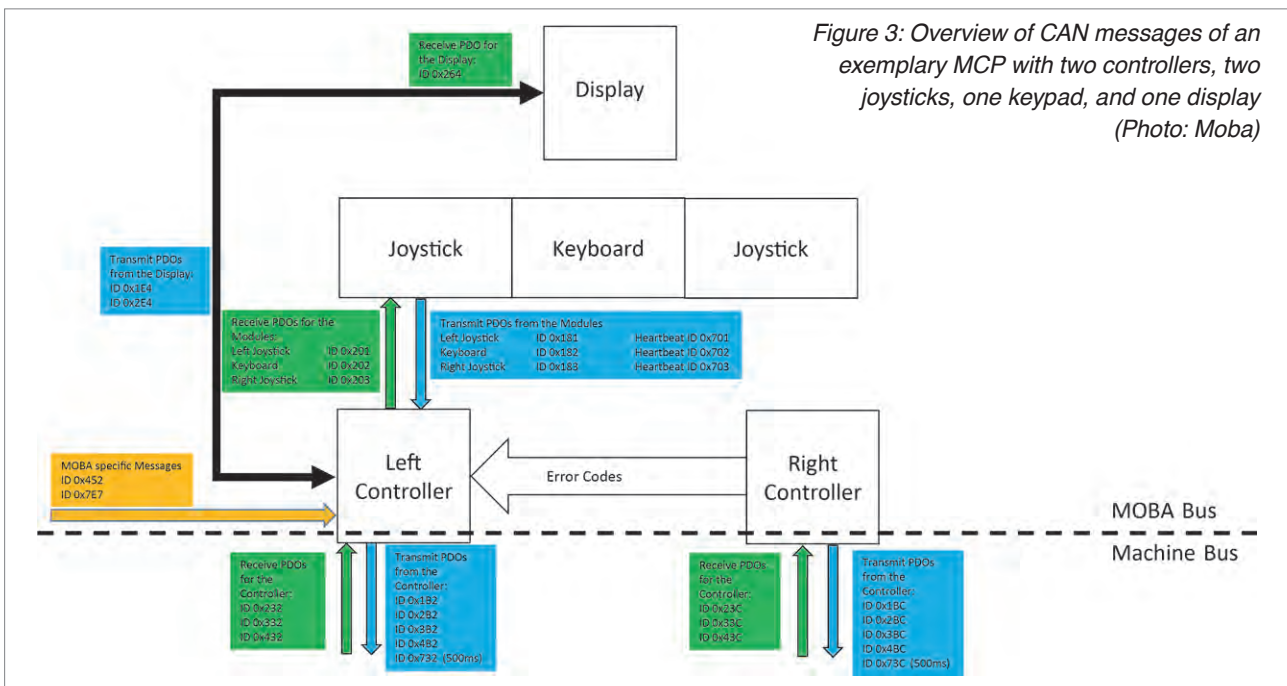

Figure 3: Overview of CAN messages of an exemplary MCP with two controllers, two joysticks, one keypad, and one display (Photo: Moba)



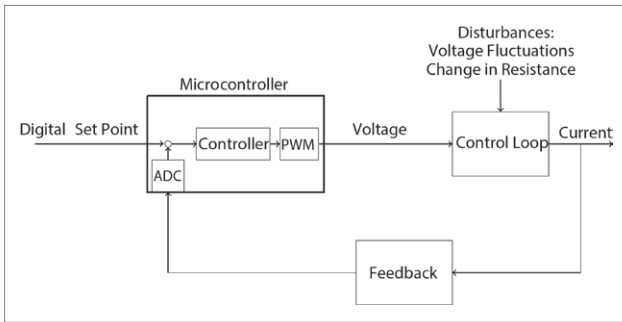

Figure 4: Design of the control structure in the controller  
(Photo: Moba)

## Conclusion

All things considered, the described controller is the right choice for a space-optimized cabinet, which does not allow too much cable work and thus requires special terminal strips. Furthermore, by saving considerable amounts of clamps and cables, the associated wiring work is omitted, thereby reducing wiring faults to a minimum. The possibility of a time-efficient exchange is an extra advantage for the machine manufacturer's service team, saving considerable resources. ◀



### Author

Sebastian Schneider  
Moba Mobile Automation  
[sschneider@moba.de](mailto:sschneider@moba.de)  
[www.moba.de](http://www.moba.de)

# CiA

*CAN in Automation*

We offer CAN and CANopen training for development engineers and system integrators. Topics include application fields, physical layer, protocol, communication services, standardization, and certification.

## *Seminars for newcomers*

- ▶ Classical CAN and CAN FD seminars
- ▶ CANopen seminars
- ▶ CAN FD special seminars
- ▶ CANopen safety seminars
- ▶ CANopen subsea seminars
- ▶ In-house seminars



*For more details please contact  
CiA office at [events@can-cia.org](mailto:events@can-cia.org)*

***[www.can-cia.org](http://www.can-cia.org)***



*CAN in Automation*

The non-profit CiA organization promotes CAN and CAN FD, develops CAN FD recommendations and CANopen specifications, and supports other CAN-based higher-layer protocols.

## *Join the community!*

- ▶ Initiate and influence CiA specifications
- ▶ Receive information on new CAN technology and market trends
- ▶ Have access to all CiA technical documents also in work draft status
- ▶ Participate in joint marketing activities
- ▶ Exchange knowledge and experience with other CiA members
- ▶ Get the CANopen vendor-ID free-of-charge
- ▶ Get credits on CANopen product certifications
- ▶ Get credits on CiA training and education events
- ▶ Benefit from social networking with other CiA members
- ▶ Get credits on advertisements in CiA publications

*For more details please contact CiA office  
at [headquarters@can-cia.org](mailto:headquarters@can-cia.org)*

*[www.can-cia.org](http://www.can-cia.org)*