

March 2016

# CAN Newsletter

Hardware + Software + Tools + Engineering



*Fighting fire with CAN*

*CANopen Safety in mobile machinery*

*Bringing flexibility to E/E architecture*

*Partners in agriculture machines*

*Mobile machines*

[www.can-newsletter.org](http://www.can-newsletter.org)

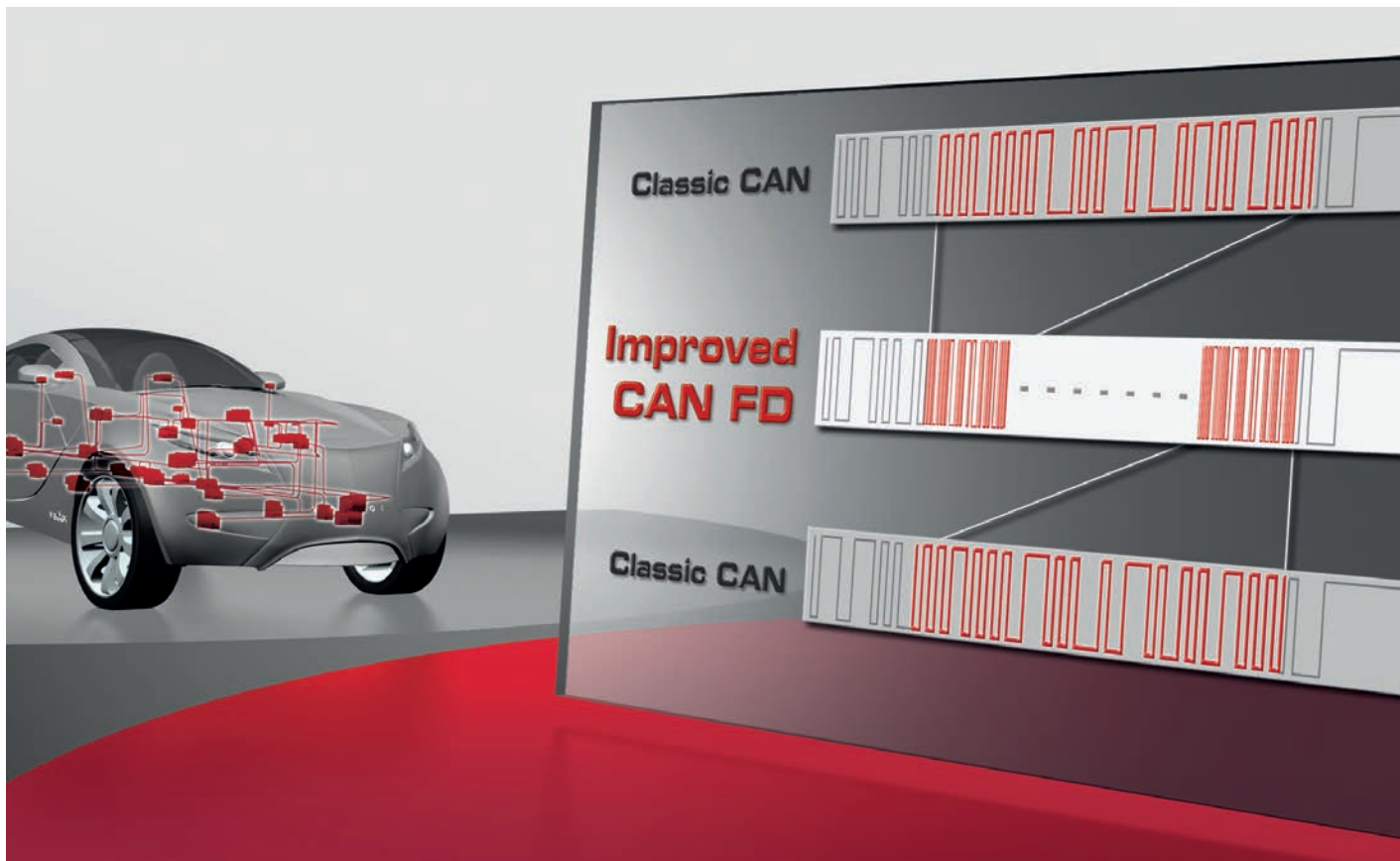

## First class solutions for your CAN and CAN FD based projects

### Complete and universal tool chain

**Increase the efficiency of your projects with the use of the complete tool chain from Vector:**

- > Tools for testing, flashing and calibrating ECUs
- > Flexible bus network interfaces
- > High performance Scope for bit accurate signal analysis
- > Easy to configure AUTOSAR basic software
- > Worldwide engineering services and trainings

Information and downloads: [www.can-solutions.com](http://www.can-solutions.com)

**More CAN power: benefit from over 25 years of networking experience.**

**CAN/CAN FD Poster**  
now order for free:  
[www.vector.com/canfd\\_poster](http://www.vector.com/canfd_poster)



## Mobile machines

Fighting fire with CAN	4
CANopen Safety in mobile machinery	18
Bringing flexibility to E/E architecture	20
Partners in agriculture machines	24

## Imprint

### Publisher

CAN in Automation GmbH  
Kontumazgarten 3  
DE-90429 Nuremberg

[publications@can-cia.org](mailto:publications@can-cia.org)  
[www.can-cia.org](http://www.can-cia.org)

Tel.: +49-911-928819-0  
Fax: +49-911-928819-79

CEO Holger Zeltwanger  
AG Nürnberg 24338

### Downloads last issue:

2472 full magazine  
2618 single articles

### Editors

[pr@can-cia.org](mailto:pr@can-cia.org)

Annegret Emerich  
Cindy Weissmueller  
Holger Zeltwanger  
(responsible according  
to the press law)

### Layout

Nickel Plankermann

### Media consultants

Gisela Scheib  
(responsible according  
to the press law)  
Meng Xie-Buchert

### Distribution manager

Meng Xie-Buchert

### © Copyright

CAN in Automation GmbH



## Devices

From line topology to star repeater	26
20 years of CiA 401	34

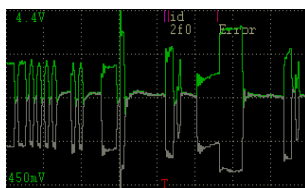

## Engineering

Physical layer really matters in CAN	8
Ringing suppression in CAN FD networks	12
The service robot Care-O-bot 4	36

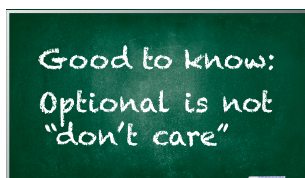

## Knowledge

Good to know: Optional is not "don't care"	42
--	----



## Semiconductors

Customized ICs reduce costs	28
Safety-integrated hardware solutions	40

## Meet us at the Embedded World

The Embedded World exhibition takes place in Nuremberg, Germany from February 23 to 25, 2016. Be it security for electronic systems, distributed intelligence, the Internet of Things or e-mobility and energy efficiency – the trade fair enables you to experience the whole world of embedded systems. Of course we are also part of it. Meet us in hall 1 (stand 630).

# Fighting fire with CAN

*Fire-fighting trucks are needed in truly precarious situations, regardless of whether it's a fire fighting or rescue operation. During an operation, 100 % availability of the electronics systems is vital in the truest sense of the word.*

Figure 1: Three-axle ARFF vehicle with boom (Photo: Rosenbauer)



Every little boy daydreams of fire-fighting trucks, an emotional connection that is not lost as we get older. The worldwide annual demand for fire-fighting trucks is 17 000 units, whereby the industry is divided into a group of global, international players, and a group of very small-scale manufacturers. There is at least one local manufacturer in every country on earth. The procurement of fire-fighting trucks typically occurs through municipalities (states, state governments, communities) or large organizations (UN), and municipalities typically try to buy local.

The service life of vehicles varies widely across the globe; professional fire departments replace vehicles approximately every ten years. A typical volunteer fire department in Germany and Austria every 25 years. From global perspective, vehicles in countries with extreme weather conditions have a significantly shorter service life.

Once an original owner decommissions a vehicle, it is typically refurbished and will be used by the next owner for many years to come. The higher-quality the vehicle, ▷



Figure 2: Fire truck in the USA (Photo: Rosenbauer)

## Related articles

- ◆ [TWK: Encoders make mobile elevating work platforms flexible](#)
- ◆ [Ewald K pfer, Andreas Leu \(Jetter\): Electric servo drives prove themselves in outdoor use](#)
- ◆ [Moba: More than devices for road construction machines](#)
- ◆ [Wachendorff: Kindling with a plan](#)
- ◆ [Linde Hydraulics: Walking excavator uses J1939-linked hydraulics](#)

the more frequently this method is used, especially for turntable and aerial ladders. Fire-fighting trucks are subject to very rigid regional standardizations in many countries. Even the average layman can recognize the big hemispheres of the USA and Europe, which utilize completely different vehicle concepts and operational tactics. The result is that vehicles utilize drastically different operations, lights, weights, electronics, and technology, with the exception of a few large-scale productions.

The equipment even differs drastically among smaller European markets, which is why single unit custom-built vehicles are so widely discussed. In terms of electronics, there are three primary challenges. First, the extremely long service life of the vehicles and thus the permanent necessity to somehow replace discontinued units in order to keep the vehicles operational. Second, differing levels of technology when compared worldwide. On the one hand,

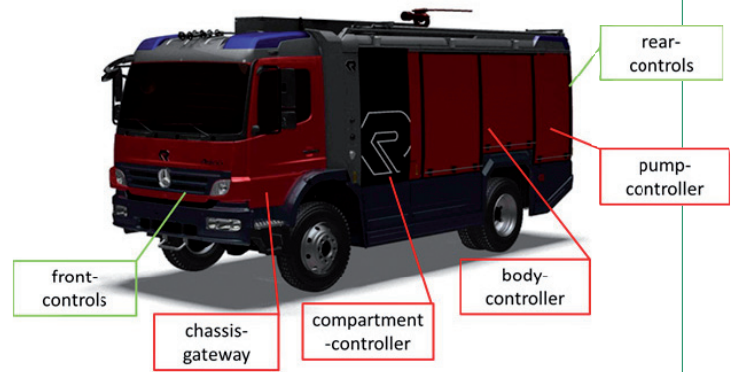
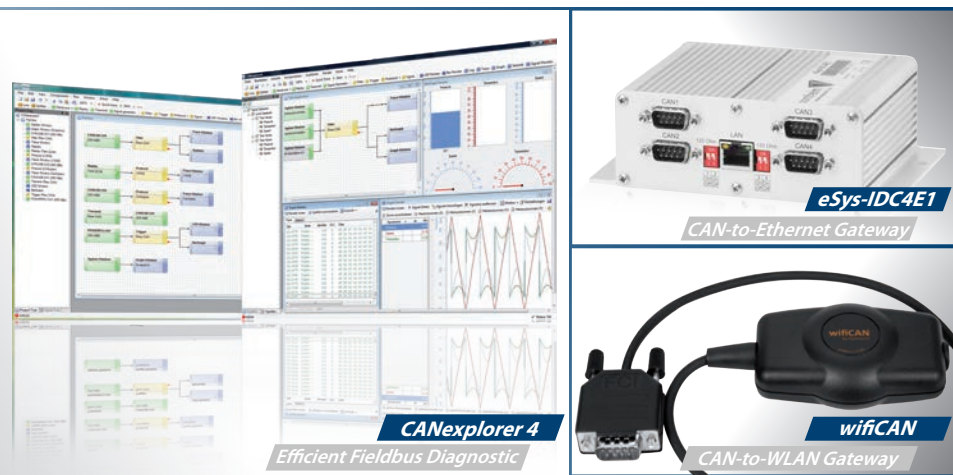

Figure 3: Typical electronics distribution for municipal vehicle (Photo: Rosenbauer)

state-of-the-art, highly technological functions and operations, automated if possible, in divergent markets and thus an absolute focus on simplicity and robustness, far removed from any gimmicks. To achieve this wide range with corresponding common parts in terms of electronics is a very big challenge. Third, once each vehicle is equipped with all of the various functions, equipment and components desired by the customer, the respective variance is primarily reflected in the software. Keeping the software lean while satisfying the needs of customers and being able to debug represents a big challenge. A fire-fighting truck consists in principle of two parts, the chassis (purchased or developed in-house) and the specific fire department body module.

Wir leben Elektronik!  
We live electronics!

sontheim  
Industrie Elektronik GmbH



- ▶ Mobile or stationary CAN Interfaces in various form factors with WLAN, Ethernet, USB and more
- ▶ Robust and flexible CAN Gateways and Data Logger with up to 256GB of built-in NAND-Flash-Memory
- ▶ Rugged ECUs for controlling, telemetry services and diagnostic application
- ▶ Monitoring and analyzing - our modular software tools for efficient fieldbus diagnostics
- ▶ Searching for a modular diagnostic tool based on standards?

<http://www.s-i-e.de/en/products/diagnostics/mdt>

## Start to Get Free - More Flexibility With Our High-Performant CAN Solutions

As your reliable partner for innovative CAN systems we support you with our tools in all phases of your projects, from design over implementation to testing.

**bauma 2016**  
THE HEARTBEAT OF OUR INDUSTRY  
11. - 17. April, M nchen  
Bauma 2016, Munich  
11.04 - 17.04.2016  
Hall A3, Booth 210

Sontheim Overview and Portfolio:

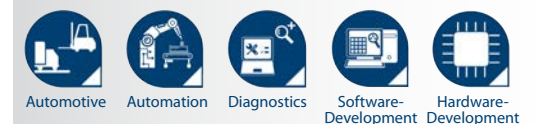

We live electronics!  
[www.sontheim-industrie-elektronik.de](http://www.sontheim-industrie-elektronik.de)

DE Sontheim Industrie Elektronik GmbH  
Georg-Krug-Str. 2, 87437 Kempten  
Tel: +49 831 57 59 00-0 - Fax: -73  
info@s-i-e.de

US Sontheim Industrial Electronics Inc.  
One West Court Square, Suite 750  
Decatur, GA 30030  
Phone: +1 (404) 494-7839 - Fax: -7701



Figure 4: Operation via CAN key panels (Photo: Rosenbauer)

### Chassis scope

There are two different types of chassis. In the first type, the fire department manufacturer develops and produces its own chassis. This version is more widespread in the USA, even for municipal vehicles; absolute specialty vehicles prevail in Europe (e.g.: ARFF vehicles). The problem lies therein that very few providers even offer such a specific custom chassis (52 t, 130 km/h). The only alternative to being dependent on these providers is the construction of the chassis in-house. The entire drivetrain with the standard SAE J1939 connections is in the hands of the manufacturer. So technologically very challenging in terms of the concept and integration, sometimes with multiple gateways.

The chassis body differs here, above all due to the drive concept, since there are vehicles with a different number of axles on which various gearboxes and up to three diesel motors are installed. The electronics needed for the gearbox, engine, ABS, etc. are connected by way of J1939, whereby complex CAN structures with multiple gateways are created through serial electronic systems with identical node numbers. Even the control of the individual components using CAN is different from supplier to supplier; nearly identical for frequently used functions; sometimes vastly different for lower priority functions. The differences stem from the “freely definable” CAN messages section, primarily, however, the manufacturer-specific interpretation.

For the second type of chassis, the fire department manufacturer buys a standard truck chassis. In this case, the superstructure is connected using the chassis interface from the respective chassis manufacturer. This ensures that the vehicle gateway will not have an unintended effect on the drivetrain. This interface mostly offers its own hardware in- and outputs, where the most important functions can be activated/accessed.

Nearly every chassis manufacturer now offers a CAN interface that enables the functional scope of the hardware signals, supplemented with an entire series of additional signals and functions. The inconsistencies of the different chassis manufacturers is problematic in both solutions.

Neither the hardware interface, nor the CAN interface is the same amongst the different brands. Sometimes the CAN interfaces differ significantly even when they are the same brand and model.

### Body module

A typical fire department municipal vehicle consists of multiple segments such as driving compartment, crew cab, basic superstructure with tanks and equipment compartments, pump, and additional components. Many different fire department manufacturers place the control architecture in accordance with this spatial division.

Driving compartment: at least one electronics assembly sits here, which on the one hand controls the interface to the chassis, and in addition at least for the warning device as well. An operator’s panel is always located in the driving compartment, which has anywhere from just a few standard switches up to highly complex displays depending on the design. Two different crew cab types are available, from the scope of delivery of the chassis manufacturer or as a crew cab specific to the superstructure manufacturer. Only in the 2<sup>nd</sup> case must the different illumination, LED bars, door contacts, central locking, etc. be read of an additional electronics assembly.

A typical municipal vehicle has a large number of side roller shutters and locker hatches, whose status (open/closed) is read into the superstructure module and displayed on control lamps or displays in the driving compartment. The fill levels of the different water and foam compound tanks must be recorded and forwarded via CAN. The control of the vehicle’s surrounding field illumination and the general illumination of the equipment compartments is essential. Due to the LED technology, the total power consumption of the illumination has naturally been reduced; the current peaks are not to be ignored though and must be taken into account accordingly when diagnosing the electronics outputs.

The pump is the actual centerpiece of the fire-fighting truck. The pump itself is largely driven via the power takeoff, since the power requirement is quite significant. Of course there are also solutions using a separated pump motor. The individual pressure and temperature sensors are read-in from the pump electronics and the pneumatic valves are controlled, which are between 3 and approx. 25 pieces depending on the vehicle’s equipment. The abundance of installed functions is determined above all by additional components and thus electronics optionally



Figure 5: “Escape Stair” as a typical safety application (Photo: Rosenbauer)

## CAN Newsletter Online

The CAN Newsletter Online sister publication provides brief product-related information. For more details please visit [www.can-newsletter.org](http://www.can-newsletter.org).



### SPS IPC Drives 2015 *Teleservice generation for mobile machines*

At the SPS, STW presents the software Vehicle Data System (VDS) for access to data, their storage, and analysis in hall 7, booth 150.

[Read on](#)



### Mobiltron 2015 *The bigger picture*

Sensor-Technik Wiedemann (STW) organized the Mobiltron 2015 event presenting solutions on mobile machines. Mavericks got also some slots.

[Read on](#)



### Control system *Suitable for mobile machines*

The increasing complexity of mobile machinery results in growing demands of I/O controllers.

[Read on](#)



### Harvesters *CAN-linked control panel*

Massey is launching two combine harvesters for the 2016 season: the MF 7340 Activa combine, and the six-cylinder powered MF 7344 Activa.

[Read on](#)

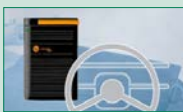

### 3-piece control systems *Dedicated for mobile machines*

Ifm (Germany) has introduced a CANopen-based system comprising control, relay, and display units. The system is intended to replace conventional relay logic.

[Read on](#)



### Rotary telehandlers *CAN management technology*

Bobcat has launched the EVO generation of Stage IIIB/Tier 4 interim rotary telescopic handlers. CAN management technology promises control and safety.

[Read on](#)

connected to CAN. These commonly include pressurized foam proportioning systems, road hazard traffic control devices, various light masts, an array of built-in generator systems and more.

DIN 14700 (section 1-11) nicknamed FireCAN, was created so that many of these units, regardless of brand, can communicate with the bus systems of any fire department manufacturer. These units are separated via gateway with a standardized interface from the bus specific to the fire department and function with Plug-and-Play. Using this interface, for example, portable power generators from multiple manufacturers can be operated on the vehicle's own display, even providing enhanced diagnostics.

## Operating elements

Operating elements are a very important issue, which is always being discussed among fire fighters. Some swear on highly technological display applications, while other users want only conventional switches that are easy to exchange. This divide causes problems for superstructure manufacturers, lower quantities per implementation and thus higher costs.

An increasingly noticeable trend is the use of key panels connected via CAN, key banks and small, compact display units. Therefore, simple vehicles as well as those with a complex functional scope can be easily mapped by increasing the number of control panels. The negative branching into sub-screens is thus forgone and the key label can be adapted to the desires of the customer without software adaptation.

Safety standards specifically for the functional scope of emergency vehicles do not currently exist. Therefore, they are subject to EN 13849, analogs e.g. to machine tools. In disaster control, however, availability extends far

beyond safety. In an emergency situation, the fire department must be able to absolutely rely on its equipment. Switching off or reducing of peripherals and services is counterproductive. The diesel engine of the pump unit must, e.g. continue to run even if the oil is low, as long as the extinguishing crew has been evacuated from the seat of the fire. What counts is lives saved and not avoiding damage to equipment. ◀

### Author

Oliver Hrazdera  
Rosenbauer International AG  
[oliver.hrazdera@rosenbauer.com](mailto:oliver.hrazdera@rosenbauer.com)  
[www.rosenbauer.com](http://www.rosenbauer.com)



# Physical layer really matters in CAN

*One should remember with the CAN physical layer that there exists only impedance, not plain conductors. Let us start with a brief review of the main important transmission line characteristics.*

Despite of the comprehensive knowledge of the CAN physical layer, there is poor tradition in design of physical layer structures for industrial and machinery CAN networks. Cables with “wrong” impedance (not matching with termination) are commonly used and many engineers intentionally select them, because of constrained understanding of the transmission line behavior. Most engineers forget, that the transmission line cannot be considered as conductor with DC characteristics only. “Wrong” impedance leads not only to unmanaged reflections but also to different wave propagation speed in the cable. Unmanaged reflections increase the bit-error probability of the network and the propagation speed difference makes bit timing analysis results invalid.

Turning back to the discrete instrumentation is not an option in modern systems, due to the high accuracy, dependability, and safety requirements [1]. Dependability depends on many things, starting from the physical layer and ending to the application layer communication services and application processing. The case example of this article shows, how well CAN error detection works, even in the case where the physical layer design rules are heavily violated. The presented scenarios exist also in CAN FD, which has similar arbitration and acknowledge fields, but bit-rate transition phases may also be disturbed if transmission line deviations exist.

This article begins with a brief review of the main important transmission line characteristics. For more details readers are advised to read the referred documents. Next, a case example with violated topology, a transmission line mismatch, and too closely installed nodes are presented. After describing the starting point, corrective actions with corresponding results are shown. Finally, some discussion is included and concluding remarks set.

## Many variables

There are many variables in the background of physical layer design constraints. Maximum network length is a direct consequence of the wave propagation speed in the network, selected bit-rate, and bit-timing details specified by the used application layer protocol. The signal shall propagate from one end to another and back within the propagation segment or problems will occur. Equation 1 shows clearly that any change in the transmission line characteristics leads to change of wave propagation time,  $\lambda$ .

$$\lambda = \sqrt{(j\omega L + R) \cdot (j\omega C + G)} \quad [1]$$

Line impedance  $Z_0$  is specified by the corresponding physical layer standard, also applying to the entire medium attachment circuitry of each device and terminators [2]. Any deviation will introduce an unideal operation of the entire network. The actual line impedance depends on the transmission line characteristics according to equation 2. It clearly shows that series resistors in signal lines, which are commonly used in passive star topology implementations, increase significantly the line impedance. Equation 3 shows that the increased line impedance results over- and undershoots, and inverse reflections are caused by transition to the standard line impedance.

$$Z_0 = \sqrt{\frac{j\omega L + R}{j\omega C + G}} \quad [2]$$

Termination has a significant effect on the overall dependability. It is much more than just a DC resistance – its main purpose is to prevent reflections from the network endpoints. Equation 3 shows formula for the reflection factor,  $\rho$ . If termination impedance  $Z_T$  equals line impedance, the reflection factor is zero and reflections do not exist. Accordingly, if the termination impedance is smaller than the line impedance, inverse polarity reflections exist and if the termination impedance is higher than the line impedance, the reflection polarity is same with the originating edge. The higher the mismatch is, the higher the reflection amplitude becomes.

$$\rho = \frac{Z_T - Z_0}{Z_T + Z_0} \quad [3]$$

The number of nodes mainly depends on the ratio of fan-out, fan-in of the transceivers, and load caused by the transmission line. The nominal number of nodes typically applies, when transmission line characteristics meet the corresponding standard [2]. If e.g. the line capacitance is higher than specified, the maximum achievable line length is reduced. Protection circuits shall be used carefully, especially so called EMI-capacitors and common-mode chokes [3] [4]. According to Figure 1, high-resistance termination of long drop-lines collapse the maximum number of nodes in a network and is thus not recommended for the implementation in industrial systems.

The maximum length of a single drop-line,  $L_i$ , is interesting, because it is hard to find a well explained description for the values presented in the corresponding standard [2]. Each drop-line is an unterminated end, causing reflection having same polarity than the originating edge, overshoot for rising and undershoot for falling edge. Reflection ▶



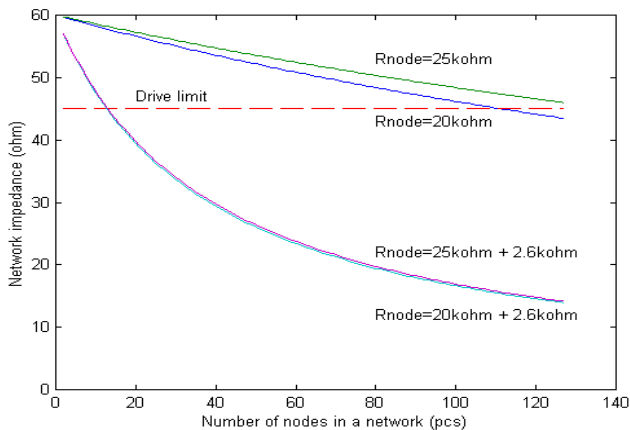

Figure 1: Maximum number of nodes in a network under various conditions

shall occur in the first 33 % of the propagation segment.  $T_{TRANS}$  is the typical transition time of transceivers. Down-and-back propagation shall be considered by using the double propagation time. The traditional extension mechanism with slew-rate control does not apply for higher bit rates and CAN FD, because there is no extra time margin for longer transitions. E.g. for the standard CANopen network with  $\lambda = 5$  ns/m and transceivers with average 50 ns rise and fall times, equation 4 results the maximum drop-line length of 1,67 m [5], which is perfectly in line with practical experience on high-speed CAN networks.

$$L_i = \frac{1}{3} \cdot \frac{T_{TRANS}}{2 \cdot \lambda} \quad [4]$$

The most interesting variable is the minimum length between each two devices in the network,  $d$ . Background for such a variable is very simple – a group of nodes connected close to each other introduce the lumped load capacitance  $C_L$ , increasing the nominal line capacitance  $C_0$  of the short range of the cable, into which they are connected. The result is two impedance junctions, from higher to lower and from lower to higher [6]. Equation 5 applies for computing the minimum distance between the nodes.

$$d > \frac{C_L}{0.98 C_0} \quad [5]$$

## Case example

A case example is based on the real troubleshooting case, where a dual start topology network with passive star-couplers was the original set-up. There was a relatively long continuous network segment without any devices between the two stars. Communication problems seemed to occur randomly, but often. Analysis of log files revealed, that problems occurred when two devices from opposite ends of the network arbitrated.

The screenshot in Figure 2 shows an example of CAN error detection capabilities and how a locally detected error is globalized. Data frame starts normally with dominant start-of-frame (SOF) and ID10 bits, followed by recessive ID9 bit. Then, ID8 seems to be dominant and ID7 to ID4 recessive. But the first active error flag followed by another one reveals the entire problem. The most important occurrence is that the second active error flag has as high



## CAN Bus Plug & Play M12 Bus Connectors

- Reliable data transmission due to
  - failure-free M12 connection
  - fully shielded robust metal housing
  - safe effective shield termination
- Quick connection – Plug & Play M12

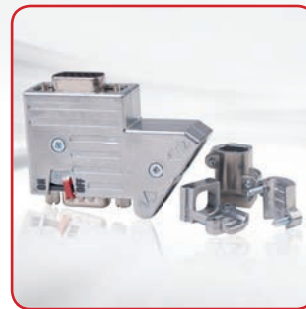

## CAN Bus Connectors External Cable Clamp

- Secure field assembly for thick special cables e.g. drag chain cables
- Solid metal external cable clamp for safe strain relief and shield termination
- EMI/RFI proof fully shielded metal housing

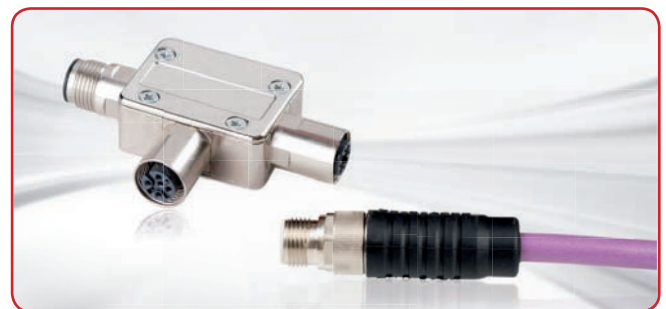

## CAN M12 Cable connectors + Cordsets and T + Y pieces (splitters)

- Secure data transmission due to crimp technology for wires and for shield
- EMI/RFI proof fully shielded metal housing for rough environment
- Torsion- and vibration-proof strain relief and shield connection
  - Approved by certified shock/vibration test acc. to DIN EN 61373 Category 1, class B
- Compact dimensions with small outer diameter
- For railway applications with materials acc. to DIN EN 45 545 and NFF 16-101 available



## CAN Bus distribution boxes and service boxes

- EMI/RFI proof full metal housing
- Machined D-Sub contacts for high reliability
- Customized design
- PCB with customized special insulation as option





Figure 2: Erroneous arbitration

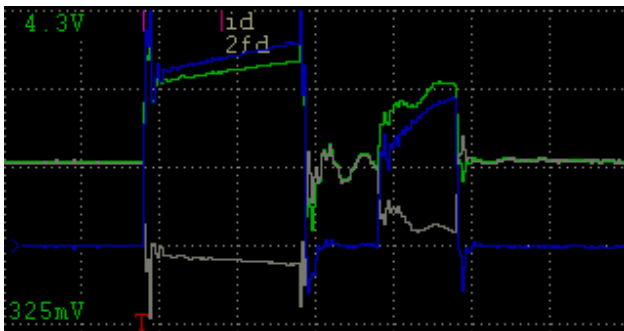

Figure 3: Problematic scenario in ID8 bit with linear network

amplitude as acknowledge (ACK) bit. It means that the first active error flag, with lower amplitude, is transmitted by a single node. Error flags also confirm that ID8 is erroneously interpreted into recessive by one node. Every local error is efficiently globalized by an active error flag, violating bit-stuffing rule and causing more global error detection and reaction.

ID8 in the transmission re-try starting after the erroneous transmission seems to be almost as bad as in the erroneous transmission, but it was still received successfully. Detailed analysis showed that there were only four CAN-IDs existing after error frames, being the potentially failing ones. Key thing was that the similar bit-pattern from ID10 to ID4 existed in all those CAN-IDs. System documentation revealed that messages with such CAN-IDs were transmitted by at least one device close to each end of the network. Analysis confirmed that the passive star-couplers with series resistors in CAN-high and CAN-low and long unterminated drop-lines were introducing the line mismatch.

## System improvements

Because of the heavy topology violation, the first corrective action was re-organizing the cabling from dual star into linear bus topology. Also the star-couplers causing the transmission line mismatch were removed. The result is clearly visible in Figure 3, where the beginning of the bit ID8 is significantly more stable and dominant state amplitude in the sample point at 75 % to 87,5 % is approximately 1,8 V or higher. Error frames were not seen anymore. However, the beginning of the bit-time had to be improved, because the dominant state amplitude went below the 1,2 V threshold [2] during the first quarter of the bit-time.

After correcting the line impedance and network topology from dual star to linear, the structure still contains



Figure 4: ID8 bit waveform with longer daisy-chaining cables

a long continuous cable with many devices in both ends installed close to each other. Such structure conforms the one presented in the literature [6], which gave clear advice for further improvement.

Second corrective action was the replacement of 0,5 m long daisy-chaining cables in the node group in one end of the network with 1,5 m long cables. Nodes in the other end were installed in the locations, where such improvement was too time-consuming and thus that end was left intact in the system under repair. Figure 4 shows that the improvement was significant. Dominant state amplitude exceeded 1,5 V during the entire bit-time and 1,8 V in the sample point.

## Discussion

The example scenario in the literature [6] concentrates on the scenario, where a single node controls a set of devices in an island, over a long cable connection. The scenario is typical for the old system architectures, where capability of a single PLC is extended with I/O devices, concentrating sensor, and actuator connections. Concentrating into a fixed scenario hides an important detail. Connected nodes increase the capacitance of the network cable. When the nodes are connected into a short range of network cable and a long range of the cable exists without any nodes, the capacitance change is concentrated in the short range of the cable.

Modern approach is to use intelligent sensors and actuators directly connected to the network. When a higher number of devices is connected to a network, they are installed more evenly along the network cable. Such approach changes the cable capacitance more evenly and results in much smaller impedance transitions in the cable. There are e.g. optical hub implementations, where minimum distance between the nodes is approximately >

### Related articles

- ◆ [Bernd Elend \(NXP\): CAN FD: Impact on system design](#)
- ◆ [Magnus Hell \(Infineon\): The physical layer in the CAN FD world](#)
- ◆ [Steve Corrigan \(†\): Common-mode effects in CAN networks](#)
- ◆ [Steve Corrigan \(†\): Minimum distance between CAN nodes](#)
- ◆ [Steve Corrigan \(†\): CAN physical layer protection hints](#)

20 mm [7] [8]. Problems do not exist, because the entire network length is approximately 200 mm long, the nodes are evenly distributed along the network and properly terminated at both ends. It can be concluded based on referred information, that instead of a fixed minimum distance between two nodes, the nodes should be distributed as evenly as possible along the network cable. Furthermore, if the system structure leads to groups of nodes, minimum length a daisy-chaining cable may need to be extended accordingly [6].

Increased distribution provides advantages also in functional safety integrity level. Decreased residual error probability according to the increased number of nodes in a network has been well known for long time [9]. There are also application layer safeguards, which are effective: This increases with the number of nodes in the network [10]. However, the most significant increase in functional safety may be achieved by replacing all discrete I/O-signals with direct network communication [1]. The increase is mainly outcome of the significantly higher diagnostics coverage provided by digital packet communication.

While network communication is significantly more dependable and safe than discrete instrumentation, special attention to safety integrity level shall still be paid. The latest published residual error probability analysis confirmed that bit-error probability is one of the most fundamental parameters [11]. Electromagnetic interference is an external threat and there are well-known protection mechanisms, but topology violations and transmission line mismatches have direct and permanent effect on the entire communication. If the transmission line has such problems, bit-error probability of communication over such network is increased, which may decrease the safety integrity level below the required level. It is too often forgotten that the use of proper cabling approach and components helps in realizing installations, which fulfill the requirements taken into account during the design.

## Conclusions

This article describes briefly a review of the most essential transmission line characteristics. In addition, a case example was introduced in order to prove that the presented theories really apply to the real world transmission lines. The main outcome of the case example was that all the main knowledge is available for everybody, one just needs to learn and utilize the knowledge. Each system has something special, requiring deep understanding of the transmission line characteristics in order to avoid pitfalls. Especially, when star or mixed topologies are needed, it is a waste of time and money to implement such without active topology components.

Ever increasing accuracy, dependability, and safety integrity level requirements have lead to a demand for changing from discrete into digital network based instrumentation. Violating transmission line specifications is wasting the dependability and safety margin. In addition to the increased dependability, network-based instrumentation provides a more flexible system architecture. However, doing the design work properly is not enough, it shall also be ensured that the proper designs

## CAN Newsletter Online

The CAN Newsletter Online sister publication provides brief product-related information. For more details please visit [www.can-newsletter.org](http://www.can-newsletter.org).



SAE J1939-15

### *Physical layer updated*

Recently, SAE has released a revised version of the J1939-15 CAN physical

layer for Unshielded Twisted Pair (UTP) cable. The bit-rate is determined to be at 250 kbit/s.

[Read on](#)



### *Physical layer tester for CAN and LIN*

The Mx-PLT by Danlaw (USA) is a physical layer tester for Mx-Suite, which is an embedded software test environment. The PLT is a desktop solution that automatically performs CAN network physical layer tests.

[Read on](#)

can be implemented in the assembly lines and maintained in the field service. When the world starts turning from CAN to CAN FD, the physical layer implementations shall more closely follow the good design practices.

[Kurt Zadek Lewin's](#) (1890-1947), German-American psychologist and father of the modern social psychology, words apply perfectly to the transmission lines: „There's nothing so practical as good theory.” ◀



#### Author

Dr. Heikki Saha  
TK Engineering  
[www.tke.fi](http://www.tke.fi)  
[References](#)

# Ringingsuppression in CAN FD networks

*In star and hybrid topology networks, the ringing needs to be suppressed in particular at higher bit-rates. This can be achieved by the method described in the CiA 601-4 specification.*

When using line topology with a proper termination and connecting just two nodes, there is no significant ringing on the bus. Connecting more than two nodes, the ringing becomes an issue. With unterminated stub-lines the ringing becomes serious. In star topologies and hybrid topologies, the ringing can corrupt the communication. This means, it is necessary to suppress the ringing. From the compatibility point of view, suppressing signal ringing is promising to achieve higher data rates in CAN communication without drastically changing the existing controlling hardware and software.

The increase in the number of connected ECUs enlarges the signal ringing, as well as the probability of communication errors. Therefore network size is limited to establish communications, also in Classical CAN networks. This is even more critical in CAN FD networks running at higher bit-rates (e.g. 2 Mbit/s). Of course, you can reduce the number of nodes in a network segment and introduce a second segment interconnected by means of a gateway ECU. However, using gateway ECUs leads to cost increase and communication delays. Therefore, a technology is needed to suppress the signal ringing, which enables expanding the network size. For suppressing the signal ringing, introducing filter circuits and ferrite are usually taken. However, this dampens not only the ringing but also the signal itself depending on the position and the number installed. As a result, the signal rounding might increase communication delays.

## The CAN FD physical layer

CAN FD networks use transceivers compliant with ISO 11898-2 qualified for the chosen data-phase bit-rate

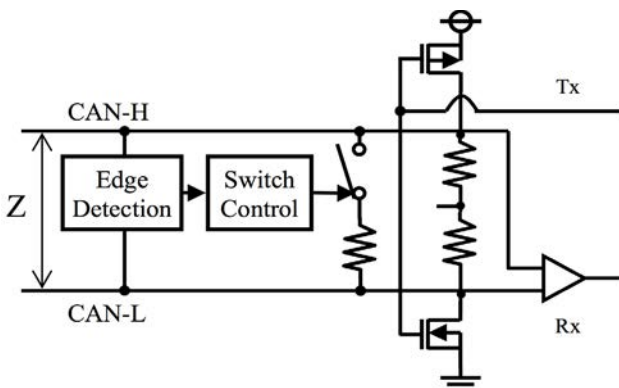

Figure 1: Principle of the ringing suppression circuitry (RSC) (Photo: Denso)

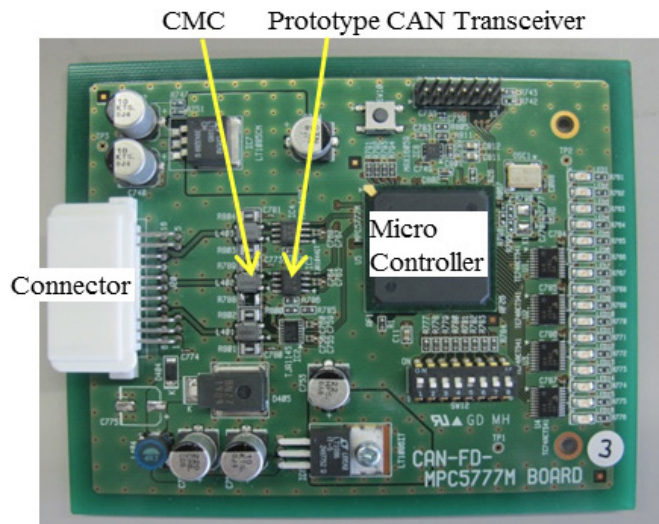

Figure 2: Evaluation board using CAN transceivers compliant with ISO 11898-2:2016 integrating the ringing suppression circuitry (RSC) as specified in CiA 601-4 (Photo: Denso)

(e.g. 2 Mbit/s or 5 Mbit/s). The topology is not internationally standardized. Depending on the used topology, the system designer specifies the sample-point of the bit-timings for the data-phase and the arbitration phase. Due to the in-bit-time detection in the arbitration phase, the maximum speed is limited to 1 Mbit/s. In the data phase, when only one node transmits data, it is possible to send at higher speeds. The dominant and recessive periods are determined by the value of the differential voltage at the sample-point set in the second half of the bit. The position of the sample-point in the data-phase is independent of the sample-point in the arbitration phase.

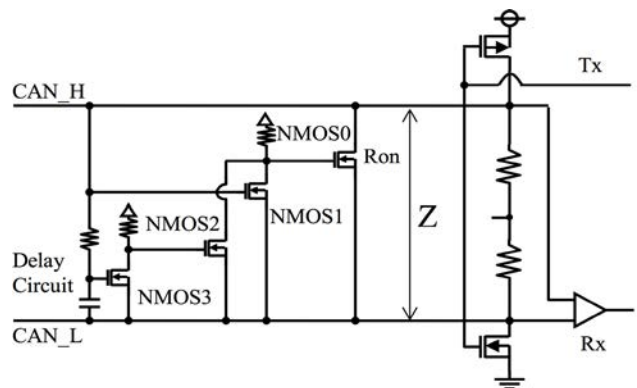

Figure 3: RSC implementation used in Denso's study (Photo: Denso)

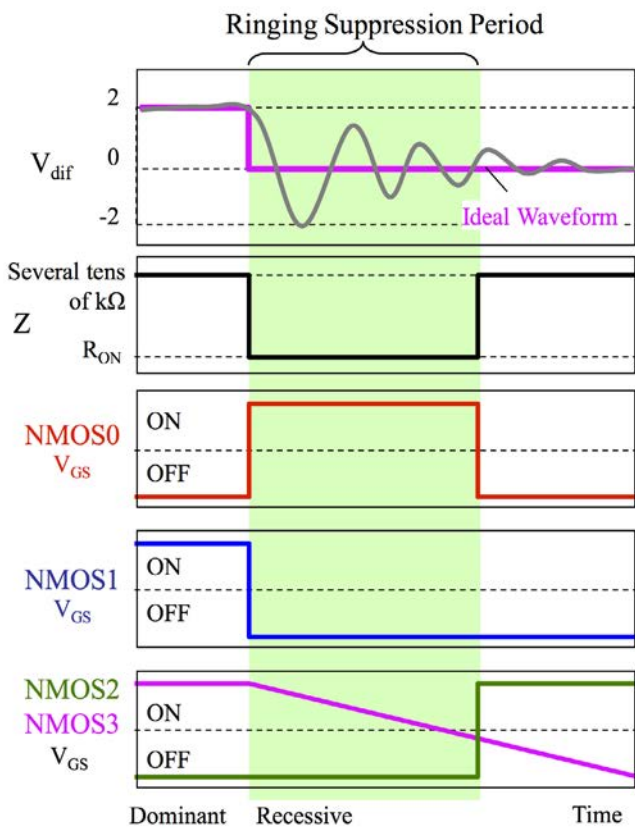

Figure 4: Operating principle on proposed circuitry (Photo: Denso)

In CAN FD networks with more than two nodes, a ringing is generated by the reflections of communication voltage wave, which occur because of impedance mismatches in a network at the signal transition frequencies. The impedance mismatches occur mainly at not-terminated nodes and the junction. When a transmitter outputs recessive state, the output of the transmitter has a high resistance. Therefore large signal ringing occurs in the transition from recessive-to-dominant, in particular. In addition, a negative reflection occurs at a junction because the impedance decreases at a junction, which means lower than the characteristic impedance. When ringing does not converge below predetermined voltage by the sampling point, a bit malfunction occurs. Therefore the network size is limited to establish communications.

Because ringing does not depend on the transmission rate, the ringing in the “high-speed” data-phase is the same as in a “low-speed” arbitration phase. However, bit-width shortens when the transmission rate becomes higher. Therefore the time from bit transition to the sampling-point is shortened. The ringing is to be converged earlier in the data-phase than in an arbitration phase.

In CAN FD, when a bit-inversion occurs in the reception waveform, an error is detected by various error detection functions in the receiver. After that, the communication is maintained by requesting a re-transmission to the transmitting node. However, constant ringing may occur depending on the network configuration, which overrides this re-transmission method. So, the criteria is set for establishing communication as the longest ringing convergence time by the received voltage level gives valid state of dominant/recessive at the receiver.

The level of the differential voltage at the sample-point determines if the bit is regarded as dominant or recessive. ▷

# Industrial Ethernet Gateways / Bridges

CAN / CANopen  
EtherCAT  
PROFINET



## CAN-EtherCAT

- Gateway between CAN/CANopen and EtherCAT
- Additional Ethernet interface for EoE

## CANopen-PN

- Gateway between PROFINET-IO and CANopen
- PROFINET-IRT capable
- Simple configuration via S7 manager or TIA portal

## ECX-EC

- EtherCAT slave bridge
- Process data exchange between two independent EtherCAT networks
- DC synchronization between EtherCAT masters

**embeddedworld2016**  
Exhibition & Conference  
... it's a smarter world  
Hall 5, booth 169  
in Nuremberg 23.-25.02.2016

**HANNOVER MESSE**  
Hall 9, booth F17  
25.-29.04.2016



esd gmbh  
Vahrenwalder Str. 207  
30165 Hannover  
Germany  
Tel.: +49-511-3 72 98-0  
info@esd.eu  
www.esd.eu

US office:  
esd electronics, Inc.  
70 Federal Street - Suite #2  
Greenfield, MA 01301  
Phone: 413-772-3170  
us-sales@esd-electronics.com  
www.esd-electronics.us

www.esd.eu

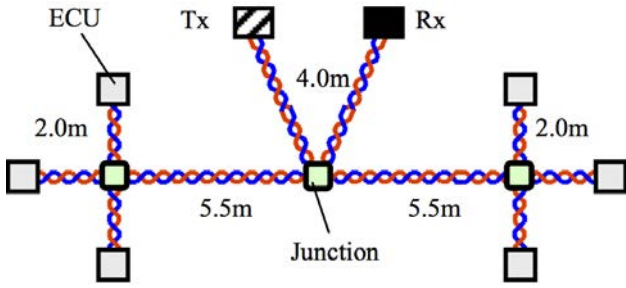

Figure 5: CAN FD network configuration with eight nodes used in Denso's study (Photo: Denso)

Because the threshold defined for the recessive state is less than 0,5 V, the ringing voltage at the transition from dominant-to-recessive must converge to less than 0,5 V at the sample-point..

### Experimental study and its results

In our study, the transmission rate of the arbitration phase was set to 500 kbit/s and the transmission rate of the data phase to 2 Mbit/s. At first, the process in the arbitration phase is the same as in Classical CAN, so it is necessary to consider a propagation delay from a transmission node to a reception node. Considering the above, the ringing convergence time at state transition from dominant-to-recessive was set less than 841 ns as the criterion for establishing communication.

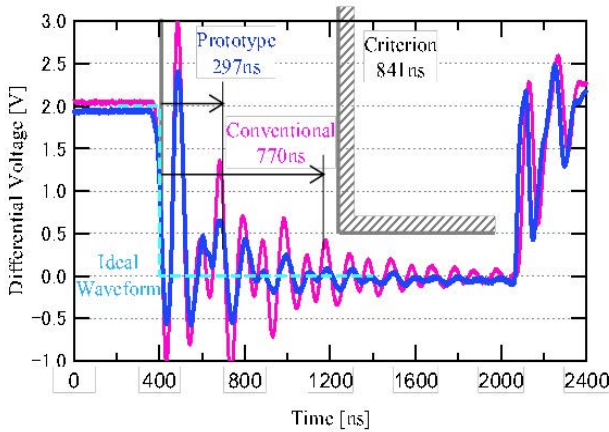

Figure 6: Waveform on 8-nodes configuration at BRS bit (Photo: Denso)

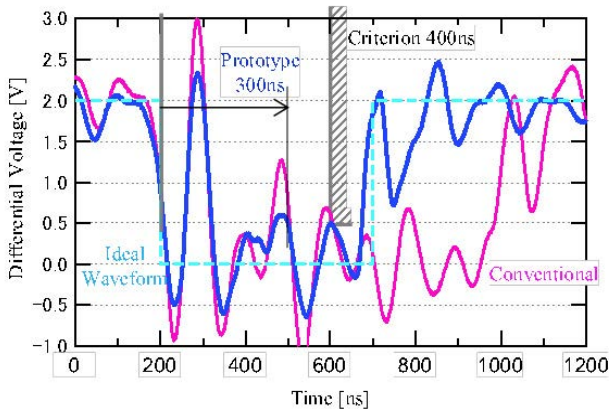

Figure 7: Waveform on 8-nodes configuration at DLC3 bit (Photo: Denso)

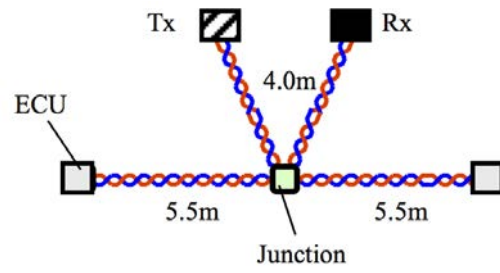

Figure 8: Possible largest network using conventional CAN transceiver without RSC (Photo: Denso)

Secondly, in the data phase, the time from the bit transition to the sampling point is set as criterion for establishing communication because the propagation delay of the bit, which other nodes transmitted, is unnecessary to be considered. In our study, a sample-point was set as 80 % of the nominal bit-time. Because the bit width is 500 ns, in the case of 2 Mbit/s, the ringing convergence time at state transition from dominant-to-recessive was set less than 400 ns as the criterion for establishing communication of the data phase.

We used in our study a method of ringing suppression by reducing the impedances of unterminated nodes. As for the signal frequency band, CAN network has a 60-Ω impedance for transmitters because usually two split terminations as total 120 Ω are installed and unterminated nodes have a higher impedance. The CAN transceiver is designed so that the dominant voltage is 2 V with 60-Ω load connected. Therefore, the impedance of unterminated nodes must be higher during the dominant period to avoid a voltage drop. In addition, higher impedance is also necessary because other nodes might start dominant output in the second half of a bit in recessive period and lowering the impedance interrupts. However, the drop in impedance does not influence CAN communication during the first half of the recessive period, which enables the operation to the impedance of non-terminated nodes to suppress the ringing using this period. We developed a ringing suppression circuitry (RSC) compliant to CiA 601-4 that detects the transition from dominant-to-recessive states based on the received voltage and reduces its impedance for a certain period while suppressing the ringing.

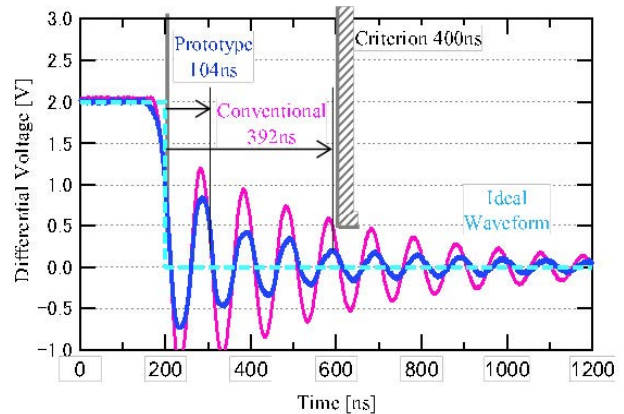

Figure 9: Waveform on 4-nodes configuration at DLC3 bit (Photo: Denso)

The proposed RSC is composed of four MOS components and a delay circuit. NMOS0 has the role to suppress the ringing and it is equivalent to the series circuit comprising a resistor and a switch. The ON resistance of NMOS0 has a value that is almost equivalent to the characteristic impedance of the twisted pair cable. So, NMOS0 absorbs the incoming voltage wave of ringing frequency, which suppresses the ringing. NMOS0 is applied with a gate voltage when both NMOS1 and NMOS2 connected between its gate and source in parallel turn OFF. The gate voltage is in the range between the voltages of the voltage source and CAN\_L.

NMOS1 has a role to detect the falling edge of the bus voltage at the time of transition from dominant to recessive states, and start the ringing suppression function. The gate voltage of NMOS1 is the differential voltage between CAN\_H and CAN\_L. Therefore, it is applied with approximately 2 V at the dominant state, which turns NMOS1 ON. On the other hand, the gate voltage of NMOS1 becomes approximately 0 V at the recessive state, which turns NMOS1 OFF. In this way, NMOS1 becomes OFF only at the recessive state.

NMOS2 and NMOS3 in a pair have a role to end the ringing suppression function after a certain period since the state transition from dominant to recessive states. NMOS2 is required to invert the ON-OFF state of NMOS3. The gate voltage of NMOS3 is applied with the bus voltage passing through a delay circuit. Therefore NMOS3 is in ON state during the dominant

state. The state is maintained right after transition from dominant to recessive states during a certain period defined by the delay circuit. Because both NMOS1 and NMOS2 are in OFF state during this period, NMOS0 is ON and suppresses the ringing. After that when NMOS3 turns OFF, NMOS0 turns OFF and the ringing suppression is ended. In this way, a simple circuit composed of only four MOS components can suppress the ringing.

In our study, the criterion for the bus differential voltage was set as less than 841 ns for its convergence time. Therefore, the worst case is when the amplitude of the reflected wave is the largest and its period is the longest. The maximum amplitude occurs when the reflectance at junctions is the highest and a reflection wave arrives at the receiving nodes comprising multiple reflection waves arriving all at once. Furthermore, the maximum period occurs when the length of the transmission path is the longest. In the network used for our study, all nodes except those for transmission and reception are connected to the junctions of both ends to assure maximum reflectance at the junctions and the junctions are located at isometric and farthest positions from the receiving node to receive reflection waves latest at the same time. If the communication is not established in the 8-nodes network configuration, the nodes connected at the junction of both ends are reduced until the communication is established.

A prototype CAN transceiver was developed embedding RSC as specified in CiA 601-4. Additionally, we designed an evaluation board equipped with a CAN FD ▶

# LIN & CAN Bus simulation for test and production

The advertisement features a central computer monitor displaying simulation software with a macro table. A hand is shown holding a device connected to the system. Various hardware components are highlighted in circular callouts, including the Baby-LIN-II transceiver, the Baby-LIN-RM-II evaluation board, and the Baby-LIN-MB-II Multi-Bus-Gateway. The background includes a server tower labeled 'Windows or Linux' and a SIMATIC 57-1200 PLC. Text elements include 'I/O Digital' and 'RS-232' with corresponding icons.

Distribution China: Hongke Technology Co., Ltd  
 Distribution USA: FEV North America Inc.

Ph: +86 400 999 3848  
 Ph: +1 248 293 1300

sales@hkaco.com  
 sales@dgeinc.com

www.hkaco.com  
 www.fev.com

Lipowsky Industrie-Elektronik GmbH Ph: +49 6151 935910

info@lipowsky.de

www.lipowsky.de



## References

- [1] BOSCH–CAN Specification Version 2.0, Robert Bosch GmbH, Stuttgart, Germany, 1991. [Online]. Available: <http://www.bosch.com>
- [2] SAE J2284-3, High-Speed CAN (HSC) for Vehicle Applications at 500 KBPS, 2002.
- [3] Kurachi, R., Takada, H., Nishimura, M., and Horihata, S., “A New High-Speed Bus Topology LAN Protocol Compatible with CAN,” SAE Technical Paper 2011-01-1043, 2011.
- [4] H. Mori, N. Maeda, S. Fukui, and H. Goto, “Optimization method for signal integrity of automotive LAN,” EMC Europe 2011 York, pp. 762 – 767, 26-30 Sept. 2011.
- [5] W. Lawrenz and D. Bollati, “Validation of in-vehicle-protocol network topologies,” Second International Conference on Systems (ICONS’07), pp. 24-28, 2007.
- [6] W. Prodanov, M. Valle, and R. Buzas, “A Controller Area Network Bus Transceiver Behavioral Model for Network Design and Simulation,” IEEE Transactions on Industrial Electronics, vol. 56, pp. 3762 – 3771, 2009.
- [7] Y. Chen, R. Kurachi, G. Zeng and H. Takada, “Schedulability Comparison for CAN Message with Offset : Priority Queue Versus FIFO Queue”, 19th International Conference on Real-Time and Network Systems, Nantes, France, Sep 2011.
- [8] K. Tindell, A. Burns, and A. Wellings, “Calculating controller area network (can) message response times,” Control Engineering Practice, 3(8), pp.1163–1169, 1995.
- [9] T. Sekiguchi, M. Horiguchi, T. Sakata, Y. Nakagome, S. Ueda, and M. Aoki, “Low-noise, high-speed data transmission using a ringing-canceling output buffer,” IEEE Journal of Solid-State Circuits, vol. 30, pp. 1569 – 1574, December 1995.
- [10] T. Gerke, and D. Bollati, “Development of the Physical Layer and Signal Integrity Analysis of FlexRay™ Design Systems,” 2007 World Congress, Detroit, Michigan, April 16-19, 2007.
- [11] FlexRay Consortium, “FlexRay Communications System Electrical Physical Layer Application Notes Version 3.0.1,” October 2010. International Organization for Standardization, Road vehicles .Controller area network (CAN). Part1: Data link layer and physical signaling, ISO IS11898-1 (2003)
- [12] Robert Bosch GmbH, “CAN with Flexible Data-Rate White Paper Version 1.1,” 2011.
- [13] F Hartwich, “CAN with Flexible Data-Rate.” International Cellulose Conference (ICC2012), Sapporo, Japan, 10-12 Oct. 2012.
- [14] T. Ziermann, S. Wildermann, and J. Teich, J, “CAN+: A new backward-compatible Controller Area Network (CAN) protocol with up to 16x higher data rates,” Design, Automation & Test in Europe Conference & Exhibition, 2009. DATE ‘09, pp. 1088 – 1093, 20-24 April 2009.
- [15] G. Cena and A. Valenzano, “FastCAN: A high-performance enhanced can-like network,” IEEE Trans. Ind. Electron., vol. 47, no. 4, pp. 951–963, Aug. 2000.
- [16] H. Mori, Y. Suzuki, N. Maeda, H. Obata, and T. Kishigami, “Novel Ringing Suppression Circuit to Increase the Number of Connectable ECUs in a Linear Passive Star CAN,” EMC Europe 2012 Rome, 17-21 Sept. 2012.

controller. It was applied to a transmitting node and a receiving node, and verified the communication establishment under the number of connectable nodes.

When using CAN transceivers without RSC, the ringing convergence time is 770 ns, so it satisfies the criterion of the arbitration phase. On the other hand, when the prototype CAN transceivers are used with integrated RSC are applied to the same network configuration, the ringing convergence time is 297 ns, which means it is reduced by 473 ns. When using conventional CAN transceivers, ringing does not converge by the criterion time, and it interferes to the next dominant bit. As a result, the evaluation board detects a communication error and outputs an error frame. Therefore, it is impossible to have an error-free communication. On the other hand, when using prototype CAN transceivers with RSC, the ringing convergence time is 300 ns. As a result, the ringing convergence time satisfies criterion and enables communication under the network configuration with eight connected nodes.

Figure 8 shows the largest network configuration using conventional CAN transceivers. Figure 9 shows the reception wave pattern of the data phase. When using conventional CAN transceivers, because the ringing convergence time is 392 ns, CAN FD communication is established. However there are not enough margins to increase the number of the connected nodes. ◀

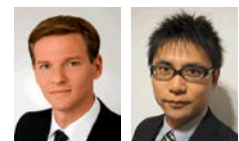

### Author

Tobias Islinger  
 Yasuhiro Mori  
 Denso Automotive Deutschland GmbH  
[www.denso-europe.com](http://www.denso-europe.com)





# All you need for CAN

HMS offers one of the largest portfolios of products and services for CAN

## Anybus CompactCom™

Multi-network connectivity for your device – as chip, brick or module

- Integrate Anybus CompactCom into your device to make it communicate with CANopen or any other network

## Anybus X-gateway™

- Connect any two industrial networks. More than 250 network combinations for fieldbus and Ethernet
- Easy configuration – no programming!

## IXXAT CM CANopen

CANopen PLC extension

- Extend your SIMATIC® S7-1200 to communicate with CANopen-based devices
- Proprietary protocols supported by additional transparent CAN 2.0A mode

## Anybus Communicator™

Your external businterface

- Connect a CAN-based device to any fieldbus or industrial Ethernet network – no changes to your hardware required and no programming!

## IXXAT PC/CAN Interfaces

- Easy connection of CAN or CAN FD systems to your computer – for control, analysis and configuration
- All common PC interface standards supported

## IXXAT CAN Repeaters and Bridges

- Increase the system reliability, implement line protection and save costs due to simple wiring
- Perform large distance bridging via Bluetooth/Ethernet

## IXXAT Protocol Software

- Use proven and tested IXXAT software stacks to run applications on CANopen, DeviceNet and SAE J1939
- Highly flexible protocol implementation for various microcontrollers/compilers

## IXXAT Controllers – Econ Series

Stand-alone embedded PC with multi-protocol support

- Control your system or setup gateways by using a platform providing a unique number of interfaces – analog/digital IO, fieldbus, industrial Ethernet
- Easy programming via Soft-PLC or Application Development Kits

## Netbiter

- Remotely monitor and control your CAN-based field equipment – anytime, anyplace!

## Service makes the difference

Our solution centers in Halmstad (Sweden) and Ravensburg (Germany) adapt our products to meet your requirements and deliver ready-to-go OEM solutions.

# CANopen Safety in mobile machinery

*The demand of exchanging information in mobile machines increases constantly. More sensors provide a broader and more precise feedback. All this information must be made available at places of the machine and to the outer world.*

For many years, communication in mobile machines was dominated by either CANopen or the CAN-based J1939. Two major trends have made it necessary to look over the fence and consider alternatives at least for a part of the communication tasks. One is the requirement of safe communication for safety functions set forth in the EN ISO 13849 and detailed in revised C- standards. The other one is the increasing volume of data, which can be logging data, data for different setup conditions or simply for much bigger PLC programs. Which role can CANopen Safety play to support these demands and what are its limitations?

## Allocation of roles

With the increasing number of tasks and requirements it becomes necessary to allocate the right bus system at an early stage. Especially as nowadays more options than just CANopen and J1939 for communication are available. More and more mobile machines utilize Ethernet and USB besides CAN-based communication. Now, what does a typical allocation of communication tasks look like?

CANopen still plays the leading part in cyclic communication between sensors, actuators, nodes, and the PLC as long as no safety functions are involved. Furthermore the communication between PLCs (cross communication) and from PLC to displays is CANopen-based. The bandwidth for this kind of communication is sufficient,

the availability of CANopen components meeting mobile machinery requirements is unsurpassed, it is widely spread and well known in the industry, and the protocol has proven its robustness.

CANopen Safety comes into the picture if safety functions are involved which cannot be addressed by CANopen. Although the data throughput is limited compared to CANopen due to the two data frames being sent instead of one, CANopen Safety has become the standard in safe communication in mobile machines. Meanwhile other alternatives of implementing safe communication via CAN have become available. Although they may have their advantages in some areas, one important point is missing. As these approaches are proprietary, the opportunity of selecting the best product from different vendors for a specific task got lost. In contrast, CANopen Safety has become a per se standard in safe communication of mobile machines, as no other safe fieldbus provides a broader range of mobile suitable sensors, joysticks, and PLCs.

Ethernet addresses the increasing need for non-cyclic data exchange in many fields. It is the bus-system which allows a fast data transmission to or from remote servers via router. But which kind of data is suitable for Ethernet communication? Firstly, Ethernet is a preferable way to load firmware, application programs, and graphical data to PLCs and displays. It is faster and more convenient than CAN and especially as the still used EIA 232. Secondly, mobile machinery

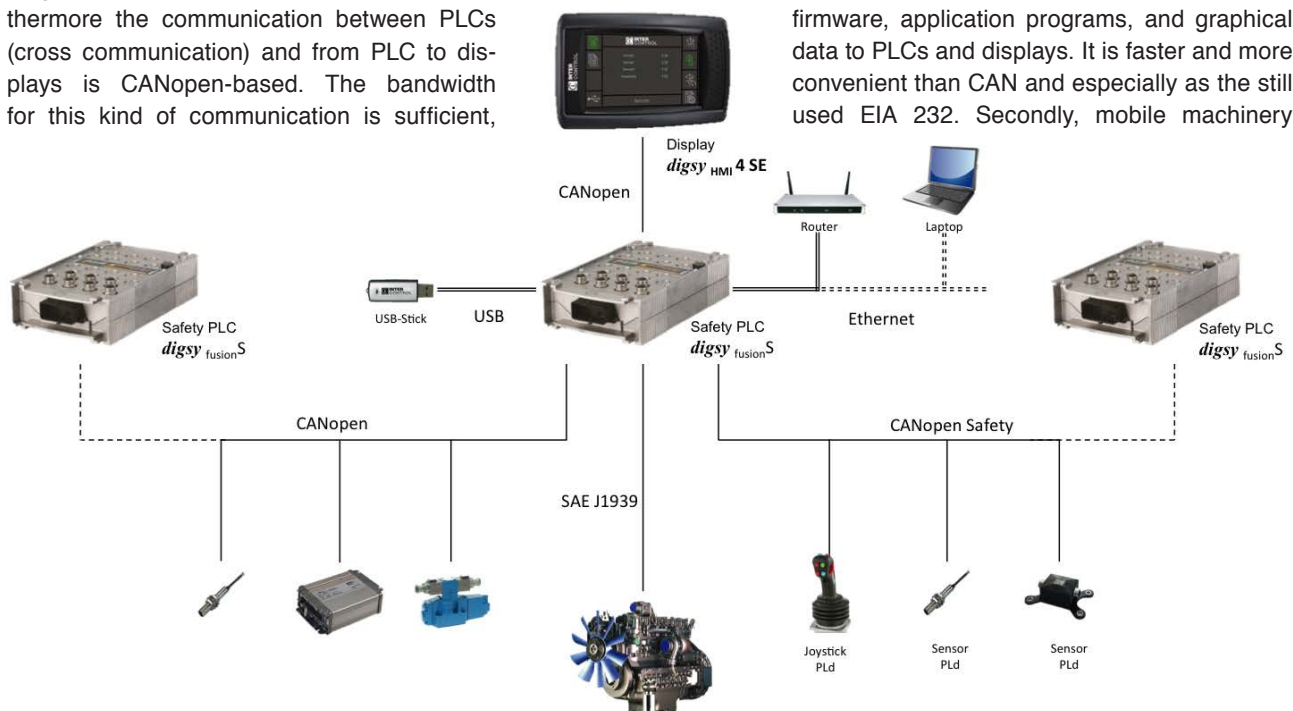

Figure 1: Exemplary communication architecture for mobile machines (Photo: Inter Control)

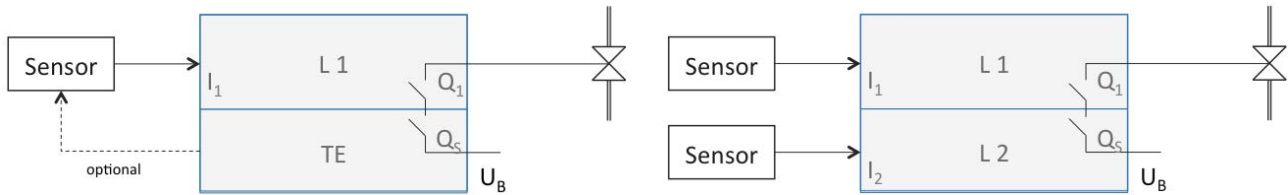

Figure 2: Category 2 and Category 3 according to EN ISO 13849 (Photo: Inter Control)

has an increasing need for set values addressing different machine modes and different set up conditions. These set values are provided as recipes, load moment tables, coordinates or others and can add up easily to more than 1 MiB.

Thirdly, mobile machines gather more and more data. Either to log their own conditions over time in PLC-based error or data log books to support technical analysis, or to collect data about the working process and to document the result of their job and to provide data for commercial statements. All this data has to be forwarded continuously or at a certain event to a database for further handling. Giving the increasing size of the collected data, CAN will be too limited for this job in more and more cases.

Although USB is not a common communication network on mobile machines, it can be a suitable interface for providing data to or gathering data from the machine. While Ethernet always requires some settings to establish the communication, a USB stick can easily be connected to a PLC or display without special preparation on the machine. The data sent or received from the machine typically has the same characteristics as the data communicated via Ethernet. With the opportunity to define the desired data exchange between PLC and USB-stick by script, mal-operation can be reduced significantly.

This allocation of tasks within the communication of mobile machines can lead to the exemplarily architecture that is shown in Figure 1. To enable such a communication structure, safety PLCs like the digsy fusion S provide four CAN networks with CANopen Safety, CANopen, J1939 or CAN protocol. Each protocol can be configured at each CAN network. Furthermore Ethernet, USB, and EIA 232 are available.

### Separation of safe and non-safe programs

As CANopen Safety is based on CANopen, CANopen users can adopt it relatively quickly. Nevertheless, implementing safe communication and safe functions in a machine control system goes hand in hand with restrictions and extra effort in programming, testing, and documentation as defined in the V-model of the IEC 61508.

To reduce this extra effort to the necessary minimum, Inter Control's safety PLC digsy fusion S provides the opportunity to run two application programs – one safe and one non-safe. As a key functionality, the digsy fusion S separates the non-safe program from the safe program in a way that stops the non-safe program from interfering with the safe program. Now it is possible to limit the effort of safe programming, testing, and documenting to the safe functions by concentrating them in the safe application program. All non-safe functions on the other hand should be realized in the non-safe application program – with reduced effort.

In the digsy fusion S, all CANopen Safety messages are sent to the safe program. Although CANopen Safety should be used for communication related to safety functions, this information might also be needed by the non-safe program. Via an implemented interprocess communication, this data can easily be made available for the non-safe program.

### Cross communication

Beside the classic communication between PLC and sensor or PLC and node, it might be necessary to establish a safe communication between PLCs. The digsy fusion S supports this so-called cross communication. To set up a cross communication, one PLC has to be configured as a CAN master while the other PLC has to be configured as a CAN slave. Regarding the communication, this PLC configured as a CAN slave behaves like a CAN node, but from the control perspective it maintains its entire functionality as a PLC. This master slave architecture can be extended with more PLCs configured as slaves.

Depending on the requirements of machine specific C-level standards or due to the result of a safety analysis, it could be necessary to realize a safety function as a Category 3 architecture according to EN ISO 13849 (Figure 2). CANopen Safety sends one data object with two data frames, where the second data frame is bitwise inverted and has a different CAN-ID than the first data frame. Due to this and further measures, the protocol itself supports Category 3 requirements. Besides the protocol, the hardware must be designed to meet Category 3 requirements as well. This could be realized e.g. by two CAN receivers where each receiver handles one of the two data frames. The digsy fusion S provides such means and is therefore able to process CANopen Safety messages according to Category 3 or Category 2 requirements. ◀



#### Author

Alexander Holler  
Inter Control  
[Holler.Alexander@intercontrol.de](mailto:Holler.Alexander@intercontrol.de)  
[www.intercontrol.de](http://www.intercontrol.de)

# Bringing flexibility to E/E architecture



(Photo: Gigatronik)

*Process stages in the agricultural- and construction-machinery industry are becoming more and more optimized and assisted. Technical implementation requires the use of the most advanced electronics.*

Machinery manufacturers are working together with Gigatronik to develop new hardware and software concepts. The intention is to implement the latest and future functions by using a unified electrical/electronic (E/E) platform strategy to ensure future-proofing through flexibility and modularity.

One real challenge for manufacturers of industrial machinery is the small number of vehicles sold per year. This means that development costs are spread over relatively few control units. For this reason, a key requirement of the project is to develop an electronics concept that is suitable for cost-sensitive machines yet at the same time can be modularly extended for use in complex machines. A single control unit cannot meet these requirements, which is why Gigatronik has developed a concept for extending E/E architecture on the basis of a motherboard. The E/E architecture can be scaled according to the equipment configuration and machine type.

The concept involves a motherboard and an add-on module (Figure 1). The motherboard covers the basic functions of a machine, providing a cost-optimized control unit. For more complex machines, add-on modules that are output- or input-optimized can be used. For very complex machines, more control units can be connected via the CAN network to extend the inputs and outputs for hydraulic functions, for example. This concept also has the side effect of creating potential for the optimization of the cable harness.

## Scalable E/E architecture

To meet the requirements for scalability, a control unit was developed that provides the required number of inputs and outputs for small, cost-sensitive machines. This control

unit acts as a central master control unit that always has to be present in the architecture and provides the gateway for Isobus (Figure 2).

Larger machines require more inputs and outputs. These can be connected via I/O extenders on the central master control unit. A special feature here is the presence of the two redundant extension CAN networks: "IO-CAN Master 1 Left" and "IO-CAN Master 1 Right" (Figure 3). While the hydraulics for important system features can be directly connected to the central control unit, the low priority functions can be swapped out to the left and right I/O networks. In this case, even if the network is severely damaged, it is still possible to work with the main features.

The means of extending the E/E architecture described above provides scalability in terms of inputs and outputs. The architecture can also be extended in terms ▶

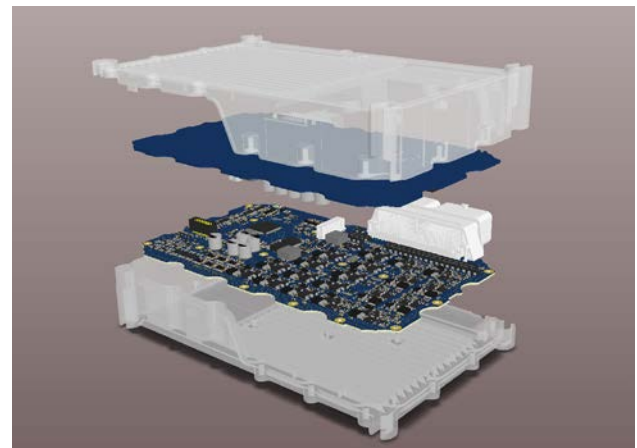

Figure 1: The modular construction of the control units allows the E/E architecture to be tailored to the different complexities of machines (Photo: Gigatronik)

— ISOBUS — Master 1

Figure 2: Central master control unit for basic machines  
(Photo: Gigatronik)

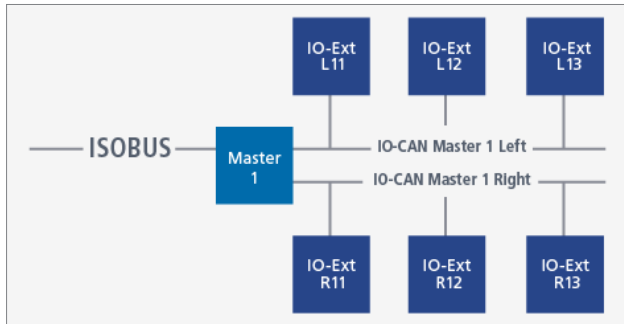

Figure 3: Master control unit extended using I/O extenders  
(Photo: Gigatronik)

of application performance, and this is done by extending the application bus. This allows application elements to be distributed across the master control units at will (Figure 4). Extensive simulations have been performed to assure the maximum bus load. In these, the bus utilization is measured for a given number of I/O extenders and cyclical update rates for process data. These data are stored in a CAN database. Gigatronik has developed a tool that generates the CAN interface layer as C source code from the CAN databases. This ensures synchronization between simulation and reality.

## Systems engineering

The V-Model is a structured development method for tasks of this complexity. It is widely used in joint development projects. It uses tried-and-tested development methods, and these are applied by Gigatronik: requirements engineering, model-based software development, Autosar-layered basic software, a generic hardware design with a motherboard and add-on module, UDS-on-CAN diagnostics, assurance by testing (MIL, SIL, and HIL).

Automotive Open System Architecture (Autosar) is the de-facto standard for software architecture in the automotive sector. In it, the application layer is always separated from the basic software layer by middleware. This creates three software layers:

- ◆ Software components on the application level that can be applied across multiple control units,
- ◆ Basic software modules (drivers, services, operating system, I/O hardware abstraction, for example),
- ◆ The runtime environment as an interface between application and basic software.

With this technology, the basic software modules can be developed once and used over and over again, saving on development costs. Depending on the E/E architecture chosen, the software components can be applied across various control units. This allows the number of control units required to be varied in a cost-effective way.

# All you CAN plug



CANopen®

CAN<sup>FD</sup>

## CAN-PCI/402 CAN-PCIe/402

- up to 4 high performance CAN interfaces powered by esd Advanced CAN Core (ACC)
- DMA busmaster and MSI support
- High resolution hardware timestamps

## CAN-USB/400

- 2 high performance CAN interfaces powered by esd Advanced CAN Core (ACC)
- CAN error injection capabilities
- High resolution hardware timestamps
- IRIg-B time code option

The esd Advanced CAN Core (ACC) powered CAN/400 board series is also available in CompactPCI, CompactPCISerial, PMC, XMC and µTCA form factors.

## Operating Systems

esd supports the realtime operating systems VxWorks, QNX, RTX, RTOS-32 and others as well as Linux and Windows 32/64 Bit systems.

## CAN-Tools

Our efficient CAN monitoring and diagnostic tools for Windows like CANreal, COBview, CANplot, CANscript and CANrepro are delivered together with the Windows/Linux driver CD free of charge or can be downloaded at [www.esd.eu](http://www.esd.eu).



Hall 5, booth 169  
in Nuremberg 23.-25.02.2016



Hall 9, booth F17  
25.-29.04.2016



esd gmbh  
Vahrenwalder Str. 207  
30165 Hannover  
Germany  
Tel.: +49-511-3 72 98-0  
info@esd.eu  
www.esd.eu

US office:  
esd electronics, Inc.  
70 Federal Street - Suite #2  
Greenfield, MA 01301  
Phone: 413-772-3170  
us-sales@esd-electronics.com  
www.esd-electronics.us

www.esd.eu

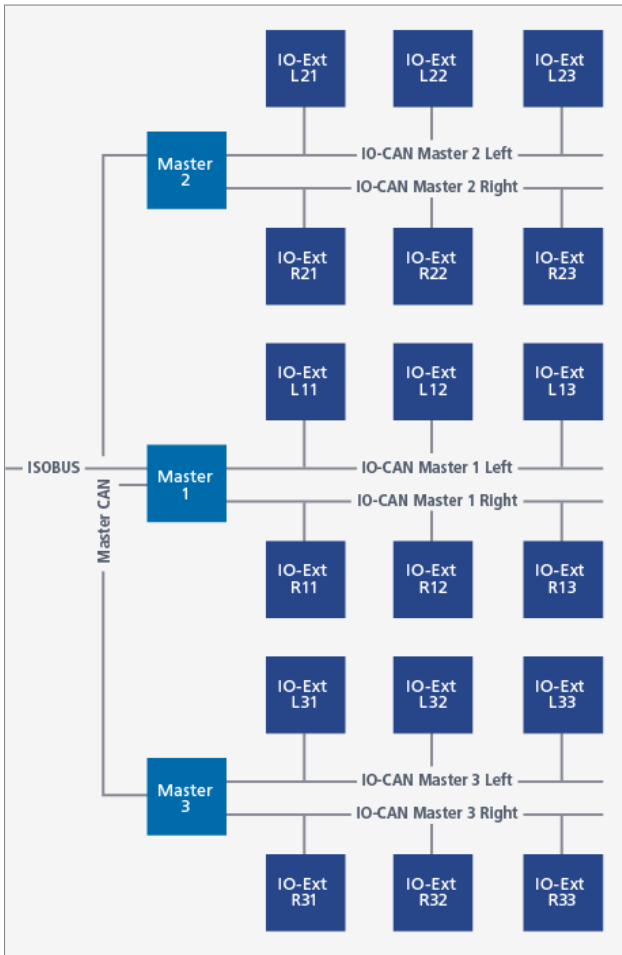

Figure 4: Architecture extended with application elements and I/O extenders (Photo: Gigatronik)

However, for some customers in the agricultural- and construction-machinery field, the usually high level of complexity of this architecture is not necessary. This is why Gigatronik offers an own implementation of the basic software layer. The accesses to the hardware and the layer model are similar to Autosar but for example the communication layer is simplified. This results in a simple structure that can be configured even without expensive software tools.

The implementation of new features is particularly complex in the world of agricultural engineering, often requiring expertise in hydraulics, control technology, electronics, and programming. A model-based development process lowers the hurdle for implementing a new feature in an electronic system. It allows control-technology experts to implement functions in Matlab/Simulink without having to get a deeper understanding of hardware or software characteristics. New functions can be tested as

**Related articles**

- ◆ [Alexander Ostermüller \(John Deere\), Peter Fellmeth \(Vector\): Isobus testing with implement and remaining bus simulations](#)
- ◆ [Holger Zeltwanger \(CiA\): Farming with passion: CAN is set](#)
- ◆ [Holger Zeltwanger \(CiA\): Isobus – the CAN-based network system for agriculture and forestry machines](#)

**CAN Newsletter Online**

The CAN Newsletter Online sister publication provides brief product-related information. For more details please visit [www.can-newsletter.org](http://www.can-newsletter.org).



Agritechnica 2015  
**Isobus terminal and weather station**

At the Agritechnica fair in Hanover, Germany, Mueller Elektronik presents besides other products, the Smart430 Isobus terminal as well as its Isobus weather station.

[Read on](#)



Crop sensor  
**Isobus certified by AEF**

Claas (Germany) has developed the Isaria crop sensor featuring a CAN interface compliant to ISO 11783 (Isobus).

[Read on](#)



Agritechnica 2015  
**Automation for agricultural technology**

At this year's Agritechnica, Jetter (Germany) presents a select portfolio of scalable automation solutions for agricultural implements.

[Read on](#)



Isobus conformance test  
**For farm management information systems**

At Agritechnica 2015, the Agricultural Industry Electronics Foundation (AEF) presents a prototype of the Isobus conformance test for farm management information systems (FMIS).

[Read on](#)



Isobus terminal  
**Precision agriculture is calling**

Kverneland Group has extended its range of universal Isobus terminals with the Isomatch Tellus GO. This one-screen terminal was developed for the control of any Isobus implement.

[Read on](#)

prototypes on a computer or HIL test bench. The source code is generated from the model and automatically integrated into the existing basic software. By using the latest development methods, OEMs in agricultural machineries are now able to use an E/E architecture tailored to the equipment configuration. ◀



**Author**

Dr.-Ing. Stefan Nagel  
Dipl.-Ing. (FH) Thomas Bückle  
Dipl.-Ing. (FH) Martin Werz  
Gigatronik  
[tech@gigatronik.com](mailto:tech@gigatronik.com)  
[www.gigatronik.com](http://www.gigatronik.com)

ifm electronic



# Look what we have for you!

An absolute must-have!

**ecomatmobile BasicController<sup>relay</sup>**: modular mini controller with powerful relay outputs with diagnostic capabilities for mobile applications. Direct connection of sensors and actuators without further external wiring, powerful CAN interfaces, programmable to IEC 61131-3 with CODESYS. Can be extended with other components, such as the BasicDisplay. With E1 type approval of course.



[www.ifm.com/gb/ecomatmobile\\_basic](http://www.ifm.com/gb/ecomatmobile_basic)

Phone: +49 0800 16 16 16 4



(Photo: Epec)

## Partners in agriculture machines

*Epec is specialized in electronics for off-highway and off-road vehicles. It supplies its CANopen products also for farming equipment. Recently, the CiA member has launched Isobus support.*

The Draco seeder by Tume-Agri, introduced last year, is equipped with two 3606 control units and the 6107 display unit by Epec. On a single screen the operator can view the machine's operating system and follow live camera feed of the seeding process transmitting from cameras located at the back on both sides of the machine. Previously, doing the same thing required two different displays, which meant an investment of over 2000 €, explained Tume-Agri Development Manager Heikki Sola. The CANopen-based control system has enabled the seeding machine to have an added feature alongside already existing ones – splitting the machine.

With a push of a button, the operator can choose whether the 4-m wide machine sows at only a 2-m width, to the machine's left or right side. For example, at the end of a field, splitting the machine provides a clear benefit in terms of cost savings and environmental savings, because the area to be fertilized is optimized correctly, Heikki Sola continues.

For Tume-Agri, the partnership with Epec has offered a chance to respond to the development pressures brought

on by the Internet of Things (IoT). Already, agricultural machinery requires diverse electronic management. In the future, they must be flexibly adjustable in terms of different development needs. Epec's know-how of producing scalable control systems and control devices for demanding circumstances assured us, acknowledged Heikki Sola. "The cooperation with Epec has served both us and our clients. We are now able to offer our clients a machine that you can operate and monitor simultaneously from just one display, which also has the capability to make use of the technology of the future, as well as have lower manufacturing costs than before," said Kari Sutinen from Tume-Agri.

Epec headquartered in Seinäjoki (Finland), a long-time CiA member, has provided CANopen-connectable 3606 host controllers programmable in IEC 61131-3 languages for many years. The robust, leak proof zinc/plastic housing has been tested against different environmental conditions. Also, the shape of the casing works to protect the electronics inside against mechanical wear. Three-point fixing confirms firm mounting also on irregular surfaces.



The control unit has a number of both input and output pins. This includes 3606 controllers providing eight PWM outputs. The total number of I/O pins is 21, including digital inputs and outputs, analog inputs, pulse inputs, proportional (PWM) outputs, and current feedback inputs. The design of the robust unit carries features such as signal LED for control unit diagnostics. One CAN interface is equipped with double pins, which makes cabling easier since there is no need for branches in the wire harness. A second CAN port is also available as an option. Epec will show these CANopen devices and other products at Bauma 2016 in Munich (Germany) on its booth in hall A5, stand 313.

## Isobus support and remote management service

At the Agritechnica 2015 tradeshow in Hanover (Germany), Epec announced the support of the ISO 11783 compliant communication interface in its control units. ISO 11783 is a CAN-based higher-layer protocol using the same communication methods as defined in SAE J1939 with some extensions. The interface is also known as Isobus, when it is conformance tested according to the AEF specifications. The purpose of Isobus is to provide interoperability between tractors and implements from different manufacturers and enable the use of a single Virtual Terminal (VT) for all implements. A typical Isobus system consists of a VT unit, Task Controller (TC), Tractor ECU (TECU), and Implement ECU (I-ECU).

“Our main focus with the Isobus solution is going to be on the implement control systems and I-ECU functionalities. We are able to offer a complete package for the implement control system development,” explained Marjo Takkula, Product Manager of software products from Epec. The following products are under development and will be launched in summer 2016:

- ◆ Isobus and SAE J1939 libraries to take care of the Isobus communication between implement and tractor;
- ◆ Multi Tool for configuration of the implement control system including the Isobus communication;
- ◆ CANmoon application to create and download VT object pool binary together with Codesys applications to ECUs;
- ◆ Isobus implement ECUs (Epec 3000/4000 series) providing a Codesys runtime software;
- ◆ The Isobus library will include a protocol stack (ISO 11783-3), the network management (ISO 11783-5), a VT client (ISO 11783-6), the implement application profile without tractor control commands (ISO 11783-7), the TC client (ISO 11783-10), and diagnostics services (ISO 11783-12).

Additionally, the Finnish company launched in Hanover its GlobE remote management service for OEMs and machine/fleet owners to remotely access the machine data. The customer need for remote management has increased significantly. The GlobE



Figure 1: Remote access unit with CANopen and SAE J1939 support (Photo: Epec)

## CAN Newsletter Online

The CAN Newsletter Online sister publication provides brief product-related information. For more details please visit [www.can-newsletter.org](http://www.can-newsletter.org).



### Agritechnica 2015 *Agricultural machinery innovations*

Innovations in agricultural machinery and equipment and the latest solutions and concepts for the future of plant production are presented every two years at Agritechnica.

[Read on](#)



### Agritechnica 2015 *Universally usable operating and display unit*

At the Agritechnica 2015, Bosch Rexroth presents its universally usable Bodas DI4 display. It is suitable for modern operating concepts with service functions in mobile working machines.

[Read on](#)



### Agritechnica 2015 *Automation for agricultural technology*

At the Agritechnica 2015, Bosch Rexroth presents its universal. At this year's Agritechnica, Jetter (Germany) presents a select portfolio of scalable automation solutions for agricultural implements.

[Read on](#)



### Isobus conformance test *For farm management information systems*

At Agritechnica 2015, the Agricultural Industry Electronics Foundation (AEF) presents a prototype of the Isobus conformance test for farm management information systems (FMIS).

[Read on](#)

service, together with the company's 6000 series product family, offers machine manufacturers a way to connect their machines to the Internet. The service provider takes the overall responsibility of the system from the sensor to the Cloud.

The hardware base is the 6100 remote access unit, coming in a fully enclosed aluminum housing. It is equipped with a built-in 2G/3G/GPS interface, which allows connecting the mobile machinery to the internet. The IP66-rated remote access unit together with the Multi Tool and the Codesys 3.5 programming environment makes it easy to integrate machine control system with higher-level information systems and industrial internet solutions, such as the GlobE service. The CAN interface supports CANopen as well as SAE J1939.

## Author

Holger Zeltwanger  
CAN in Automation  
[headquarters@can-cia.org](mailto:headquarters@can-cia.org)  
[www.can-cia.org](http://www.can-cia.org)



# From line topology to star repeater

*When a CAN system reaches some level of extent, a reasonable wiring scheme becomes an issue. Typically, nodes all over the machine have to be addressed from a central control cabinet.*

As CAN is designed for a line topology system, integrators have to find a track through the system which does not violate their margins for length and costs. Seeing this problem, EMS Dr. Thomas Wünsche developed a concept for a CAN star repeater. The concept became a product, triggered by a customer who was in search of an improvement of the CAN wiring in their plastic film extrusion machine. In the beginning a fundamental analysis of the wiring possibilities was necessary. It became obvious that the wiring can be done in three fundamentally different ways.

## Classic line topology

In the classic line topology all CAN nodes are connected to a single trunk. This method is wide-spread and has its value for small installations, based on its relatively low costs. Nevertheless there are serious disadvantages. The whole system will go down in case of a single failure like a broken line or a non functional node, sending a permanent dominant signal. Additionally, it is possible that there is a need to extend the system with the integration of further nodes. Usually this is not an easy task with an existing line topology. The length of the line may exceed the allowed maximum for the given bit rate when loops are introduced to connect the additional nodes. Some of these problems can be solved using standard repeaters.

## Star-wiring with standard repeaters

Characteristic for star-wiring with standard repeaters is the connection of stub lines with CAN repeaters to one main trunk. In the stub segments, many nodes can be connected. This is a solution for some problems of the classic line topology. The use of repeaters permits long stubs, which can lead to a smaller total network. Furthermore the subsequent integration of further CAN nodes like sensors and actuators is eased. In addition the stability of the overall system is increased, because the breakdown of one segment has no effect on the communication of the remaining system.

Moreover the segmentation of the system simplifies trouble shooting, which increases the up-time of the station. Nevertheless this is still not the optimal solution. On one hand the maximum propagation delay of two repeaters has to be used when determining the effective maximum length within such a system. This can cause problems with the chosen bit rate for extended installations. On the other

hand the costs for the use of many repeaters may exceed the given budget.

The customer of EMS Dr. Thomas Wünsche was using star wiring with standard repeaters. But costs let them search for alternatives. They found the solution in the star repeater CRep S8C. With the combination and implementation of the main trunk in a FPGA device, it became possible to integrate eight independent CAN segments in one device. This leads to the third possibility of wiring.

## Star-wiring with star repeaters

With this method a CRep S8C becomes the central point of the star topology. In addition to the advantages discussed above for the star-wiring with standard repeaters, the use of a dedicated star repeater offers its own improvements. The most obvious one is the significant reduction of segment costs, because one star repeater can replace up to eight standard repeaters. Also the integration of the main trunk in the device reduces the propagation delay between two segments nearly by the factor of 2 compared to a system using standard repeaters. An additional advantage is the increased flexibility of the overall system. It is possible to cascade up to three CRep S8C, which leads to a maximum of 24 physical CAN segments. Every channel can be plugged with its own 3-pin pluggable terminal block. A terminating resistor is integrated for every channel. This enables the connection and disconnection of CAN nodes without changing the rest of the system. ▶



Figure 1: The star repeater CRep S8C (Photo: EMS)

Star-wiring with star repeaters can be recommended for the following cases:

- ◆ If many CAN-nodes at different places of a system have to be connected;
- ◆ If line topology is not possible because of the expected extent of the system;
- ◆ If the network needs to be flexible for the addition of new nodes or segments;
- ◆ If parts of the system have to be available although segments of the system are permanently dominant.

Examples for this characteristics can be found in different branches such as mining, access control for e.g. camping sites, or construction of special machines. The company exhibits at the Embedded World fair in hall 1 / stand 640. ◀

#### Author

Dipl.-Ing. Gerhard Uttenthaler  
EMS Dr. Thomas Wuensche  
[sales@ems-wuensche.com](mailto:sales@ems-wuensche.com)  
[www.ems-wuensche.com](http://www.ems-wuensche.com)

## CAN Newsletter Online

The CAN Newsletter Online sister publication provides brief product-related information. For more details please visit [www.can-newsletter.org](http://www.can-newsletter.org).



### *UL-approved CAN infrastructure components*

The repeater, segment coupler, and bridge for CANopen and DeviceNet transmissions from Phoenix Contact are now UL approved.

[Read on](#)



### *CAN repeater with anti-noise circuit*

HMS Industrial Networks now launches CAN repeaters under the Ixxat brand.

These products enable coupling of two or more CAN network segments. The integrated galvanic isolation provides a built-in protection against over voltage and the anti-noise circuit of the units eliminates the effects of EMI (Electromagnetic Interference) like heavy noise on the CAN network.

[Read on](#)



### *CAN repeaters with fiber-optic converters*

Shenzhen Comark Technology (China) produces repeaters and hubs with

fiber-optic converters for several industrial communication systems including CAN-based networks. The products support CANopen, DeviceNet or J1939 as well as proprietary bit-timing specifications.

[Read on](#)

Interconnect your  
Innovations now!



# STW

## **ESX-TC3G** Connectivity and data management platform

- Freely programmable on Linux
- Expandable Software Modules/Apps
- Cumulocity Cloud Data Connector
- 400MHz CPU, 128 MB RAM
- 3G, GPS/GLONASS, WLAN, BT4.0
- 2x CAN, RS232, USB, Ethernet

### Exhibition Dates



**Bauma, Munich**  
11.04. – 17.04.2016  
Hall A5, Booth 125



**Hannover Messe, Hanover**  
25.04. – 29.04.2016  
Hall 11, Booth F43 and  
Hall 13, Booth C16

## Customized ICs reduce costs

*In automotive electronics, there is a trend towards application-specific chips. OEMs and Tier-1s increasingly use FPGAs, ASICs, and other customized ICs, in order to make ECUs and system design more efficient.*



*Customized ICs are gaining market shares in automotive electronics: They are cost-effective and provide an optimized low-power consumption (Photo: Altera)*

Nowadays, about one fourth to one third of the car production costs are related to electronics. More importantly, automotive electronics contribute 90 % of the innovation. This includes safety systems, entertainment, and emission reduction as well as the upcoming autonomous driving functions. The annual average growth rate was about 7 % in the last years. Market researchers predict 179 billion € worldwide turnover for automotive electronics for 2017. Radiant Insights (USA) expects in its [“Global automotive electronic control unit \(ECU\) market size”](#) report an annual growth rate of six percent. In 2022, the ECU market will exceed 45 billion US \$.

### **ECUs for passenger cars as well as for commercial and utility vehicles**

The automotive ECU market can be segmented based on type, application, and technology. Based on type, the market can be segmented as utility vehicles, commercial vehicles, and passenger cars. Of course, the requirements for

ECUs are different. High-volumes are used in passenger cars, while ECUs for commercial and utility vehicles are produced in lower quantities.

Based on technology, the market can be further segmented as transmission control, engine management, anti-lock braking system, climate control, power steering, airbag restraint system, and body control system. On the basis of application, the market can be categorized in communication and navigation systems, entertainment systems, powertrain electronics, chassis electronics, and safety as well as security systems. The safety and security segment is anticipated to be the highest. Communication and navigation systems are likely to exhibit high growth owing to rising demand for comfort characteristics.

Nearly 100 % of these ECUs are connected to in-vehicle networks. CAN is still the most used communication technology. CiA estimates for 2016 the installed number of CAN interfaces close to one billion. Most of the CAN-connectable ECUs are equipped with micro-controllers with ▶

20+ years

Membership

on-chip CAN modules. CAN stand-alone controllers are used rarely, e.g. for some tools and some other low-volume applications. CAN is also implemented in several customized ICs (integrated circuit) such as System-on-Chip (SoC), application-specific standard product (ASSP), or application-specific integrated circuit (ASIC).

Customized circuitries become increasingly popular in ECU design. In order to simplify the design of ECUs with still increasing complexity, it is necessary to use application-optimized components. This keeps the chip costs tolerable. SoCs, ASSPs, and ASICs have a great future in automotive electronics. These products offer high-performance and low-power consumption, which is what the ECU makers like – and their customers as well. On the other hand, these chips are only partly programmable. This brings FPGAs (field-programmable gate arrays) into the game. For low-volume designs or for prototyping or for highly configurable devices, FPGAs are well suited. No surprise that after the CRC issue of the CAN FD standardization, it was quite easy for the FPGA vendors to update their silicon. Some of the micro-controller manufacturers are still working to migrate from the non-ISO to the ISO CAN FD protocol.

SoC-class FPGAs can comprise several processor cores including DSPs (digital signal processors), on-chip memory, dedicated logic circuitries, and CAN (FD) cores as well as transceiver blocks. There are also PSoCs (programmable system on chip) on the market: [Cypress](#) offers a hard-coded micro-controller core with programmable analog and digital parts. [Altera](#) and [Xilinx](#) provide similar solutions. The naming is not unified: some call those components CPLD (complex programmable logic device), PAL (programmable logic array), macrocell array, etc. The main players include Altera, [Atmel](#), [Cypress](#), [Lattice](#), and [Xilinx](#).

Automotive OEMs and Tier-1s use FPGAs and CLDPs to differentiate their ECUs and optimize them to their requirements on functionality and costs. Altera's automotive-grade portfolio of highly integrated Enpirion PowerSoC power management solutions features 45000 year mean-time between failures (MTBF) and delivers high efficiency in a tiny footprint to maximize power density, simplify design, reduce system cost, and minimize heat.

### Faster development cycles

There are three challenges, automotive ECUs designers have to face: faster development cycles, cost-effective development as well as meeting quality and safety requirements. The gap between consumer and automotive technologies has narrowed significantly with automotive innovations keeping pace with consumer, or in some cases, leading. For example, video analytics for driver assist systems rely on ultra-low latency precision algorithms to analyze real-time video feeds from a vehicle's cameras and make split-second decisions. System designers need to use the latest silicon to achieve these levels, but new ASIC/ASSP development schedules cannot keep up with the faster development cycles.

More and more system designers are using FPGAs for volume applications because of the following advantages they offer:

# Same Function Same API Same Tools

Future proof **communication solution** for **CANopen**, thanks to **Hilscher Platform Strategy**.

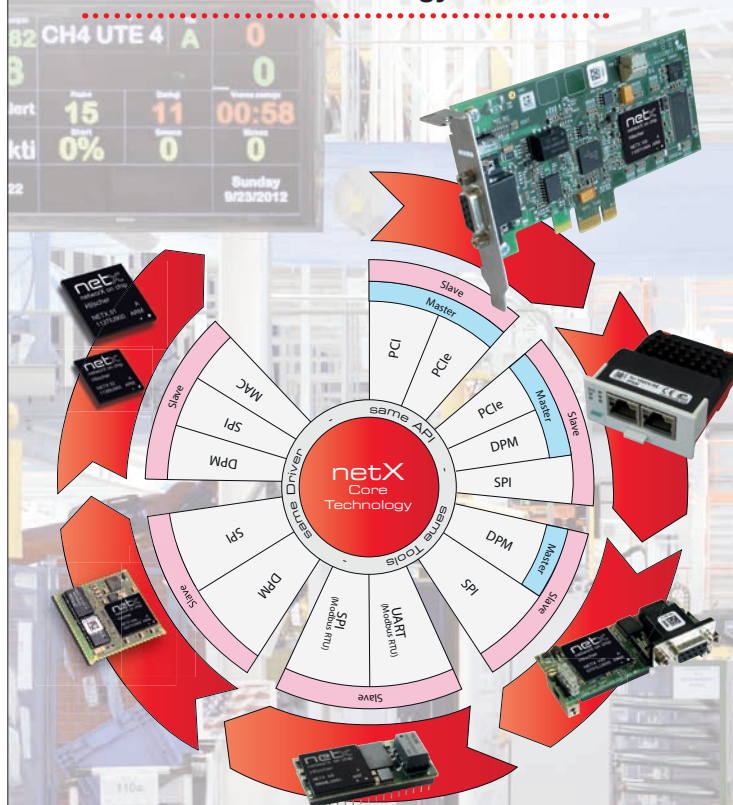

- ✓ **Shape-independent**  
From PC Card to ASIC
- ✓ **Network-independent**  
Fieldbus and Real-Time Ethernet
- ✓ **Hierarchy-independent**  
Master and Slave
- ✓ **Future proof**  
Migration without software modification
- ✓ **Secures investment**  
Substantial synergies and cost savings

**CANopen**®

**hilscher**  
COMPETENCE IN COMMUNICATION

[www.hilscher.com](http://www.hilscher.com)



- ◆ Shorter time to market compared to ASIC solution through re-programmability and reduced risk vs. an ASSP with the ability to fix bugs without a redesign;
- ◆ Do not go through the same time consuming physical design, design-rule closure, tape-out, and fabrication processes that ASICs do;
- ◆ Ability to make hardware changes available in FPGAs are not an option with ASSP and microcontroller unit (MCU) designs;
- ◆ Design software such as Altera's Quartus Prime speeds-up system design and take advantage of FPGA in-system verification to reduce debugging effort.

Automotive OEMs are struggling with the economic and logistic realities of differentiating vehicles across hundreds of models and options. Many recognize the need for a modular system design approach based on flexible platforms that are customizable across several vehicle models or grades (entry, mid, high, or luxury). They like to scale the size of the FPGA within the same package so that they can increase logic resources using the same board design. They also appreciate the support of multiple types of image, radar and laser sensors, and various network connectivity options like CAN (FD), Flexray, MOST (media-oriented system transport), and Ethernet AVB (audio/video bridging). Altera provides different customized IC solutions: MAX II CPLDs, Cyclone and MAX 10 series FPGAs, and Cyclone V SoCs with ARM-based hard processor system (HPS). The company guarantees to support the developed hardware for a minimum of ten years after release. "Our average product cycle is 15 years, with many of our products having lifetimes in excess of 20 years so you can design in our products with confidence," states the company on its website. "When change is absolutely mandatory, we take exceptional care to provide special product change notifications so you can manage the delicate roll-out of changes to your customers, the automakers, in a coordinated and well-orchestrated manner."

## Intel completed the acquisition of Altera

End of 2015, [Intel](#) announced that it has completed 16,7 billion US-\$ acquisition of Altera. This means Intel is back in automotive electronics. Back in the mid '80s, Intel was one of the first companies implementing the CAN protocol in its legendary 82526 stand-alone controller. The successor 82257, also a CAN stand-alone controller, was quite successful. But Intel decided in the '90s to focus on the PC business and stop the production of CAN products. Nevertheless, the 82257 is still alive: [Innovasic](#) offers the IA82527 CAN controller. It is a form, fit, and function replacement for the original Intel 82527 chip. This allows users to retain existing board designs, software compilers/assemblers, and emulation tools, thereby avoiding expensive redesign efforts.

The Altera acquisition complements Intel's product portfolio and enables new classes of products in the high-growth data center and Internet of Things (IoT) market segments as well as automotive electronics. "Altera is now part of Intel, and together we will make the next generation of semiconductors not only better but able to do more," said Brian Krzanich, Intel CEO. "We will apply Moore's Law

to grow today's FPGA business, and we'll invent new products that make amazing experiences of the future possible – experiences like autonomous driving and machine learning."

Altera will operate as an Intel business unit called the Programmable Solutions Group (PSG), led by Altera veteran Dan McNamara. Intel promised a smooth transition for Altera customers and will continue the support and future product development of Altera's many products, including FPGA, ARM-based SoC, and power products.

Altera cooperates with IFI (engineering office for IC technology) in respect to CAN FD cores for its customized IC business. The CAN-FD Mega Core for the German company supports the protocol as standardized in ISO 11898-1:2015 standard, released at the end of 2015. The core provides message transmit and receive buffers with capacity of up to 64 KiB each. The FIFO (first-in, first-out) buffers can be assigned dynamically to the message size. The core features 256 message filters, time-stamp functionality (captured at EOF and SOF), and an Avalon memory-mapped interface. It comes with software drivers. ▶

## CAN Newsletter Online

The CAN Newsletter Online sister publication provides brief product-related information. For more details please visit [www.can-newsletter.org](http://www.can-newsletter.org).



Cooperation

### Verification of CAN FD cores

Avery Design Systems, Rianta Solutions, and Cast have joined their forces to provide verified IP cores for CAN FD and other automotive networks.

[Read on](#)

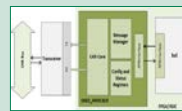

IP core

### Compliant with Arinc 825-1

Silkan (France) provides the D002\_Arinc825 core featuring the CAN protocol.

It can be integrated into FPGAs and ASICs.

[Read on](#)

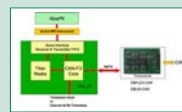

IP core

### Supports ISO and non-ISO CAN FD

IFI (Germany) provides CAN FD silicon implemented in different FPGAs from Altera. The user can switch between ISO and non-ISO mode.

[Read on](#)



CAN FD products

### Microchip goes automotive

Microchip has pre-announced its CAN FD stand-alone controller and transceiver.

Its daughter company, K2L has launched interface devices supporting CAN FD to be used with the company's software tools.

[Read on](#)

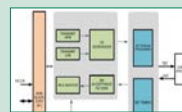

IP solution

### Non-ISO CAN FD core for automobiles

Arasan's Total IP Solution implements the Classical CAN protocol, as well as the non-ISO CAN FD protocol compliant to Bosch. The company plans the development of CAN FD transceivers, too.

[Read on](#)

## Xilinx supports the CAN FD core from Fraunhofer IMPS

Competitor Xilinx cooperates with [Cast](#) to provide a CAN FD core for its customized chips. Cast offers the CAN FD core developed by [Fraunhofer IMPS](#) (institute for photonic micro-systems). The CAN-CTRL core features programmable interrupts and bit-rates. The number of independently programmable acceptance filters is configurable. The core has a generic processor interface or comes optionally with an AMBA-APB interface. It implements a flexible buffering scheme, allowing fine-tuning of the core size to the requirements of each specific application. The number of receive buffers is synthesis-time configurable. Two types of transmit buffers are implemented: a high-priority primary transmit buffer (PTB) and a lower-priority secondary transmit buffer (STB). The PTB can store one message, while the number of included buffer slots for the STB is synthesis-time configurable (0 slots to 16 slots). Moreover, an optional wrapper instantiating multiple CAN controller cores eases integration in cases where multiple bus-nodes need to be controlled by the same host processor. The core implements functionality similar to the Philips SJA1000 working with its Peli CAN mode extensions, providing error analysis, diagnosis, system maintenance and optimization features.

Xilinx sells the CAN FD core, the Logicore IP, under two license agreements: The XA class components implementing the core and the non-XA class components for low-volume applications with less than 20000 pieces cumulative. If the volume of 20000 is exceeded, licensees must contact Bosch for an additional license. Bosch holds IP rights on the CAN FD protocol. The Logicore IP compensates three data-phase bit-times when falling back to the arbitration bit-time after the CRC (cyclic redundancy check) field. The implementation features 32 receive FIFO buffers with 32 filter-mask pairs. Cancellation of messages not yet transmitted is supported. Messages with the highest priority (lowest ID number) are transmitted first.

Cast representing Fraunhofer IPMS has teamed up with Avery Design System and Rianta Solutions to verify the CAN FD core. "We are excited to work with Avery to help automotive engineers develop safer systems quicker through the industry's first integrated CAN FD soft IP (intellectual property) core and VIP package," said Nikos Zervas, chief executive officer of Cast. The CAN FD core is available in synthesizable RTL for ASICs or FPGAs. A ready-to-run reference design board and other development aids are also available from Cast to further shorten the time-to-market for CAN FD based products. The Avery's Classical CAN and CAN FD verification tool complies with ISO 11898-1:2015. Models and compliance test-suites for all modes are supported. The verification tool is developed in native System Verilog UVM and includes traffic generation, protocol checking, and coverage.

Xilinx tests its automotive-grade components above and beyond the current AEC-Q100 automotive qualification requirements. The company has also completed design tool certification by a 3rd party for compliance to the ISO 26262 standard for functional safety. In today's automotive ▶

# POSITAL

## FRABA

### SENSORS FOR MOBILE MACHINES



### Absolute Rotary Encoders and Inclinometers

#### Reliable Measurement under Harsh Conditions

High Protection Class: IP69K

Fieldbus and Analog Interfaces

Safety, Redundant and ATEX  
Ex-Proof Versions Available

Successfully Integrated in  
Concrete Pumps, Drilling Machines,  
Working Platforms, Cranes, Wheel Loaders,  
Leader Masts and More

Visit us in Munich!



Hall A3, Booth 332

[www.posital.com](http://www.posital.com)

market, governmental safety standards demand to implement safety systems, such as back-up cameras in the USA and Automated Electronic Braking (AEB) systems from Euro NCAP. Vehicle-based camera systems have become a key differentiator for OEM (original equipment manufacturer) production using ADAS (advanced driver assistance system) technologies. As a primary processing platform in ADAS, Xilinx's customized ICs enable:

- ◆ Real-time analytics including object detection, recognition, classification, and tracking enable applications such as lane departure warning and pedestrian detection;
- ◆ Video processing and displays providing video frame capture, de-warp and stitching, along with 2D/2.5D/3D graphics and overlays allowing users to customize the look and feel of what is displayed to the vehicle driver and passengers;
- ◆ Programmable I/O blocks and solutions for various communication technologies such as CAN (FD) and Ethernet AVB featuring flexible and effective methods for distribution of video and control data;
- ◆ Fast time-to-market with differentiated products avoiding "me too" ASSP solutions while supporting rapidly changing ADAS requirements through the use of the company's programmable Smartcore IPs and comprehensive tools.

Xilinx automotive solutions also address the challenges of quickly adopting and migrating to the latest standards, interfaces, and IPs to handle real-time image processing from multiple cameras on a single device. Partial reconfiguration can dynamically swap-out components IP-based on system/vehicle state to minimize digital logic silicon footprint allowing the smallest possible component while providing custom processing functionality for a variety of ADAS feature bundles. With the high-levels of integration possible using Xilinx solutions, users can reduce the size, power consumption, and total cost of ADAS while meeting market windows ahead of the competition, claims the company.

## More competitors appear on the market

[Microsemi](#) launched automotive-graded FPGAs for the first time. The Igloo family is AEC-Q100 qualified and is specified for temperatures up to +125 °C. These components are positioned as an alternative to ASICs, providing a low-power, cost-effective, and secure solution for automotive applications including ADAS applications, vehicle-to-vehicle/vehicle-to-everything (V2V/V2X) communication, and electric/hybrid engine control units. "In addition to providing the highest operating temperature, our FPGAs also provide the lowest total power in their class, enabling automotive designers to maximize their dynamic power budget in compact and high performance systems to deliver highly differentiated automotive solutions at the lowest total cost of ownership," said Bruce Weyer from Microsemi. The products offer single event upset (SEU) immunity from neutron-induced firmware errors, helping them achieve the zero-defect rate essential for the automotive industry, as well as advanced security features and secure supply chain, stated the US-company.

Demand for high reliability in critical applications, ensuring zero-defect and tamper-free applications, continues to grow rapidly in the automotive industry. With an increase in security mandates amongst its customer base, Microsemi is the only vendor offering automotive-grade FPGAs at higher junction temperature, along with best-in-class security in low power and small footprint packages, claimed the company.

"The automotive market for semiconductors is forecast to grow to 32,3 billion US-\$ in 2016, from 30,3 billion US-\$ in 2015, an increase of almost seven percent," commented Colin Barnden, principal analyst at Semicast Research. "In comparison, we see the market for semiconductors in vehicle connectivity and ADAS growing at more than 20 % in 2016. Microsemi's Smart Fusion 2 and Igloo 2 products bring world class security features to the automotive industry and will address several challenges such as hacking, malicious tampering, and data theft faced by system designers in creating safe and secure systems for the connected automobiles of the future." The Igloo 2 FPGAs will be available in March 2016 for mass production, the company said.

Customized ICs with CAN core are not just interesting for the automotive industry. Also in other CAN markets such as industrial machine control, medical devices, etc. FPGAs become more attractive. [Kvaser](#) (Sweden) and [Peak](#) (Germany) were early birds providing CAN FD cores on FPGAs. And there are more under development. [Esd](#) (Germany) and [MEN](#) (Germany) use in their board-level products their own FPGAs with Classical CAN cores. When they migrate to CAN FD, they may update their FPGAs.

And don't forget the M\_CAN IP and the M\_TTCAN cores from [Bosch](#), which are licensed by many micro-controller manufacturers. They can also be integrated into customized ICs. Bosch has implemented them already in an FPGA used for example on the evaluation board designed jointly by Bosch, Daimler, and NXP. ◀



### Author

Holger Zeltwanger  
CAN in Automation  
[headquarters@can-cia.org](mailto:headquarters@can-cia.org)  
[www.can-cia.org](http://www.can-cia.org)



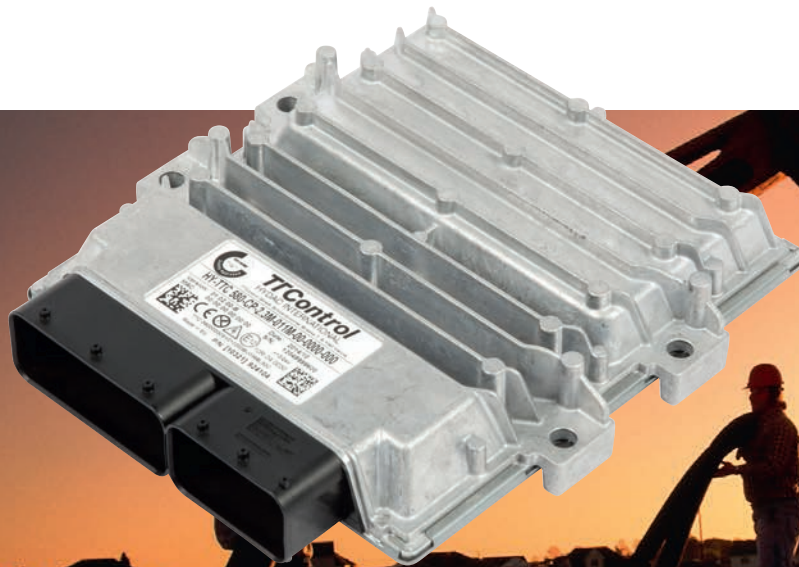

## Powerful Control Units for High-Safety Applications: HY-TTC 500 Family

### Flexibility & Usability

- Single controller for whole vehicle for centralized architectures
- Extensive I/O set with multiple software configuration options per pin
- Open programming environments C, CODESYS® V3.x and CODESYS® V3.x Safety SIL 2

### Safety

- TÜV-certified according to IEC 61508 (SIL 2) and EN ISO 13849 (PL d)
- ISO 25119 AgPL d certifiable
- CODESYS® Safety SIL 2 including support for CANopen® Safety Master and easy separation of safe / non-safe code
- Safety mechanisms in hardware to minimize CPU load
- Up to 3 output groups for selective shut-off in case of safety relevant fault
- Safety companion and safety mechanism in hardware

### Connectivity

- Up to 7 CAN interfaces
- Automatic baudrate detection and configurable termination for CAN
- Ethernet for fast download and debugging purpose

### Performance

- 32 bit / 180 MHz TI TMS570 dual core lockstep processor (ARM architecture)
- Up to 2.3 MB RAM / 11 MB Flash
- Floating-point-unit

### Robustness

- Automotive style housing suited for very rough operating conditions
- Total current up to 60 A

[www.ttcontrol.com/HY-TTC-500-Family](http://www.ttcontrol.com/HY-TTC-500-Family)



Safety Certified ECUs



General Purpose ECUs



I/O Modules



Safe I/O Modules



Operator Interfaces

# 20 years of CiA 401

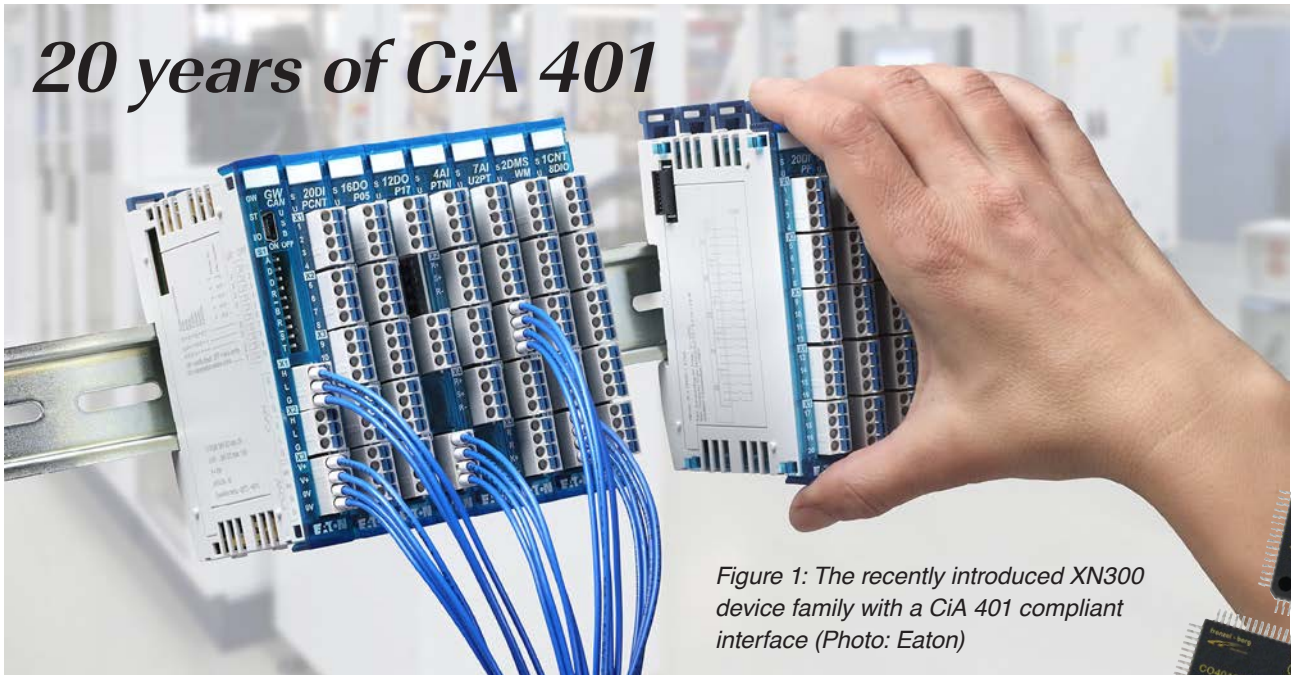

Figure 1: The recently introduced XN300 device family with a CiA 401 compliant interface (Photo: Eaton)

*CiA 401, the CANopen device profile for generic I/O modules was released in 1996. Nowadays version 3.1.0 is effective. The next version will include the mapping for 64-byte PDOs.*

The predecessor CiA 401 profile specification was developed by the Esprit project developing the CAL-based communication profile. After handing over to CiA (CAN in Automation) for further development and maintenance, the profile for modular I/O devices was released CiA-internally as version 1.3 in 1996 and implemented by several companies, e.g. Selectron and Weidmüller. The editor was Martin Jaeggi from Selectron. In those times, CiA members edited the specifications. Today, CiA engineers do it.

The CiA profile supported from the beginning different digital I/O granularities. Besides the mandatory 8-bit digital process data, 16-bit or 32-bit access was specified as well as a bit-wise access. The latter was not very often implemented. For analog I/Os the profile provides 16-bit resolution (mandatory) as well as 32-bit, floating point, and manufacturer-specific data types.

The version 1.4 pre-defined just two PDOs (process data objects). The next version (2.0) used already pre-defined PDOs. The first PDO transmitted digital inputs respectively received digital outputs. The other three PDOs contained each four analog I/O values. In case of other I/O port capability, the devices need to be configured. In order to avoid this, CiA 401 version 3.0 introduced the “M”-bit in the device type object (index 1000h). It indicates that a manufacturer-specific PDO mapping is implemented.

Since version 3.1 the profile has been split into two parts. Part 1 specifies generic I/O modules, while part 2 describes several joystick implementations with dedicated PDO mappings and some specific parameters. There is also the CiA 852 recommended practice for CiA 401-based operator environment sub-systems developed for

construction and mining machines. An important contributor for CiA 401-2 and CiA 852 was Dr. Heikki Saha, in those days working with Sandvik in Finland.

The recommendation has not been implemented very often. On the contrary, the CiA 401 generic profile is one of the most used I/O specifications: perhaps, it is the most implemented one. In CiA’s CANopen Product Guide several companies advertise their CiA 401 compliant devices.

Modular CANopen I/O devices from Beckhoff, B&R, Eaton (Moeller), Festo, Schneider Electric, Wago, and others have been on the market for many years. And there are more CiA 401 implementations. Some of them are very specific, e.g. I/O devices in IP65-rated enclosures from Turck and others. Many of the CANopen suppliers for construction machines and off-road vehicles provide I/O modules compliant to CiA 401. CiA 401 hero Selectron has changed its business focus from automation broad-liner to specialist for rail vehicle supplier over the last 20 years.

There are also micro-controllers with pre-programmed CiA 401 compliant software available, for example by Frenzel and Berg.



Figure 2: The Smartio CiA 401 compliant device dedicated for rail-vehicle applications by Selectron comes still in a purple colored housing as in 1996 (Photo: Selectron)



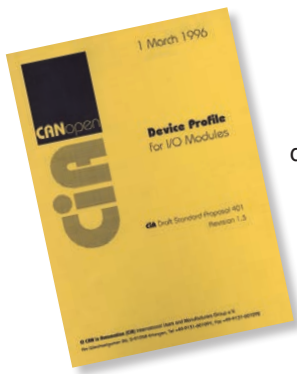

These I/O chips simplify the device design of CANopen I/O modules. Besides I/O devices available for many years, there are new CiA 401 implementations. At the SPS IPC Drives 2015 exhibition, Eaton launched the XN300 family and Weidmüller introduced CANopen support for its u-remote series (take a look at the insert "CAN Newsletter Online").

Although CiA 401 is twenty years old, there are some new enhancements under development. Especially, the PDO mapping is going to be updated due to the longer data frames (up to 64 byte) provided by the CAN FD data link layer. There is also the demand to improve the interoperability between host controllers and CiA 401 modules. This could be achieved by means of device classes using dedicated mappings as specified in CiA 852 for example.



**Author**

Holger Zeltwanger  
 CAN in Automation  
[headquarters@can-cia.org](mailto:headquarters@can-cia.org)  
[www.can-cia.org](http://www.can-cia.org)

**CAN Newsletter Online**

The CAN Newsletter Online sister publication provides brief product-related information. For more details please visit [www.can-newsletter.org](http://www.can-newsletter.org).



Control system  
**Suitable for mobile machines**

The increasing complexity of mobile machinery results in growing demands of I/O controllers. In accordance with those market requirements B-Plus (Germany) developed the b-CAN-Cube-Mini.

[Read on](#)



CiA 401  
**Q&A with Beckhoff**

Ralf Vienken from Beckhoff (Germany) answered five questions on the CiA 401 profile, CANopen I/O modules, and more.

[Read on](#)

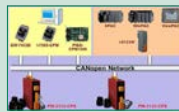

Three-phase power meter  
**With CANopen interface**

The PM-3133-CPS power meter by ICP DAS provides a CANopen interface for users to gather real-time power consumption information in connected devices. The meter complies with CiA 401.

[Read on](#)



Q&A with Frenzel + Berg  
**New versions of CANopen chips**

Erich Frenzel from Frenzel + Berg (Germany) answered questions about the CANopen I/O chip used in many different applications.

[Read on](#)

# CAN Products for your requirements



**CAN-Repeater  
 CRep DS 102**



**CAN-LWL-Router  
 CG FL**



**CAN-Repeater  
 CRep S8C**

- Repeaters for different network topologies
- Stub line connection of networks segments
- Optical fibre connection of copper networks
- Cascadable star wiring for up to 24 CAN channels with star repeaters



Sonnenhang 3  
 D-85304 Immünster  
 Tel.: +49-8441-49 02 60  
 Fax: +49-8441-8 18 60  
[www.ems-wuensche.com](http://www.ems-wuensche.com)

# The service robot Care-O-bot 4

*Service robots offer support in manufacturing and logistics as well as in everyday life situations. The open source Robot Operating System ROS and CANopen simplify the engineering and development process.*

The market for service robots – robot systems installed out of production environments – has been on the rise for quite some years. In 2014, the global sales of consumer products as well as of robots in professional application fields raised considerably, as presents the study World Robotics 2015, published by the International Federation of Robotics (IFR) and edited by Martin Hägele, head of the department robot and assistive systems at Fraunhofer IPA. Based on a survey of 300 companies worldwide, the forecasts for 2015 to 2018 estimate 25 million units sold for domestic robots and 150 000 units for professional service robots. The IFR-analysis reveals also that about 15 % of the companies are start-ups. The companies are highly technology-driven and were founded no longer than five years ago. This trend highlights the market potential that investors and entrepreneurs are seeing in the domain.

On the one hand, this remarkable development is due to technological advancements and cost reductions. Both “push” for newer application domains alongside manufacturing and industrial automation. Also, it helps service robots to become more accepted. On the other hand, new application scenarios in different fields “pull” for flexible robot systems that are easy to build, program, and (re-)configure. In order to supply this rising demand, developers and engineers are already and will be even more in need of appropriate system components and their drivers. The open source software framework Robot Operating System (ROS) offers many of them.

ROS gained much popularity in service robotics. It became the de-facto communication standard for mobile manipulation platforms and features a wide range of hardware drivers and higher level functionalities for navigation, manipulation, and perception. These building blocks enable manufacturers to reduce time and complexity for developing new robot systems. Instead of developing everything from scratch, system integrators benefit from a variety of compatible programs and services that follow consistent standards and can be issued independently from a specific hardware. The service robot Care-O-bot is a good example to explain how complex robot systems can profit from ROS.

## The development of Care-O-bot

Assistive robots represent one of the upcoming markets. They could help elderly or handicapped people and undertake several tasks in the service sector. At Fraunhofer IPA, the scientists already started in the early '90s to work



*Figure 1: The construction of Care-O-bot 4 allows individual robot platforms to be established for a range of applications (Source: Fraunhofer IPA/Photo: Rainer Bez)*

on service robotics technologies. The name Care-O-bot should reflect the capacities to help in a variety of everyday life situations. The first generation was introduced in 1998. At the beginning of 2015, Care-O-bot 4, which has been developed in cooperation with the company Schunk, was presented (Figure 1). While its predecessors were used primarily in the development of technological fundamentals, Care-O-bot 4 is a modular product family providing the basis for commercial service robot solutions. This system is setting new standards in technological aspects as well as in the design. ▶

A service robot shares its environment with humans. For this reason, a friendly and likeable appearance of the robot is important, because otherwise people would not easily accept it in their vicinity. That is why the scientists developed a unique design concept together with the design studio Phoenix Design located in Stuttgart. The result is a characteristic shape with slender forms and clear lines. Both designers and scientists had to cope with one of the most important challenges: Creating a friendly, gentleman-like robot, a new archetype for such devices and at the same time developing a form under which all technical components find their place and that allows a wide range of motion, e. g. bending down. This successful liaison of form and function of Care-O-bot 4 was awarded with the Red Dot Award: Product Design in 2015. It is part of only 1,6 % of the submitted products which received the label "best of the best".

One main criterion for the fourth generation of Care-O-bot was to build a modular system that can be configured according to the particular application scenario. The complete system has up to 31 axes, 28 degrees of freedom, weighs 140 kg, and measures 158 cm. Many modules communicate via CANopen or Gigabit Ethernet. To meet the safety requirements, the robot has three safety laser scanners and several emergency stops. Integrated in both grippers are RGB-D cameras with a range of 15 cm to 200 cm and a special LED light system (Figure 2). Whereas the configured robot with two arms and grippers, user interface on its head, and sensor ring

enables the maximum of tasks, it is also possible to use only the omnidirectional base as a serving trolley. If the intended purpose is to serve drinks, a tray replaces one hand. This targeted adaption for specific tasks reduces costs.

The various hardware modules are encapsulated and can be composed with the help of custom connectors that provide communication, power, and safety interfaces. With exception of the grippers, all actuators are connected with CAN internally. CAN was chosen because it is very robust and less susceptible to electromagnetic interferences. In particular, some signals had to be routed via slip rings right next to the motor currents. Depending on the configuration, the robot has up to 21 axes that are driven by CiA 402-compliant controllers distributed over up to five networks.

### ROS and CANopen software stack

As mentioned above, ROS is currently the most widely used software framework or middleware for robotics. It has been available since 2007 and was developed by researchers from Stanford University in order to create a standardized architecture for service robots. Even though ROS is open source, a commercial usage is possible and, in fact, has already been pursued by many organizations. Since ROS runs under the BSD license (Berkeley Software Distribution), everybody can change and use the code for commercial purposes as long as the original copyright is kept. ▶

# CAN Products for your requirements



**CTrans OL**



**EtherCAN CI-ARM9**

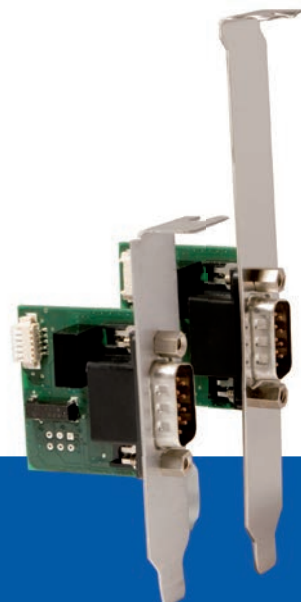

**CPC-USB/embedded**

- Economical solutions for series applications
- Optimized for industrial applications
- Solutions for stationary and mobile use
- Software support for bus-analysis, measurement and control



Sonnenhang 3  
D-85304 Immünster  
Tel.: +49-8441-49 02 60  
Fax: +49-8441-8 18 60  
[www.ems-wuensche.com](http://www.ems-wuensche.com)



Figure 2: With its arms and one-finger-hands the robot can handle even difficult objects (Source: Fraunhofer IPA/Photo: Rainer Bez)

Care-O-bot 4 demonstrates different use cases for ROS: About one third of the robot's components are already existing open components. The engineers have access to established solutions. Another third of the code was developed by experts at Fraunhofer IPA and then made freely available for the community. Fraunhofer IPA developed also the remaining code, which is marketed via licenses. This shows how ROS enables technical progress. Thanks to the community-driven development, every programmer can focus on its special expertise and improve the open source code for all users. At the same time, the usage as "closed source" is also possible, which encourages companies to adopt ROS. Thereby, they can benefit from standardized tools and vendor independency.

Part of the freely available ROS components that run on the service robot is the driver framework `ros_canopen`. The stack is running under Linux, with or without linkage to ROS. It has been implemented in C++ and is divided into several layers (Figure 3) in order to enhance its flexibility and extensibility. The connection to the CAN network is enabled by SocketCAN, which is included in the mainline kernel and supports an increasing number of interface devices. Regarding the CANopen master implementation, the driver is automatically configured based on the EDS files for the slave devices. It supports most services like Network Management (NMT), Service Data Objects (SDO), Process Data Objects (PDO), Synchronization Objects (SYNC), Emergency Objects (EMCY), or Heartbeats. On top of it, a ROS interface was implemented that provides further configuration and introspection functionalities.

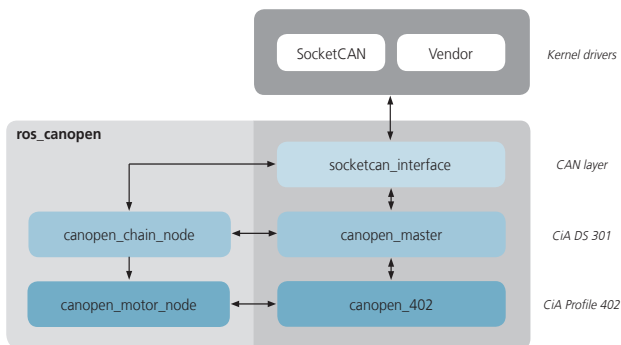

Figure 3: Software package structure of the `ros_canopen` stack (Source: Fraunhofer IPA)

## CAN Newsletter Online

The CAN Newsletter Online sister publication provides brief product-related information. For more details please visit [www.can-newsletter.org](http://www.can-newsletter.org).



### Expertdays: Mobile robots are the future

Schunk has organized the 6th Expertdays in its facilities in Lauffen (Germany). More than 100 service robot experts participated in this annual 2-days event, which took place end of February.

[Read on](#)



### For service robots and industrial handling

The LWA 4 Powerball Light-weight-arm sub-system by Schunk (Germany) has been designed for stationary and mobile applications in service robotics and industrial handling.

[Read on](#)



Safety grippers

### Humans and robots working together

Schunk, known for its safety grippers, has presented safety concepts for each of its mechatronic pillars. The goal: a method for collaboration between humans and handling systems.

[Read on](#)



5-finger gripper hand

### Almost human

The mechatronic SVH 5-finger gripper hand from Schunk, designed for service robot applications, is ready for serial production. The grippers are very similar to the human model.

[Read on](#)



Parallel gripper

### Reducing cycling times

The Schunk (Germany) EGL 70 mechatronic parallel gripper comes with variable gripping force between 50 N and 600 N. It was specifically developed for industrial applications.

[Read on](#)



### Two-finger parallel gripper with CAN

Schunk (Germany) has launched its WSG-32 gripper dedicated for handling small components. It provides optionally a CAN interface.

[Read on](#)

Other protocol layers can be integrated via a protocol stack concept. As a reference implementation, the CANopen 402 device profile for drives and motion control is available. Its basic features like command forwarding and drive mode switching are accompanied by enhanced ROS functionalities in a separate software package. It virtually represents a group of drives as a kinematic chain and provides synchronous access to its components. Furthermore, it is fully integrated with another software framework, `ros_control`, which abstracts the controller interface from the actual hardware implementation. The ROS community provides different software packages for multi DOF-trajectory execution and differential wheel control that can be used out of the box. ▷

## Related articles

- ◆ [Annegret Emerich \(CiA\): Rise of the service robots](#)
- ◆ [Cindy Weissmueller \(CiA\): Mechanical assistants with embedded CAN networks](#)
- ◆ [Holger Zeltwanger \(CiA\): Service robots need smart grippers](#)
- ◆ [Holger Zeltwanger \(CiA\): Service robots: CAN in embedded networking](#)

## ROS-Industrial initiative

The `ros_canopen` driver is being promoted by the ROS-Industrial initiative, and especially within the two ROS-I Consortia in North America and Europe. The ROS-I initiative aims at easing the adoption of ROS for industrial settings and applications. Although the licensing is suitable for industrial usage, and ROS itself has been extensively used in practice (especially in the fields of research and service robotics), other aspects are also important for companies intending to adopt ROS within their technology stacks. These include e.g. matters of liability, hardware support and quality assurance.

In order to fill this gap and to provide financial and managerial support to the initiative, the ROS-I consortium North America was founded in 2013. Under the head of Dr. Ulrich Reiser, group leader at Fraunhofer IPA, a European consortium was launched one year later in 2014.

The consortia act as mediators between the open source community and more traditional industrial institutions. The number of members is rising very quickly: as of January 2016, 38 organizations, including research institutions and commercial companies, are part of the two consortia. With the financial resources provided also through their membership fees, joint technical projects (Featured Technical Projects or FTPs) of special interest and directed towards industrial applications can be financed, as well as the general management of the industry-specific parts of the ROS codebase. Fraunhofer IPA is not only managing the European consortium, but it contributes as well to both the development of new components, like the `ros_canopen` driver, and to the maintenance of existing ROS software. Furthermore, it is an independent technology partner suitable for all projects concerning the planning, conception, and developing of service robot technologies. ◀



### Author

Mathias Lüdtkke  
Fraunhofer IPA  
[mathias.luedtke@ipa.fraunhofer.de](mailto:mathias.luedtke@ipa.fraunhofer.de)  
[www.ipa.fraunhofer.de](http://www.ipa.fraunhofer.de)

**OPUS**<sup>®</sup>  
Technology for Man & Machine



**bauma 2016**

Munich  
April 11-17, 2016  
Hall B5, booth 427

**WACHENDORFF** Elektronik  
TOPCON POSITIONING GROUP

[www.wachendorff-elektronik.de](http://www.wachendorff-elektronik.de)

# Safety-integrated hardware solutions

*In automotive and industrial applications, interactions between the human body and electrical/electronic systems are increasing significantly. Specifically when managing safety-critical decisions this can have a severe impact on a people's health.*

As the evolution of advanced safety systems moves from passive to more active, including predictive safety and even autonomous vehicle concepts, the industry has and will continue to demand that strict requirements be met.

Managing these safety-critical decisions is trending toward increased complexity and additional software content in safety systems. With greater complexity, there are increasing risks of systematic and/or random hardware failures. To help ensure the highest safety standards and influence the development of safe automotive systems, the industry has released the latest automotive safety standard: ISO 26262. Assessing the functional safety of a system requires a significant level of engagement and verification. Simplifying this assessment is one of the main objectives of the NXP Safe Assure program which applies to both automotive and industrial applications.

Safe Assure products are designed to reduce the complexity of functional safety systems—a key objective of the manufacturers of these systems. The program was developed with a strong emphasis on failure modes and effects analysis (FMEA), continuous process improvement (CPI) and zero defects. The new product development (NPD) flow, tools, and metrics have also been modified to incorporate and manage functional safety requirements. Specifically, the product definition phase now includes system-level assumptions as part of describing the system-level context. For semiconductor devices, these assumptions are made as a Safety Element out of Context

(SEooC). Since MCUs and analog companion chips are developed as standard solutions to address multiple applications in multiple industries, the SEooC is a safety-related element that is not developed for a specific system or a particular vehicle platform.

Electric power steering (EPS) is one of many automotive applications that requires a high level of safety to ensure a vehicle's steering system is predictive and deterministic. Depending on the combination of hardware and software interaction used to meet ASIL-D requirements in a particular application, several approaches or system architectures are possible. The first approach is to use two MCUs to conduct an external comparison of safety outputs. The advantage of this architecture is the physical duplication of safety- and non-safety-related functions and features. However, the high complexity of this configuration combined with software synchronization and increased PCB space create a major challenge and barrier for this approach. Because of the increased number of devices, the reliability and the availability of system functions are reduced. This configuration may introduce a transient fault such as a single event upset and does not facilitate having a good tolerance in this regard.

An alternative approach, developed by NXP, uses the latest generation of multicore MCUs operating in lock-step mode. The design includes an internal self-test combined with advanced analog power management solutions that monitors the MCU and controls the fail-safe system state. The increased integration of the second approach reduces

the size of the board and the complexity of the system. Using the lock-step mode and integrating the monitoring into the power supply device improves availability and allows a high level of safety. In addition, software development is less complex than in the first approach.

The NXP hardware system concept for the next generation of functional safety comprises the MPC5744P and the MC33907, the latest generation of system basis chip (SBC) designed to meet the ISO 26262 standard safety requirements. MC33907 and MC33908 system basis chips have received

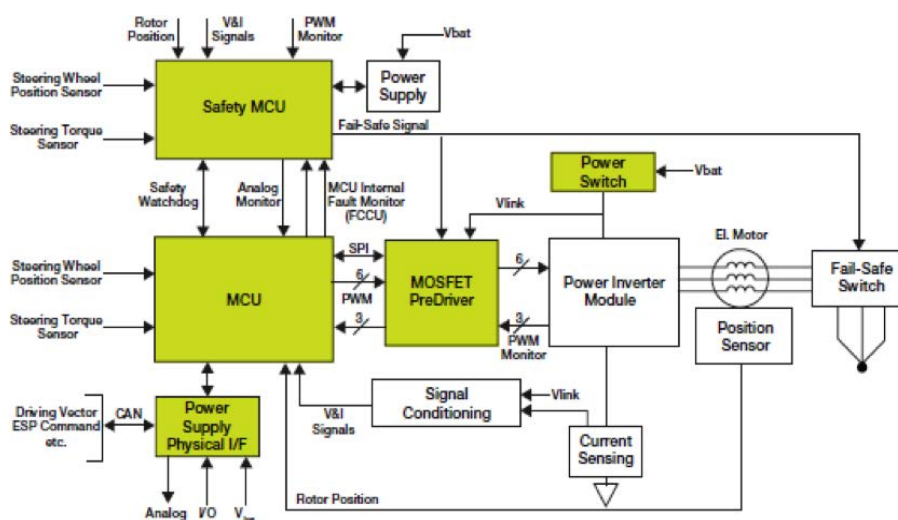

Figure 1: EPS Based on a Single Core and a Safety MCU (Photo: NXP)



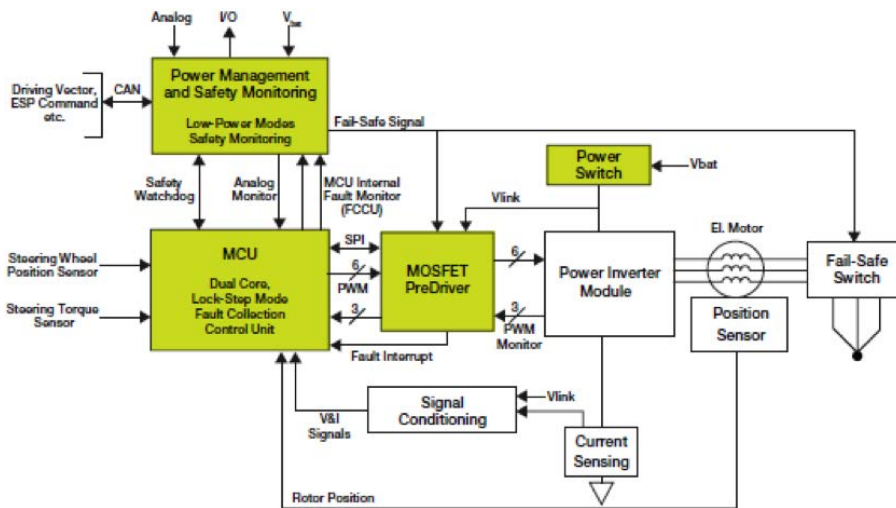

Figure 2: NXP-integrated Safety Architecture for an ASIL-D EPS System (Photo: NXP)

ISO 26262 functional safety assessments up to the ASIL-D level from one of the world's foremost automotive safety assessment organizations. The assessment was conducted by TÜV SÜD, an independent and renowned functional safety accredited appraiser, which assessed the NXP products up to the most stringent automotive safety integrity classification.

The MC33907 combines an energy management unit (EMU) based on an efficient DC/DC power supply that can be switched into a low-power mode. The main functions of the MC33907 are to supply and monitor the MPC5744P MCU. Its power management is associated with various safety mechanisms, developed in combination with the MC5744P, to avoid a malfunction in an application that results in a dreaded event. Using both devices in a system can reduce the effort needed to achieve an ASIL-D system-level solution. Communication with other parts of the system (car, truck, industrial machines) is managed through the available CAN and LIN transceivers integrated in the MC33907.

The MPC5744P is a dual-core lock-step MCU with integrated safety architecture. Built-in self-test (BIST) mechanisms are provided for the cores, memories, crossbars, communication blocks, and peripherals. In addition, the device is optimized to prevent common cause failures induced by clock or voltage-supply issues. The MPC574xP family provides hardware blocks for detection of clock deviations as well as hardware monitors for main voltages such as internal core voltage and flash supply voltage. The dual-core MPC5744P replicates other key hardware blocks in addition to the cores. These include the crossbar, memory protection units, interrupt controller, DAM, and a software watchdog timer. The main benefit of this sphere of replication is the capability of the MCU to detect single-point failures that tend to occur more frequently as soft errors, not only in the cores but also in key sub-modules.

Inside the MC33907, the power-management unit and the fail-safe machine combine to interact with the MCU. Four safety measures are implemented to secure the interaction between the MCU and SBC uninterrupted supply, fail-safe inputs to monitor critical signals, fail-safe outputs to drive a fail-safe state, and watchdog for advanced clock monitoring. When combined with the MPC5744P MCU, each safety

measure is optimized for the highest level of safety performance. During the development of the components, a complete failure modes, effects, and diagnostics analysis (FMEDA) was developed to measure the safety performances in terms of single point of failure, latent failure, and common cause failures (CCF). This type of safety analysis is part of the support deliverables for the Safe Assure products and is the result of a mixed-device failure mode analysis to determine system safety. Device architectures have been implemented with the specific goal of reducing FMEDA risks.

As an example, the reduction of CCF is addressed by segregating the main function (supply and communication) and the fail-safe machine (a group of independent safety features, such as monitoring, detection, and safe-state control). This specific measure has been implemented to reduce the CCF and, combined with analog and digital BIST, contributes to reduce latent failures.

At the system level, safety-check mechanisms proposed by the MPC5744P can be monitored by the MC33907 through the bi-stable protocol of the fault collection control unit (FCCU). This IC cross-checking, like the challenger for monitoring timing, provides external measurement of the system and offers a redundancy to further secure fault detection. In line with safety architecture of the system basis chip family, a redundant path for safety-state activation occurs through dedicated fail-safe outputs. These outputs complement the MCU fail-safe outputs by setting the application into a deterministic state when a failure condition occurs. These hardware implementations help software engineers simplify the software architecture and implement a software-development strategy that focuses on safety using a single MCU approach. Finally, detailed documentation is provided that describes functional safety, the safety goals, and the safety implementation of each component, thus enabling the use of standard semiconductor devices for the management of various safety applications. ◀

Author



David Lopez  
Yves Legrand  
NXP Semiconductors  
[www.nxp.com](http://www.nxp.com)

Good to know:  
Optional is not  
"don't care"

*In CANopen, there are specified mandatory, conditional, and optional parameters. If you don't implement optional ones, your device still has to behave as specified.*

It is obvious: Mandatory parameters specified in the CiA 301 application layer have to be implemented. Some parameters are conditional. For example, if you implement PDO communication parameters you also have to provide the corresponding PDO mapping parameters. Optional parameters may be supported. Of course, if a CANopen device provides the optional function, it must follow the specification.

But what happens, if you don't implement an optional parameter. If the default value attribute is "none" or "manufacturer-specific", your device behaves, as you want. If this attribute has a specified value, your product needs to follow this specification. An example: The error behavior parameter (index 1029h) is an array-type object specifying the local NMT finite state automaton (FSA) transitions in case of severe errors. It is optional. Sub-index 1 (communication error) specifies a default value of "00h" (data type: Unsigned8) meaning that the device must transit into NMT pre-operational state, if it is in NMT operation state when the severe error occurs. Severe errors include Heartbeat events or bus-off conditions of the CAN controller. If this object is not implemented, the device must behave as specified: It shall transit into the specified NMT state. Only when implemented, the system designer can configure another behavior (for example to keep the NMT state or to transit into NMT stopped state).

### Optional parameters in profiles

Optional parameters in CANopen device, application, and interface profiles follow the same interpretation as described above. In CiA 401 (CANopen device profile for generic I/O modules), the "polarity digital input 8-bit" parameter (index 6002h) is optional. The default value is specified as

"00h" meaning inputs are not inverted. This means, it is not allowed to provide an input inversion function, if this object is not implemented. In case of CiA 401, this is also clearly described in the profile specification: "If an optional parameter is not implemented, the device shall behave as specified in the default value attribute."

Other profile specifications don't mention this explicitly. Nevertheless, optional parameters with dedicated default values determine the device's behavior. For example, CiA 402 (CANopen device profile for drives and motion control) specifies for the "quick stop option code" parameter (index 605Ah) a default value of "+2" meaning "slow down on quick stop ramp and transit into switch-on-disabled". This behavior is mandatory, even if the parameter is not implemented. It is not allowed to behave differently.

To summarize, CANopen devices must behave as specified in the default value after power-on. This is also valid for optional parameters. Optional does not mean your device may behave any way. It is also not allowed implementing a congruent functionality using manufacturer-specific parameters. This would decrease interoperability of CANopen devices, an important feature of CANopen device profile specifications. ◀

#### Author

Holger Zeltwanger  
CAN in Automation  
[headquarters@can-cia.org](mailto:headquarters@can-cia.org)  
[www.can-cia.org](http://www.can-cia.org)





# Hardware & Software for CAN & CAN FD Applications

## ■ PCAN-Explorer 5

Universal CAN bus monitoring software

The PCAN-Explorer 5 is a comprehensive Windows software for monitoring and analyzing CAN data traffic.

- Simultaneous connections to multiple networks (connected via the same hardware type)
- Clear display of the CAN traffic with various information
- Configurable symbolic message representation
- Data logging with tracers and the 4-channel Line Writer
- Multiple flexible filters
- Easy message transmission
- VBScript interface for the creation of macros
- Supports Windows 10, 8.1, 7, Vista (32/64-Bit)
- Functionality upgrades with add-ins:
  - **Plotter Add-in:** Recording and graphical representation of multiple signal sequences
  - **Instruments Panel Add-in:** Representation of digital and analog signals via graphical instruments for easy simulation of complex CAN applications
  - **J1939 Add-in:** Support for all functions of the SAE J1939 network protocol
  - **CANdb Import Add-in:** Import of CANdb files

■ **Now:** Basic training for groups or individuals. If you are interested, please contact [training@peak-system.com](mailto:training@peak-system.com).

## ■ PCAN-Rover FD

Programmable Converter for CAN FD and CAN

The new PCAN-Rover FD has two CAN channels that support the CAN FD standard in addition to the conventional CAN 2.0 specification. The module behavior and the data exchange between the two channels are freely programmable. Thus, for example, a conversion of CAN to CAN FD and vice versa is possible and new CAN FD applications can be integrated into existing CAN 2.0 networks.

- ARM Cortex M4F microcontroller
- 4 kByte On-chip EEPROM and 4 MByte SPI flash
- Two High-speed CAN channels (ISO 11898-2)
  - Comply with CAN specifications 2.0 A/B and FD
  - CAN FD support for ISO and Non-ISO standard
  - CAN FD bit rates for the data field up to **12 Mbit/s**
  - CAN bit rates from 25 kbit/s up to 1 Mbit/s
- 1 I/O-connection: digital input and output
- RS232 serial data transfer, alternatively 2 digital inputs
- Available in aluminum casing with two 9-pin D-Sub connectors or one 10-pole screw-terminal strip (Phoenix)
- Extended operating temperature range from -40 to 85 °C
- Scope of supply includes a development package for C and C++ with a library and programming examples
- Custom firmware can be uploaded via CAN using a PC CAN interface from PEAK-System



*CAN in Automation*

The non-profit CiA organization promotes CAN and CAN FD, develops CAN FD recommendations and CANopen specifications, and supports other CAN-based higher-layer protocols.

# *Join the community*

to proof interoperability of your ISO CAN FD implementations and products.

Members may attend:

## **CAN FD plug fests**

April 6 and 7, 2016

Detroit (USA)

June 2 and 3, 2016

Nuremberg (Germany)

*For more details, please, contact CiA office  
at [secretary@can-cia.org](mailto:secretary@can-cia.org)*

*[www.can-cia.org](http://www.can-cia.org)*