

June 2018

# CAN Newsletter

Hardware + Software + Tools + Engineering



*Retrofitting port cranes set to boom*  
*CAN in aquaplaning warning system*  
*Online diameter control during wire*  
*and cable production*

Applications

[www.can-newsletter.org](http://www.can-newsletter.org)

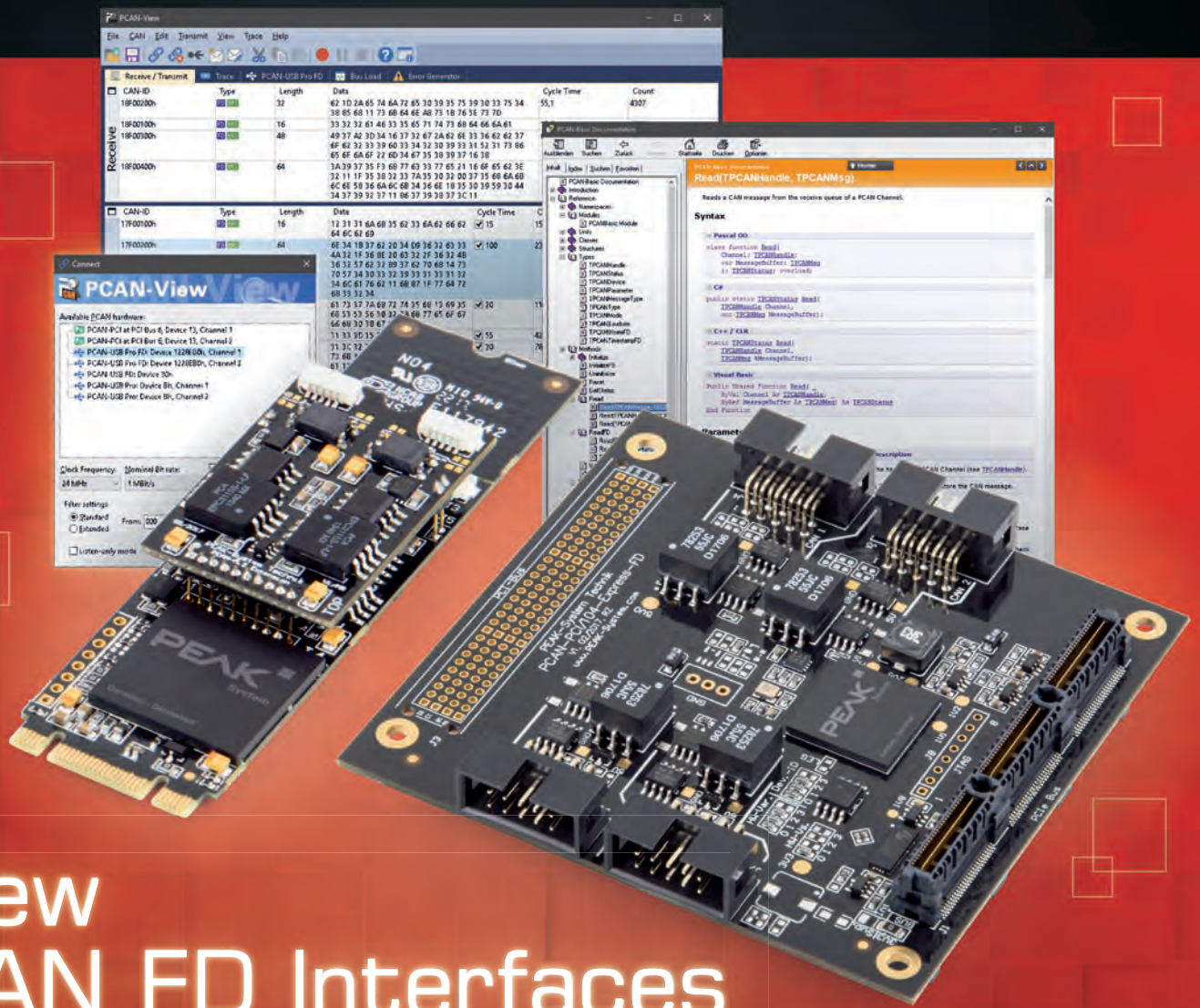

# New CAN FD Interfaces

## ■ PCAN-M.2

CAN FD Interface for M.2 (PCIe)

- CAN interface for the M.2 slot (uses PCIe lane)
- 1, 2, or 4 High-speed CAN channels (ISO 11898-2)
- Form factor M.2 type: 2280/2260-B-M; Height: Single and Dual Channel 4.6 mm; Four Channel 10.2 mm
- Complies with CAN specifications 2.0 A/B and FD
- CAN FD support for ISO and Non-ISO standards switchable
- CAN FD bit rates for the data field (64 bytes max.) from 20 kbit/s up to 12 Mbit/s
- CAN bit rates from 20 kbit/s up to 1 Mbit/s
- CAN bus connection via connection cable and D-Sub, 9-pin (in accordance with CiA® 303-1)
- MCP2558FD CAN transceiver
- Galvanic isolation on the CAN connection up to 300 V, separate for each CAN channel
- CAN termination can be activated through a solder jumper, separately for each CAN channel
- PCIe data transfer via bus master DMA
- DMA memory access operations with 32- and 64-bit addresses
- Measurement of bus load including error frames and overload frames on the physical bus
- Induced error generation for incoming and outgoing CAN messages
- Extended operating temperature range from -40 to 85 °C (-40 to 185 °F)

## ■ PCAN-PCI/104-Express FD

CAN FD Interface for PCI/104-Express

- PCI/104-Express card, 1 lane (x1)
- Form factor PC/104
- Up to four cards can be used in one system
- 1, 2, or 4 High-speed CAN channels (ISO 11898-2)
- Complies with CAN specifications 2.0 A/B and FD
- CAN FD support for ISO and Non-ISO standards switchable
- CAN FD bit rates for the data field (64 bytes max.) from 20 kbit/s up to 12 Mbit/s
- CAN bit rates from 20 kbit/s up to 1 Mbit/s
- Connection to CAN bus through D-Sub slot bracket, 9-pin (in accordance with CiA® 303-1)
- MCP2558FD CAN transceiver
- Galvanic isolation on the CAN connection up to 500 V, separate for each CAN channel
- CAN termination and 5-Volt supply can be activated through solder jumpers, separately for each CAN channel
- PCIe data transfer via bus master DMA
- DMA memory access operations with 32- and 64-bit addresses
- Measurement of bus load including error frames and overload frames on the physical bus
- Induced error generation for incoming and outgoing CAN messages
- Extended operating temperature range from -40 to 85 °C (-40 to 185 °F)



[www.peak-system.com](http://www.peak-system.com)

Take a look at our website for the international sales partners. Scan the QR code on the left to open that page.

PEAK-System Technik GmbH

Otto-Roehm-Str. 69, 64293 Darmstadt, Germany  
Phone: +49 6151 8173-20 - Fax: +49 6151 8173-29  
E-mail: [info@peak-system.com](mailto:info@peak-system.com)

**PEAK**  
System



## Applications

Retrofitting port cranes set to boom	4
CAN in aquaplaning warning system	22
Online diameter control during wire and cable production	36

## Imprint

### Publisher

CAN in Automation GmbH  
Kontumazgarten 3  
DE-90429 Nuremberg

[publications@can-cia.org](mailto:publications@can-cia.org)  
[www.can-cia.org](http://www.can-cia.org)

Tel.: +49-911-928819-0  
Fax: +49-911-928819-79

### CEO

Reiner Zitzmann

AG Nürnberg 24338

### Downloads March issue:

(retrieved May 25, 2018)  
3067 full magazine

### Editors

[pr@can-cia.org](mailto:pr@can-cia.org)

Cindy Weissmueller (cw)  
Holger Zeltwanger (hz)  
(responsible according  
to the press law)

### Layout

Nickel Plankermann

### Media consultants

Gisela Scheib  
(responsible according  
to the press law)  
Gertraud Weber

### Distribution manager

Holger Zeltwanger

### © Copyright

CAN in Automation GmbH



## Devices

Modules for industrial service robotics	10
Accurate leveling even during acceleration, braking, and cornering	20
The CANopen logical device approach suites mobile robots and AGVs	24
Tiny PLC integrated into strut profiles	34
Self-configuring CANopen controller	40



## System design

Migration to CANopen FD or no advantage without disadvantage	26
Security expectations vs. limitations	30



## Testing

Networking with CAN FD - What about testing?	12
Functional GUI testing of IVI systems	16

## General Data Protection Regulation

On May 25, 2018 the General Data Protection Regulation (GDPR) is in power. It protects European citizens' privacy and prohibits companies to contact individuals without given permission.

CAN in Automation (CiA) respects this EU regulation. This means, CiA will send commercial emails offering its services only to those individuals, who have provided permission by email or have registered (double opt-in) on our websites. Normally, we need just the email address for our email services such as the monthly CiA Members News and the monthly [CAN Info Mail](#). The same is with [CiA's Weekly Telegraph](#) providing headlines and brief information about published articles in the [CAN Newsletter magazine](#), which you are reading right now and its sister publication, the [CAN Newsletter Online](#).

To summarize, CiA needs your permission to send emails to you. This means, you should take the initiative requesting information from us – especially, if you like to receive our above-mentioned email services.

Cindy Weissmueller

# Retrofitting port cranes set to boom

*Terminal operators' low-appetite for port cranes in 2017, does not mean that there is no business for spreader manufacturers. Retrofitting is on the agenda, especially for spreaders with container weighing functionality.*



Figure 1: The life span of spreaders is about 10 to 12 years, the first CiA 444 generation products introduced between 2006 and 2008 are actually coming of age (Photo: Kalmar)

Growing global container traffic is one of the major factors driving the global shipping container market. The global container traffic is growing progressively after a steep decline in 2009. The steep decline in container traffic growth is mainly because of the after-effects of the global recession in 2008. The global shipping container market is one of the few markets that showed a quick recovery after the recession. Technavio has published a market research report. It reports an annual growth of around nine percent for the global shipping container market in the period from 2018 to 2022.

Another trend is the retrofitting of port cranes. Bromma, one of the market-leading spreader suppliers,

provides additional functionality to improve the spreader performance. Retrofit products include CANopen serial crane communication, HIS (Height Indication System), INRS (Impact Noise Reduction System), LED indicator lamps, SCS (Spreader Control System), TTDS (Twin-Twenty Detection System), and load sensing. The mentioned CANopen interface to the crane complies with the CiA 444 profile series. Bromma's spreader are using also embedded CANopen networks. They enable for example the automation of twistlock handling when a container is loaded or unloaded from a vessel. This was the missing link in a fully automated container terminal. Bromma has introduced its ALP twistlock handling system in 2015. ▶

## Container weighing by the spreader

In order to balance the load of a vessel, it is necessary to know the weight of the container. Spreaders able measuring the weight of the grabbed container avoids separate weighing equipment and saves time in the container handling. Since 2016, all export containers need to provide the Verified Gross Mass (VGM). The challenges for the actors in the supply chain to comply with the requirement are several. One of the biggest is how to establish the VGM. Where to weigh? What equipment to be used and what are the requirements on the equipment? The local authorities of each country define the formal requirements related to accuracy and to certification.

A review of the various technologies available for weighing in a terminal boils down to two main alternatives: weighbridges and spreader twistlock based load sensors. When reviewing these two technologies, there are a number of characteristics, which distinguish them. Different characteristics do not mean that one technology is better or more suitable than the other but the characteristics will influence the logistic flows and procedures in the terminal in different ways.

Weighing bridges are a long-time established technology, which is and typically has been used to measure the weight of vehicles. This is the technology that offers the highest "equipment accuracy". The weight of the container-loaded trucks is measured and when the empty vehicle is leaving it is measured again. Another option is to deduct the



Figure 2: CANopen load sensors are installed in the twistlocks of the spreader to measure the weight of the container when lifted (Photo: Tecsis)

kerb weight from the total weight to determine the container weight.

If the typical situation in a container terminal is that the trucks leave the terminal empty after delivering the container, weighing the empty vehicle on the way out might not be such a big additional step but in many terminals that is not the case. In fact, some countries have programs and directives established to encourage the trucks not to leave the terminal empty. It is therefore assumed that weighing the empty truck needs to impose an additional step in the logistic flow that many want to avoid. ▶



Making mobile machines perform  
Efficient | Safe | Green

## Multifunctional Power Pack!

### ESX-3CS

Freely programmable central control unit

- Supports development in IEC 61131-3, "C" and Matlab
- Flexibility through multifunction I/O's
- Extensive communication interfaces
- Part of a scalable family concept

Besuchen Sie uns auf diesen Messen



INTERFORST, München  
18.07. – 22.07.2018, Halle B6, Stand 308



SPS/IPC/DRIVES, Nürnberg  
27.11. – 29.11.2018, Halle 7, Stand 150

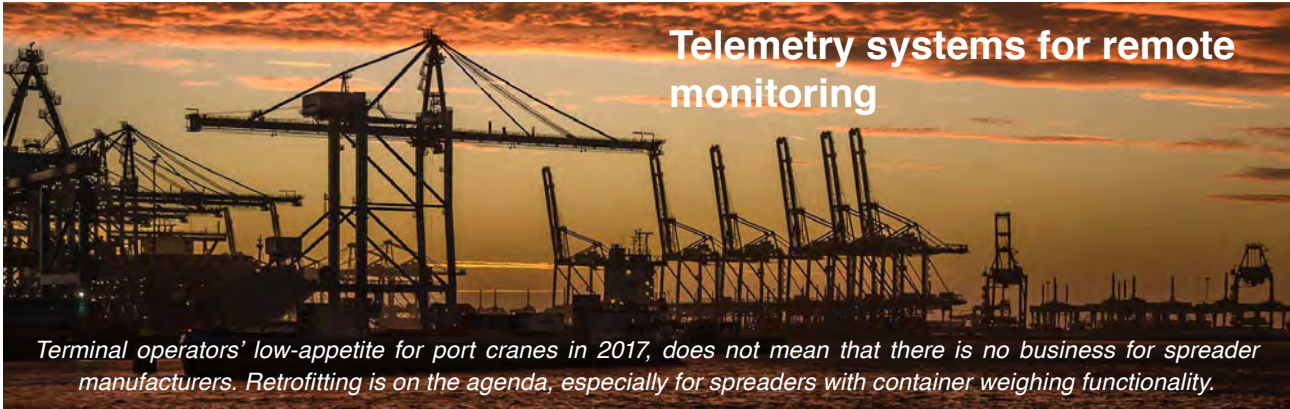

## Telemetry systems for remote monitoring

*Terminal operators' low-appetite for port cranes in 2017, does not mean that there is no business for spreader manufacturers. Retrofitting is on the agenda, especially for spreaders with container weighing functionality.*

"We are using the CAN interfaces in straddle carriers and other container handling equipment to collect data," said Carmelo Occhipinti from Datamatic. Via the Ethercan gateway by Kvaser this data is forwarded to the terminal operating systems (TOS) to analyze it. "The result is the optimization in the use of machineries and personnel, greatly reducing inefficiencies in operations, increasing profits and customer satisfaction," Occhipinti added. It is a challenge when connecting computing units to heavy machinery such as a crane, because of the physical conditions: vibration, dust, and dirt ingress are the most commonplace. Gustavo Gasparini from Kvaser's Italian distributor explained: "The Ethercan provides greater stability of connection than USB because Ethernet permits a small disconnection from time to time."

A port's success primarily depends upon efficient use of equipment and personnel. A focal point is the cranes, which are becoming increasingly state-of-the-art and consequently, valued in the millions of euros or dollars each. Just like any other expensive assets such as drill rigs, agricultural, or construction equipment, machine monitoring via CAN has the potential to enhance container terminal operating efficiency by minimizing downtime due to maintenance issues.

Datamatics Group's Neptuno TOS solution integrates data generated by the port's many machine sensors with container-related data, providing an overview of the entire terminal's activities. A crane system typically has five or more CAN-connected ECUs. The Ethercan Light HS CAN-to-Ethernet gateway is used to

connect the crane's CAN network to a rugged PC in the cabin. Combining CAN data with inputs from proprietary sensors, cameras, and positioning information, enables to create a comprehensive crane telemetry system that feeds information to the TOS.

Carmelo Occhipinti explained: "CAN allows us to collect data in real-time on the crane's operating parameters, such as fuel consumption, crane lift angle and extension, load weight, move duration, grasp engagement, etc. We use this information to produce a variety of dashboards and KPIs to analyze operating conditions and provide feedback to help the customer optimize the use of their cranes. For example, an alarm is transmitted to the maintenance director if the crane's tire pressure goes below a certain threshold, as tires at optimal pressure save at least 10 percent of the fuel used. This type of real-time monitoring applies to all the crane's main components, avoiding unplanned stops and reducing the risk of equipment damage."

All crane movements are transmitted in real-time to the TOS, including critical data such as the exact route taken by the crane to place the container in the stack (so that the cost of every movement can be calculated). The system also enables containers to be located with high precision, reducing the time and effort to find containers. Occhipinti said: "All the Kvaser interfaces that we tested and have used are optimal products and we are very happy to integrate them in our solutions. Moreover, Datajob has given very effective support, helping in all project phases and providing a very professional service."

When kerb weight is used to calculate the container weight, additional factors influence the container weight accuracy. The definition of kerb weight is the total weight of a vehicle with standard equipment, all necessary operating consumables such as motor oil, transmission oil, coolant, air conditioning refrigerant, and a full tank of fuel, while not loaded with either passengers or cargo". The definition may differ slightly between nations and as an example some European countries include the driver weight of 75 kg. The volume of a typical fuel tank is 500 l. The density of diesel is 0,8 kg/l, which means that the weight of the fuel in a full tank is 400 kg. Since the truck will in some cases arrive in the terminal with a low fuel level the inaccuracy added to the container weight from this factor is actually up to 400 kg. Also the driver's weight is not always

75 kg. Additional inaccuracies can be caused by extra "stuff" in the driver cabin, e.g. a cooler with drinks and food.

Load sensors installed in or on the twistlocks have the advantage that they measure just the weight of the container. The measure that is obtained is the gross mass of the container without the need to subtract tare weight. The inaccuracy specification for twistlock-based systems is typically  $\pm 1$  percent of the full-scale meaning that the measurements are typically within  $\pm 400$  kg, i.e. lower than the process inaccuracies in the discussion above.

When two 20-foot containers are loaded on a truck, the weighing bridge cannot distinguish between the individual weights of the two containers. A possible procedure for obtaining the individual weight is to unload one of ▷

the containers, weigh the vehicle again, and then apply the math to achieve the individual weights.

When spreader twistlock-based systems are employed, individual 20 footers can be weighed as there are sensors in each of the eight twistlocks on a spreader for twin-lifting.

The Bromma weighing solution consists of CANopen load sensors mounted on the spreader twistlocks. The system captures the weight during the crane lifting cycle meaning that there is no extra step to be introduced influencing terminal productivity and space requirement. Bromma's twistlock based container weighing system has been certified to comply with the OIML R51 requirements.

Several companies offer CANopen load sensors. Tecsis provides its F9205 twistlock sensor, which complies with the Solas (safety of life at sea) requirements. This requirement for measuring accurate weight of containers for the marine transportation plays a huge role in driving the demand of container weighing systems. Tecsis's load sensor is shock and vibration resistant and comes in an IP67 enclosure. Besides CANopen, it supports also the J1939 application profile. The CAN interface is available at an M12 connector with a pin-assignment as recommended in CiA 303-1. The sensor is suitable for all kind of spreaders and can be used for reach stacker, straddle carriers, and rubber-tired gantry (RTG) cranes, for example. The measurement range is 0 t to 23 t. The supply voltage is  $8 V_{DC}$  to  $30 V_{DC}$ . The relative linearity error is  $\pm 0,5 \%$ .

Brosa is another supplier of CANopen load sensors for spreaders. The products are designed for harsh environments and temperature compensated from  $-40 \text{ }^{\circ}\text{C}$  to  $+80 \text{ }^{\circ}\text{C}$ . They have a high long-term stability and interference immunity of 200 V/m. The sensors are IP67- or IP69-rated. The CANopen Safety versions comply with performance level (PL) c or d. The supplier can also provide PL e certified sensors. Brosa offers also a force sensor washer with the certificate R60 of OIML (International Organization of Legal Metrology) for container weighing. The international recommendation R60 describes the general and metrological requirements for load cells and how to verify them.

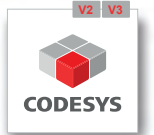

Figure 3: The SCS4 unit is the latest generation of Bromma's spreader controllers connecting the CANopen network embedded in the spreader and the optional CANopen interface to communicate with the crane or straddle carrier (Photo: Bromma)

Lasstec has developed a twistlock load sensing and operational safety system connectable to CANopen networks. It features multiple inputs for twistlock sensors. The safety system is suitable for single and twinlift spreaders – for tandem lifts one system per spreader is used. It can be integrated into new and existing installations without modifying the spreader. The sensors are inserted into a small hole drilled into the center of the

# CAN YOU IMAGINE THE POSSIBILITIES? WE CAN!

## CANopen®



## The PFC200 Controller from WAGO – Compelling, Fast and Intelligent

- High processing speed
- Programmable with CODESYS 2 and e!COCKPIT (based on CODESYS 3)
- Configuration and visualization via Web-server
- Integrated security functions
- Robust and maintenance-free

[www.wago.com/pfc200](http://www.wago.com/pfc200)

# WAGO



Figure 4: Bromma has delivered crane spreaders to 500 terminals in 90 nations, since more than 10 years they use embedded CANopen networks as well as an optional CANopen interface to communicate with the crane controller (Photo: Maersk)

twistlock. The hole is so small that it does not affect the structure of the twistlock. The sensors are totally insensitive to repetitive shock loads, vibrations, EMI, humidity, and they resist overloads. The data is processed on the spreader and sent through the spreader communication channel or sent parallel to the crane PLC and to the TOS. No re-calibration is required throughout the life of the sensors. The system meets the IMO (International Maritime Organization) requirements.

### CANopen as spreader interface

The spreader needs communication to the crane or the straddle carrier. Historically, there are different options. One of them is CANopen. The spreader suppliers have developed the CiA 444 CANopen profile series to achieve interoperability. Bromma and some crane manufacturers were the driving forces.

The Swedish spreader supplier Bromma provides an Anybus gateway for the crane, so that the crane controller can communicate with the spreader controller. The gateway by HMS (Sweden) converts the crane controller interface (e. g. Devicenet, Ethernet, Modbus, Profibus, or Profinet) to CiA 444 or BCAN (Bromma CAN) and vice versa. The IP20-rated gateway comes as kit complete with a 10-m CAN cable and an 120-Ω termination resistor.

Bromma offers also the SCS4 spreader control system. It provides detailed information about the spreader to the operations manager, not just a few LEDs indicating that there is a problem. Accurate diagnostic data is key to shortening downtime duration and eliminating the need for

time-consuming spreader change-outs. Operational information, such as events, alarms, and trend data, is stored in the spreader controller – even after the spreader has been disconnected. This gives service personnel the opportunity to review and analyze data in order to further improve spreader productivity.

The embedded spreader control unit manages all motions of the spreader controlled from the driver's cab over CANopen. All commands are processed safely by the spreader ECU. Lifting allowance is monitored by the ECU and implemented on the reach stacker to ensure safe container handling, for example.

Also other spreader manufacturers support CANopen connectivity. VDL's yard crane spreaders are optionally available with a CiA 444 compliant CANopen interface. The same is valid for the company's ship-to-shore spreaders. ◀



#### Author

Holger Zeltwanger  
 CAN Newsletter  
[pr@can-cia.org](mailto:pr@can-cia.org)  
[www.can-newsletter.org](http://www.can-newsletter.org)



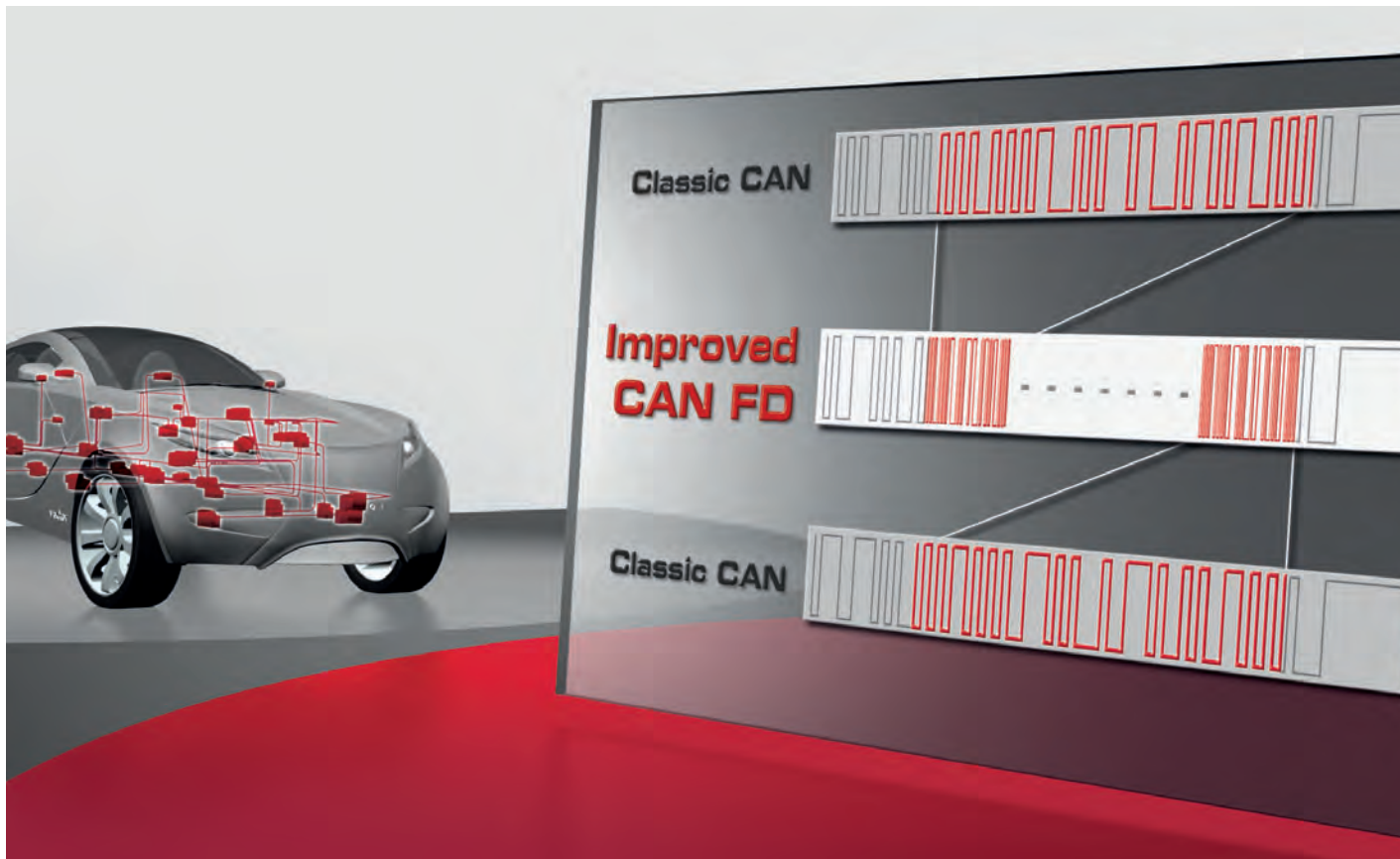

## First Class Solutions for Your CAN and CAN FD Projects

### Your Universal Tool Chain

**Increase efficiency of your projects with the universal tool chain from Vector:**

- > Tools for testing, flashing and calibrating ECUs
- > Flexible network interfaces
- > New all-in-one network disturbance interface
- > High performance oscilloscope for bit accurate signal analysis
- > Easy to configure AUTOSAR basic software
- > Worldwide engineering services and trainings

Information and downloads: [www.can-solutions.com](http://www.can-solutions.com)

**More CAN power by Vector: benefit from 30 years of networking experience.**

# Modules for industrial service robotics

*Pilz has expanded its portfolio by the Service Robotics product range. The modules include initially the robot arm, the control module, and the operator module.*

The essential features are openness, i.e. due to the ROS (Robot Operating System) software framework and the optional CANopen connectivity. Other features include user-friendly operation, and plug-and-play. This enables users to assemble their individual service robot applications.

The robot arm, control module, and operator module together form a package certified by the German statutory accident insurance association (DGUV) in accordance with EN ISO 10218-1 "Robots and robotic devices". They provide the requirements for the implementation of safe robot applications. This simplifies the way to the obligatory CE marking. The areas of application also include pick-and-place applications and modular semi-automated small robot cells in industry.

The supplier has developed the robot arm, which can be loaded with up to 6 kg. Due to 6 axes, a weight of 20 kg and the 24-V<sub>DC</sub> supply voltage it is suitable for use in mobile applications. An example is combination with an automatic guided vehicle (AGV).

## Functional-safe movements

The PRCM control module takes care of the movement and safety control of the robot. According to the plug-and-play principle, users can connect the modules and use them immediately. The control module comes with a CANopen interface. It can be programmed with PLC languages compliant with IEC 61131-3. The run-time system is integrated into the open-source ROS. The supplier provides also ready-to-go application software routines. This software offers functions for sensor processing, evaluation, planning and control of robots.

The PRTM operator module enables the operation of the robot via a graphical user interface. The supplier has developed the operator and visualization system. The



*Figure 1: The shown modules are designed for service robot applications in industrial environments (Photo: Pilz)*

panel offers the functions of operating mode selection, emergency stop and diagnostics. It permits simple setup and teaching of the robot arm via a sensitive touch display.

"Pilz is a technology company that offers complete solutions for safe robotics", explained Susanne Kunschert, Managing Partner of Pilz. "As a system supplier for service robotics, Pilz can support users when implementing their individual robot applications, including the requires safe sensor technology and the required services on the way to CE marking", she added. On the Automatica 2018 fair (June, 19 to 22, 2018) in Munich (Germany), Pilz presents on its booth in hall B4 its service robotics module to the public for the first time. ◀

hz  
[www.pilz.com](http://www.pilz.com)

## CAN Newsletter Online: Related news

The following teasers guide you to brief articles published in the CAN Newsletter Online.



CiA 320

### ***CANopen specification for sleep and wake-up handling***

The nonprofit CiA (CAN in Automation) has released the CANopen specification for sleep and wake-up handling of CANopen devices.

[Read on](#)



Lidar

### ***MEMS-based 3D-sensor***

Innoviz Technologies has launched the Innovizpro lidar sensor. It provides a CAN interface for control purposes.

[Read on](#)



CAN Newsletter magazine

### ***CAN connectable-sensors look optimistic into the future***

The trend to more complex devices is ongoing. This is also true for sensors as reported in the latest CAN Newsletter magazine. Thus they require more sophisticated communication interfaces.

[Read on](#)



Smart gripper

### ***Designed for human/robot collaboration***

Two members of the Co-act gripper family by Schunk are optionally equipped with CAN interfaces. Recently, the product series received the Hermes award.

[Read on](#)



CAN Newsletter magazine

### ***Service robots: Still just an academic topic?***

There are two articles in the 25th CiA anniversary issue of the CAN Newsletter magazine, which informs about service robots.

[Read on](#)



Integrated electronics

### ***Force and moment sensor with CAN***

Schunk has added the FCT to its range of sensors. It is a force/moment sensor for hand-operated robots or service robots and can also be used in simpler applications.

[Read on](#)



Expertdays

### ***Mobile robots are the future***

Schunk has organized the 6<sup>th</sup> Expertdays in its facilities in Lauffen (Germany). More than 100 service robot experts participated in this annual 2-days event, which took place end of February. Some of the presented robots and sub-systems use embedded CAN-based networks.

[Read on](#)

# POSITAL

## FRABA

### DYNAMIC INCLINOMETER



NEW

### **Inclinometers with Dynamic Acceleration Compensation**

Compensation of External Accelerations

Clean Angle Measurement During Dynamic Movements

Optional Output of Acceleration and Rate of Rotation

IP69K Protected to Meet the Requirements of Mobile Equipment

Accuracy 0.5° During Dynamic Movements

Available with CANopen Interface

### **POSITAL's Accessories**



Rugged Connectors and Cables

[www.posital.com](http://www.posital.com)

# Networking with CAN FD - What about testing?

For CAN FD, a large part of the test specifications of car manufacturers are still valid without restriction. The existing test systems are to be adapted and upgraded both in the hardware and software area.

The introduction of new technologies in the automotive industry is a risk and cost-intensive undertaking. Particularly in the area of vehicle networking this often means a balance between proven mechanisms, growth of functions and increased bandwidth thanks to more advanced bus systems. The reliability achieved over the past few years is always the standard and must not be put at risk under any circumstances. The demand for networking tests has enormously increased of late and represents a significant step in the approval process for hardware and software components of new vehicle generations.

The Classical CAN network has proven itself to be an efficient and robust communication medium to date. With the "FD - Flexible Data rate" idea and the thereby increased bandwidth the raison d'être of CAN system architectures is significantly extended. The changes in the log, the higher data lengths and various bitrates require new or adapted test cases and test systems.

## Network test

The methods for testing the network functions of bus participants are defined in the specifications and testing standards of the individual OEMs. Alongside the bus physics various controller parameters such as bitrate and scanning time are to be tested. By assessing the bus communication, the transmit messages of the control unit are tested against the data definition (ID < DLC, cycle time, signal tests for counters and checksums, for example, etc.).

Typical test cases include the determination of the working voltage limits, power consumption, transmit start as well as the reactions to faults in the working voltage in the form of pulses and ramps. Testing the CAN error management represents a significant testing task in the CAN control unit test. For the inspection of the bus-off handling, transmit messages of the control unit are disrupted and send and waiting phases, re-initialization and readiness to receive in the waiting phases are evaluated. The test cases for network management conform to the network management type used (Osek-NM, NMHigh, Autosar) and check state transitions, wake causes, upholding the idle bus and the timing, for example. The test complex

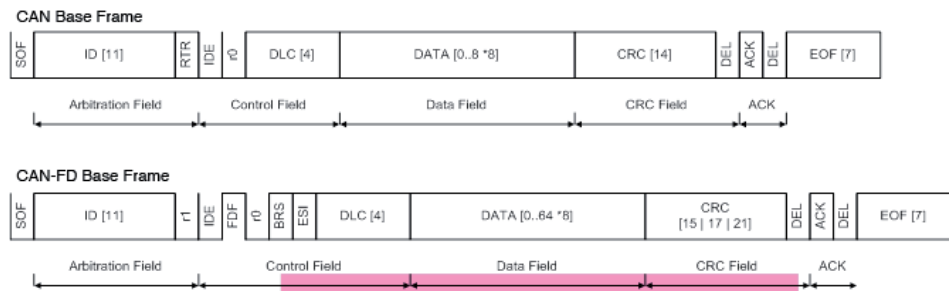

Figure 1: CAN frame layout (Photo: Goepel)

of the onboard diagnosis contains, for example, the test of the transport log, the CAN error management (start of monitoring, voltage thresholds, message failure, signal errors, busoff), and the checking of the diagnosis service.

CAN FD is essentially an expansion to the log level. That's why most of the points of the test specifications for Classical CAN are also valid for CAN FD. Several features or test cases to be additionally carried out should be briefly explained in the following.

### Compatibility

CAN FD is completely compatible with Classical CAN, i.e. every CAN FD controller can send and receive Classical CAN frames. However, controllers that only support the CAN standard, cannot decode CAN FD frames.

In the CAN FD acceptance test, FD frames regardless of the type of frames sent or received itself via the control unit, must always be correctly acknowledged (ACK).

### Data length

The maximum application data length was increased from 8 to 64 databytes. These values must be checked for all messages sent. This occurs in the same way as in the Classical CAN, with trace recording and analysis under varying conditions and the subsequent test against the specifications from the data definition. Incorrect data lengths can lead to functionality limitations for the recipient and must

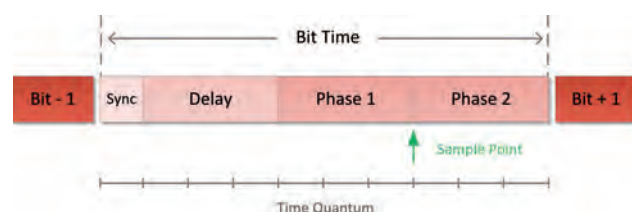

Figure 2: CAN bit timing (Photo: Goepel)

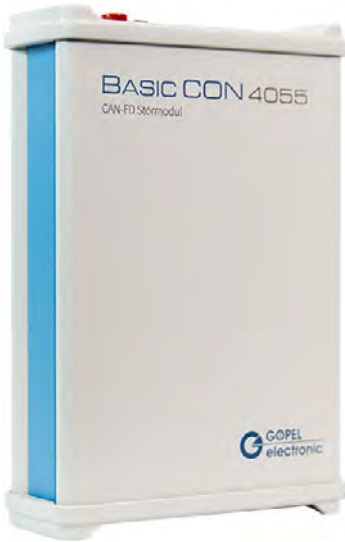

Figure 3: Basic CON 4055 stress and trigger module (Photo: Goepel)

therefore be simulated in the corresponding tests cases for fault recognition.

#### Bitrate

The significant parameter for fault-free communication on the CAN network is the bitrate. Unlike Classical CAN, CAN FD works with flexible bitrate, i.e. with varying transfer speeds within a frame. During the arbitration phase data is sent at up to 1 Mbit/s and at up to 10 Mbit/s during the data phase.

A typical combination, for example, is 500 and 2000 kbit/s. Hardware-based solutions are suitable for transmission-side tests. This makes it possible to measure both bitrates at the same time and continuously in one or more frames. High-resolution, CAN FD-triggerable oscilloscopes are also suitable for the illustrative measurement of a frame.

#### Bit Rate Switch (BRS)

The new BRS bit in the control field of the frame signals sending with a high bitrate (recessive bit) or low bitrate (dominant bit). The frames sent of a control unit are compared with the manufacturer specifications or the data definition via trace recording and analysis and assessed. Generally, all FD frames must always be sent with a high bitrate. On the receiving side control units must not differentiate between fast and slow frames. For this, individual or all FD reception messages are sent both fast and slow for a certain time period. This must neither lead to error frames on the bus, nor the occurrence of additional error memory entries.

#### Error State Indicator (ESI)

The ESI bit in the CAN FD shows the current error condition of a CAN FD controller. A dominant value signals error active, a recessive value error passive. Therefore, in the test cases regarding error management for CAN FD, alongside the usual test cases for the reaction to reaching bus-off, the two other error conditions must also be enforced and assessed. A flexible, configurable stress and trigger module, which can disrupt any CAN and CAN FD messages, is necessary for this.

#### Bitrate switching

Switching from slow to fast bitrate takes place at the sampling point of the BRS bit, switching from fast to slow bitrate at the sampling point of the CRC delimiter or directly after recognizing an error. Error frames are therefore always sent with the nominal (slow) bitrate. Bitrate switching must be tested for the sending and receiving side fault recognition.

## All you CAN plug



CANopen<sup>FD</sup>

CAN<sup>FD</sup>

www.esd.eu

### CAN FD and CAN classic product line 402

Interfaces with various form factors:

- CAN PCI Express<sup>®</sup> Mini
- CAN PCI and PCI Express<sup>®</sup>
- CAN USB
- CompactPCI<sup>®</sup> and CompactPCI<sup>®</sup> Serial CAN
- XMC and PMC CAN (optional IRIG-B)

The boards are available in **different versions** from 1 to 4 channels as CAN FD or CAN classic models.

The entire series of CAN FD interfaces is controlled by the **high performance esdACC** implemented in an Altera-FPGA.

esd electronics supports the **realtime operating systems** VxWorks<sup>®</sup>, QNX<sup>®</sup>, RTX, RTOS-32 and others as well as Linux<sup>®</sup> and Windows<sup>®</sup> 32/64 Bit systems.

Efficient **CAN monitoring and diagnostic tools** for Windows (CANreal, COBview, CANplot, CANscript and CANrepro) are **included**.



esd electronics gmbh  
Vahrenwalder Str. 207  
30165 Hannover  
Germany  
Tel.: +49-511-3 72 98-0  
info@esd.eu  
www.esd.eu

US office:  
esd electronics, Inc.  
70 Federal Street - Suite #2  
Greenfield, MA 01301  
Phone: 413-772-3170  
us-sales@esd-electronics.com  
www.esd-electronics.us

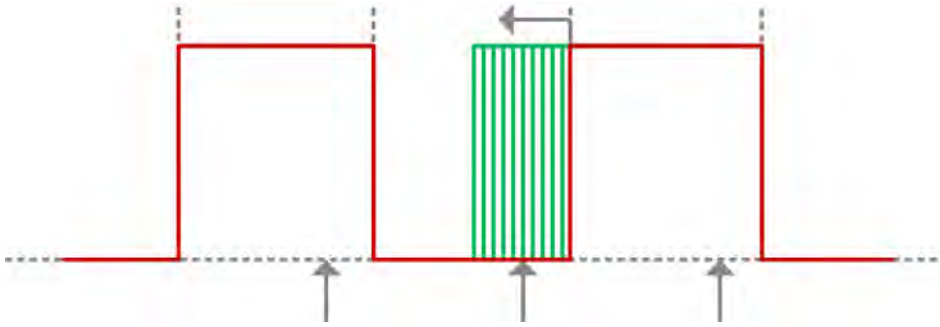

Figure 4: Illustration of the principle of scanning time determination (Photo: Goepel)

#### Scanning time

A CAN FD controller determines the value of each sent or received bit at a firmly defined point in time. This value must be configured according to the manufacturer specifications. Due to bitrate switching, there are two different such scanning times for CAN FD. The scanning time can be determined with the help of various processes, including with the process according to patent DE102009039200 A1.

For CAN FD, a significantly higher level of precision in frame generation and an adjustment of the signal generation for the measuring of both scanning times of all possible frame types is required (Classical CAN/CAN FD, base/extended, ISO/non-ISO).

#### Hardware

The type and scope of the control unit tests to be carried out determine the required hardware resources. The individual communication parameters must be moved to the limits of the permissible tolerance range and beyond it in order to be able to determine the safety and error tolerance of the communication with a control unit.

#### Restbus controller

The communications matrix for Classical CAN or CAN FD can be optionally defined in the DBC, Fibex, or Autosar system description formats. The restbus controller of the Goepel Electronic platform Series 61 has a modular and therefore scalable test resources concept. This makes flexible adjustment to the respective test object possible. For CAN FD communication a TJA1044GT transceiver is



Figure 5: Examples of Classical CAN, CAN FD, LIN, Flexray, Ethernet network test systems (Photo: Goepel)

used in combination with the integrated Bosch CAN FD IP core and allows a bitrate of up to 10 Mbit/s. The functionalities for restbus simulation (frame-based or as per Autosar), transportation and diagnosis logs or network management were correspondingly expanded for CAN FD.

#### Stress, trigger, and analysis module

Using the stress, trigger, and analysis module Basic CON 4055 the Classical CAN/CAN FD communication can be specifically manipulated and analyzed. This creates the opportunity to carry out precise log tests. The Basic CON 4055 can disrupt any Classical CAN/CAN FD messages and has more than 250 independent message triggers for this on four configurable ports as well as trigger input and output for the use of external resources. The analysis functionality also includes bitrate measurement for Classical CAN/CAN FD communication. In the case of CAN FD, there is the option to measure both bitrates at the same time (arbitration and data phase). The module is used in the current interface and network testers.

#### Signal generator

The determination of the scanning time touches upon error handling in the data link layer in the process according to DE102009039200 A1. The sender used here must be in a position to generate modified Classical CAN/CAN FD messages. The manipulation of the message takes place via a partial inversion of an individual bit in the data area. The Classical CAN/CAN FD participant then reacts to recognized CRC errors with an error telegram. In order to carry out the determination at precisely one percent, a signal generator is used, which can send the test signal in a corresponding resolution, precision, and speed.

## Summary

For CAN FD, a large part of the test specifications of car manufacturers are still valid without restriction. In some test cases upgrades are required, others are completely newly added. The existing test systems are to be adapted and upgraded both in the hardware and software area. In hardware, this mainly affects the restbus controllers and stress and trigger modules and, in software, the complete integration of the CAN FD log. ◀

#### Authors



Steffen Rauh, Andreas Schmidt  
Goepel Electronic  
[presse@goepel.com](mailto:presse@goepel.com)  
[www.goepel.com](http://www.goepel.com)

# Powerful Control Units for High-Safety Applications: HY-TTC 500 Family

## Flexibility & Usability

- Single controller for whole vehicle for centralized architectures
- Extensive I/O set with multiple software configuration options per pin
- Open programming environments C, CODESYS® V3.x and CODESYS® V3.x Safety SIL 2

## Safety & Robustness

- TÜV-certified according to IEC 61508 (SIL 2) and EN ISO 13849 (PL d)
- ISO 25119 AgPL d certifiable
- CODESYS® Safety SIL 2 including support for CANopen® Safety

## Connectivity & Performance

- Up to 7 CAN interfaces
- Ethernet for fast download and debugging purpose
- 32 bit / 180 MHz TI TMS570 dual core lockstep processor (ARM architecture)



# Functional GUI testing of IVI systems

*Software-based embedded systems operated via GUIs are playing an ever more important role in automotive development. Testing both individual software components and the user interface is required.*



(Photo: Vector)

In-vehicle infotainment (IVI) systems are part and parcel of today's automotive sector. Their graphical user interfaces (GUIs) serve as the "face to the customer," and externally represent a variety of embedded vehicle applications. Organizations need to adopt and apply measures for quality assurance to the distribution of software-based interfaces, as complex logic (which poses new challenges to the development process) is required to operate embedded systems. Trends such as the expansion of functionality using new software components and flexible adaptation of the user interface can further increase this complexity. As a result, the testing phase of user interface development continues to take on greater importance over time. Verifying IVI systems requires an interdisciplinary approach: one that's capable of handling the complexity resulting from the interplay between software-based user interfaces and embedded systems. To enable efficient testing of the overall system for this purpose, Testplant and Vector have combined their domain tools — Eggplant Functional for GUI tests and CANoe for ECU testing.

Embedded systems are ubiquitous in everyday life today, and are spreading especially quickly in the automotive sector. To operate vehicles, users rely on the functions and data of these systems, which increases the importance

of GUIs as the main element of interaction between human and machine.

In vehicles, these interfaces used to be primarily hardware switches but are now being replaced with software implementations because they can be used in a wider variety of ways and can even be easily changed and expanded at runtime. These IVI systems are largely being developed to be the main interface in the vehicle, as they cover an increasing number of functions and access the vehicle on a deep level (Figure 1).

To cope with this increasing importance, functionality must already be ensured during the early stages of development. Frequently, the target hardware is not yet available, or is at least incomplete at that point in time. So, validation must often occur in a purely virtualized environment or on an isolated ECU for each remaining bus simulation.

The interfaces, users want, are characterized by clear and comprehensible visualization of the underlying vehicle applications — despite their complexity — as well as by intuitive and easy operation (i.e., usability). Ultimately, the goal is to make IVI systems as smart as smartphones, which involves highly responsive, touch-based infotainment interfaces with a broad spectrum of functions that ▶





Figure 1: In-vehicle infotainment - the main interface in the vehicle (Photo: Vector Informatik)

also need to be ensured. Customers always expect the technology of the main unit to be state of the art, both in terms of the operating concept and the supported peripherals and audio/video codecs used. The result is a high update frequency which peaks when the car is connected and the software is updated in the field. These framework conditions highlight the requirements for repeatable, automated, and maintainable tests.

### An interdisciplinary approach

Satisfying these requirements needs an interdisciplinary approach that combines the tools from both classic GUI testing and ECU testing to ensure comprehensive verification in every stage of development. Eggplant Functional,

the software from Testplant for functional GUI testing, enables embedded software applications to be tested based on their user interfaces. With respect to testing on the program code or function level, a greater depth of testing is ensured here. Test automation draws on image and text recognition algorithms to detect buttons and indicators. Should a button be activated, for example, its position is identified through image recognition, and a button press initiated. The transfer of screen content and the initiation of user interactions occur on the system level through remote-control mechanisms such as Virtual Network Computing (VNC), Remote Desktop Protocol (RDP), and Keyboard-Video-Mouse (KVM) over IP. VNC and RDP are protocols common in the PC domain for transferring screen content and keyboard and mouse input. KVM switches typically rely on the hardware level for implementation of the same functionality in order to transfer the input and output information. Changes to the software to be tested, which are made to ensure testability, are thus unnecessary. A non-invasive approach like this ensures that changes, which are otherwise only carried out to test the software, have no effect on the actual test. Since remote-control mechanisms can now be found in every commonly available operating system (Android, iOS, Linux, QNX, VxWorks, Windows, etc.), any ECUs can be tested using this approach. Eggplant Functional runs as a distributed system, and the host application with the test sequence control is executed on a conventional PC for this purpose. Only the remote-control component is required on the ECU to be tested. Using ▶



Sontheim

Your reliable partner for innovative CAN systems

From design over implementation to testing

- ▶ Mobile or stationary CAN Interfaces in various form factors with WLAN, Bluetooth, Ethernet, USB and more
- ▶ Robust CAN Gateways and Data Logger with up to 256GB of built-in NAND-Flash-Memory
- ▶ Rugged ECUs for controlling, telemetry services and diagnostic application
- ▶ Monitoring and analyzing - our modular software tools for efficient fieldbus diagnostics
- ▶ Searching for a modular diagnostic tool based on standards? Have a look on our MDT! <http://www.sontheim-industrie-elektronik.de/en/products/automotive/diagnostics-tools/>

**MDT 2.0**  
Next Generation Diagnostic Tool  
Based on ODX and OTX Standard

Sontheim Overview and Portfolio:

Automotive Automation Diagnostics Software-Development Hardware-Development

**We live electronics!**  
[www.sontheim-industrie-elektronik.de](http://www.sontheim-industrie-elektronik.de)

**DE Sontheim Industrie Elektronik GmbH**  
Georg-Krug-Str. 2, 87437 Kempten  
Tel: +49 831 57 59 00-0 - Fax: -73  
info@s-i-e.de

**US Sontheim Industrial Electronics Inc.**  
One West Court Square, Suite 750  
Decatur, GA 30030  
Phone: +1 (563) 888-1471

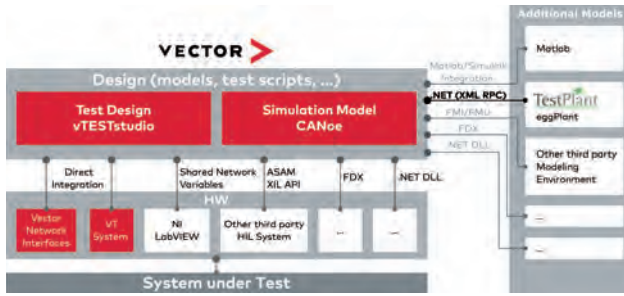

Figure 2: CANoe as an open environment (Photo: Vector Informatik)

various interfaces, Eggplant Functional can interact with test automation systems of other manufacturers and is thus designed as an open system.

## The test environment

The CANoe software from Vector enables remaining bus simulation for the ECU to be tested and the analysis of bus sizes. It also provides a testing environment which includes test sequencers and test reporting. The tests themselves are created by Vector in vTeststudio, the authoring tool for editing test sequences for embedded systems. Tabular, graphical, and programming language-based (CAPL/C#) test notations and design methodologies are available for this purpose. CANoe (CAN open environment) was designed explicitly as an “open environment” and offers a host of interfaces for linking external programs (Figure 2). This includes, among others, Vector’s own UDP-based Fast Data Exchange (FDX) interface, the Asam XIL API standard, the Functional Mockup Interface (FMI) and Matlab. External DLLs can also be integrated, an option used to connect Eggplant Functional to CANoe.

Eggplant Functional provides an access option for external applications over an XML RPC interface and is thus run as Eggdrive in a mode without a GUI. The interface makes it possible to call functions and test scripts, as well as to read back partial, individual results or the entire test report. Testplant already offers an implementation in the form of a .NET assembly for use of the XML RPC interface. This enables linking to CANoe/vTeststudio (Figure 3). Encapsulating the necessary calls in a C# test library and reproducing the test results in the CANoe test report yields an easy-to-use interface for the combination of CANoe and Eggplant Functional. The test designer creates the ECU tests in the vTeststudio environment they are familiar with and draw on the functions of Eggplant Functional in the same way as the scope of functions belonging to CANoe.

## The benefits

The integrated approach from Vector and Testplant provides the user with a testing environment in which to monitor and stimulate the GUI of the ECU, as well as to stimulate and analyze the values transferred on the vehicle bus. From the point of view of the test developer, the level on which they access the information does not play a role.

Because it is also possible to initiate existing Eggplant Functional test scripts, the scripts available from the pure user interface test can be reused in an integrated, functional

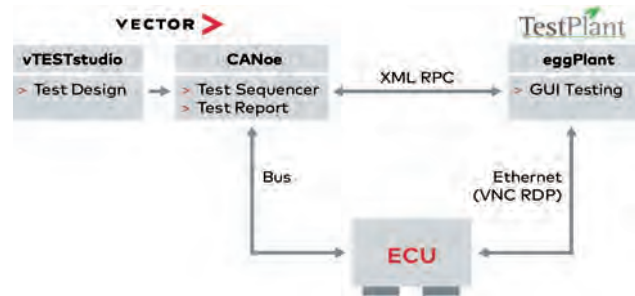
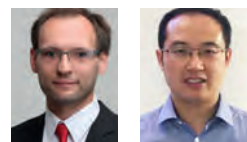

Figure 3: A chain of tools for integrated, functional GUI testing (Photo: Vector Informatik)

GUI test. In the combined use case, domain specialists can also use the tools already familiar and available to them. Such an approach increases the testing depth and degree of test automation, and also ensures deep and comprehensive functional testing of the ECU, even in the event of more frequent software releases. Such a test setup makes it possible to already ensure an isolated ECU, including the user interface during the early stages of development. ECUs which communicate with the ECU to be tested are simulated by CANoe and do not actually need to be present here. Functional GUI tests thus enable functionality to be ensured with a transparent hardware expenditure from very early on, which is also ideal for creating a development environment with continuous testing. It also provides the option for daily builds, for example, and enables early responses to problems in new software releases—facilitating frequent software releases and short development cycles, and ensuring a timely response to new requirements or framework conditions.

## Conclusion

Software-based embedded systems operated via GUIs are playing an ever more important role in automotive development. To satisfy quality assurance, testing both individual software components and the user interface is required. Thanks to their open interfaces, Eggplant Functional and CANoe test automation tools are ideal to automatically verify the functionality of embedded systems — completely and reliably. Domain specialists can implement tests in their preferred environment and integrate them into an overall test suite — eliminating expenses associated with creating additional tests. This, in turn, enables shorter development cycles with frequent software releases, and a competitive advantage for the OEM or supplier. ◀



## Authors

Sebastian Mezger  
Vector Informatik  
[info@vector.com](mailto:info@vector.com)  
[www.vector.com](http://www.vector.com)

Mingzhi Deng  
Testplant  
[sales@eggplant.io](mailto:sales@eggplant.io)  
[www.testplant.com](http://www.testplant.com)

# EVERYONE CAN

*Introducing the new ValueCAN 4 family of tools.*

- Great value at a great price - starting at less than €200
- Options for CAN FD, CAN, Ethernet, and LIN
- Rugged aluminum case and heavy duty strain relief
- Sealed body and connector
- Small size, easy to keep with your laptop
- Real-time acceleration, bus isolation, high-speed flashing, standalone operation, USB-powered

Read more: [www.intrepidcs.com/vcan4](http://www.intrepidcs.com/vcan4)



**INTREPID CONTROL SYSTEMS GMBH**

USA UK Germany Japan Korea China India Australia

+49 (0)721 6633703 -4 [icsgermany@intrepidcs.com](mailto:icsgermany@intrepidcs.com)

# Accurate leveling even during acceleration, braking, and cornering

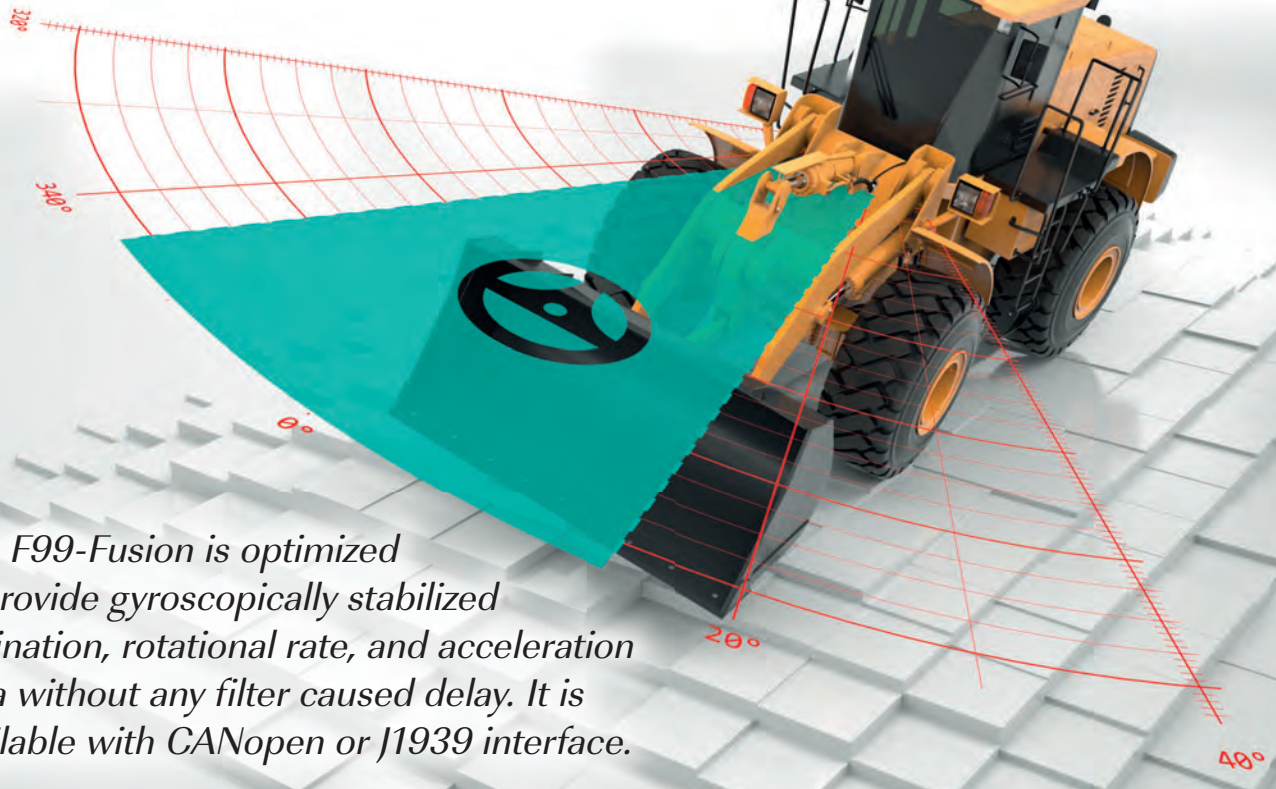

(Photo: Pepperl+Fuchs)

*The F99-Fusion is optimized to provide gyroscopically stabilized inclination, rotational rate, and acceleration data without any filter caused delay. It is available with CANopen or J1939 interface.*

At the heart of the F99-Fusion is the adaptive sensor fusion algorithm. This algorithm has been developed and implemented to detect orientation in three dimensions with extremely effective compensation of external acceleration. Multiple output values available for selection (acceleration, inclination, yaw rate, euler angle, euler vector, quaternions, etc.) and programmable filters allow the F99-Fusion to adapt to the relevant application. J1939 or CANopen interfaces are available.

In order to level mobile work equipment such as construction machinery, work platforms or trucks, inclination sensors are required that are able to function with precision when machines are moved in a dynamic fashion. Inclination sensors commonly found on the market adopt

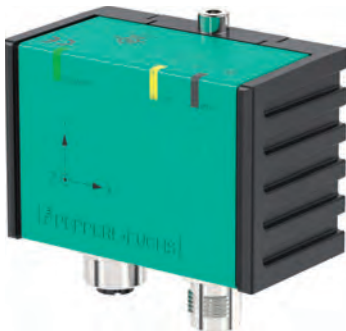

*Figure 1: 360° inclination, rotational rate, and acceleration measurement in six axes in one device (Photo: Pepperl+Fuchs)*

different measurement principles based on acceleration. However, due to the physical principle of these sensors, they are unable to differentiate between external forces of acceleration and acceleration caused by gravity. As such, the measurements produced by these sensors when moving off or braking, for example, are often erroneous.

The F99-Fusion makes use of both 3-axis acceleration elements and 3-axis gyroscope elements. With the company's sensor fusion algorithm, the various items of information provided by these elements – all of which serve to supplement one another – are intelligently linked. This optimizes the performance of the system as a whole. As a result, external forces of acceleration are cut out in a targeted manner, without any impact on the reaction time. Hence a fault-free inclination detection is also achieved in dynamic applications.

Both the raw data from the individual sensor elements as well as various sensor fusion data are available to the user. These are calculated in real-time by intelligent sensor fusion algorithm and can be used immediately. The product is also optimized for use in harsh outdoor applications, both mechanically and in terms of EMC, making it ideal for performing inclination measurements on mobile work equipment. ◀

#### Author

Stefan Horvatic  
Pepperl+Fuchs  
[info@de.pepperl-fuchs.com](mailto:info@de.pepperl-fuchs.com)  
[www.pepperl-fuchs.com](http://www.pepperl-fuchs.com)



## CAN Newsletter Online: Sensors

The CAN Newsletter Online has reported briefly about CAN-connectable sensors.



### Weighing system **Digitizer for load cells features CANopen**

Laumas (Italy) has introduced the LCBCANopen digitizer. It transforms an analog load cell (output mV/V) into digital and can also be used on existing load cells or strain gauge sensors.

[Read on](#)



### Encoder and inclinometer **Comes with CANopen and CANopen Safety interface**

FSG (Germany) has developed the MH64-II-CAN/Mems/GS65 series of rotary encoders with integrated tilt sensor. The housing is IP67-rated.

[Read on](#)



### Draw-wire sensor **IP69K-rated device complies with CiA 406**

Waycon has developed the MH60 draw-wire sensor. It features CANopen connectivity..

[Read on](#)



### Encoder **Multi-turn sensor for safety applications**

FSG (Germany) has launched the MH64-II-CAN/MU series of functional-safe rotary encoders. The product addresses price-sensitive applications.

[Read on](#)



### Non-contact encoder **Rectangular housing can be mounted on flat surfaces**

The PE18-BX Proxencoder by Joral is a rotary encoder. It comes with J1939 interfaces, but not with CANopen support.

[Read on](#)



### Wind sensor **Measuring speed and direction with CANopen**

The precise measurements of wind speed and wind direction are prerequisite for maximum energy generation from a wind turbine. Mesa Systemtechnik (Germany) has unveiled its Sonic Anemometer with CANopen output for this purpose.

[Read on](#)

# CAN Products for your requirements



**CAN-Repeater  
CRep DS 102**



**CAN-LWL-Router  
CG FL**



**CAN-Repeater  
CRep S4**

- Repeaters for different network topologies
- Stub line connection of networks segments
- Optical fibre connection of copper networks
- Cost effective star repeater with 4 channels

**EMS**  
Thomas Wünsche

Sonnenhang 3  
D-85304 Immünster  
Tel.: +49-8441-49 02 60  
Fax: +49-8441-8 18 60  
[www.ems-wuensche.com](http://www.ems-wuensche.com)



## CAN in aquaplaning warning system

*In future, software will detect the risk of aquaplaning in time and avoid accidents and frightening moments. Continental uses networked cameras and CAN-connected tire sensors with smart software for detecting imminent aquaplaning.*

Continental is working on an automatic system to warn of the risk of aquaplaning. This loss of grip on extremely wet roads dramatically reduces the ability to control vehicles and presents a major accident risk. In future, the aquaplaning warning system based on fusion of camera data and tire sensor data will detect impending aquaplaning situations early on. This means that drivers will be warned in time and can better adjust their speed in advance. An initial production of the technology, which is currently in predevelopment, is conceivable in a next generation of vehicles, according to the Continental technology experts. The hardware and software for the aquaplaning warning is developed in Frankfurt, Hanover, and Toulouse.

“Even with the best tires, sudden aquaplaning is always a frightening moment and can mean the danger of an accident. We are developing a high-performance technology based on sensor information and software that detects a potential risk of aquaplaning and warns the driver in time,” explained Frank Jourdan from Continental.

In relation to further research into the aquaplaning effect and the development of the aquaplaning warning system, the Tier-1 supplier points to the importance of sufficient tread depth for road safety. As aquaplaning depends on the tread depth of the tires, the depth of the water on the road and the driving speed, Continental recommends

renewing summer tires with a remaining tread of 3 mm. If the tread depth is any less, there is a much higher risk of aquaplaning. Experts generally advise drivers to reduce their speed on wet roads and in rain.

### Cameras are the key to early warning of aquaplaning

Aquaplaning occurs when the tread cannot quickly enough deflect the water from the road. To detect this excessive water displacement, Continental relies on images from the surround-view cameras. These wide-angle cameras are installed both in the side mirrors, the grill, and on the rear of the Continental development vehicles. “When there is a lot of water on the road, the camera images show a specific splash and spray pattern from the tires that can be detected as aquaplaning in its early phase”, explained Bernd Hartmann, project manager at Continental in Frankfurt.

### Tire sensors feel risk of aquaplaning

In addition to the camera data, the supplier headquartered in Germany also plans to use information from the tires to identify the risk of aquaplaning. Here, the sensor signals are analyzed directly in the tires. “We use the accelerometer signal from the electronic-Tire Information System (eTIS) ▶

## PC/CAN Interfaces

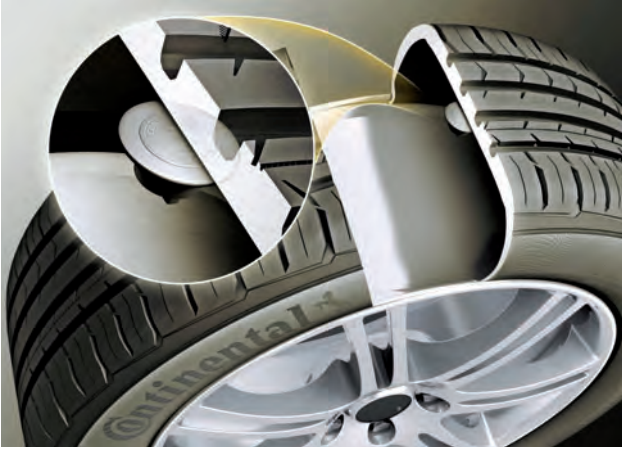

Figure 1: Being integrated directly into the inner liner of the tire means that the eTIS sensor offers data to the CAN-based receiver unit that can be forwarded to interested ECUs (Photo: Continental)

to look for a specific signal pattern”, said Andreas Wolf from Continental. As the sensor can also identify the tire’s remaining tread, this data can be used to determine a safe speed for specific wet road conditions and pass this on to the driver. In addition to the normal functionality and benefits of Continental’s Tire Pressure Monitoring System solutions, the eTIS provides functional scalability. Vehicle manufacturers can choose their own functional strategy according to their specific needs.

“In a typical vehicle architecture, the tire-sensor receiving unit communicates the tire specific information via a CAN interface to the ECU carrying out the fusion with the processed camera information. An example for this ECU can be a Vehicle Stability Control Unit,” stated Sebastian Fillenberg from Continental.

In the future, it will be possible to evaluate all sensor data in one electronic control unit (ECU) for the aquaplaning warning system. If the system detects a danger at the current speed, the driver will be notified of a safe speed. This is where vehicle connectivity has its ace in the hole. Vehicles that are still far behind a potential aquaplaning spot can be informed of the danger immediately via the vehicle-to-vehicle communication and the digital map based on the electronic horizon. This is how the traffic control systems also receive information about relevant danger areas.

The aquaplaning warning system is especially important for automated vehicles. They must avoid aquaplaning situations without human driving experience.



### Easy CAN connection for your application



- Interface for your control or monitoring application as well as for the IXXAT tool suite
- All PC interface standards supported with one uniform driver interface
- Drivers (32/64 bit) for Windows7/8/10, Linux, QNX, INtime, VxWorks and RTX
- APIs for CANopen and SAE J1939



Discover more:  
[www.all4CAN.com](http://www.all4CAN.com)



CAN-IB 100/200/PCle  
1-4 x CAN (HS/LS)  
CAN FD available



CAN-IB 130/PCle 104  
2-4 x CAN (HS)  
CAN FD available



CAN-IB 120/PCle Mini  
1-2 x CAN (HS/LS)  
CAN FD available



CAN@net NT 420 - Ethernet  
PC-Interface, Bridge, Gateway  
2 x CAN FD, 4 x CAN



CANblue II - Bluetooth  
PC interface, bridge, gateway  
1 x CAN (HS)

hz

[www.continental-corporation.com](http://www.continental-corporation.com)

HMS Industrial Networks GmbH  
Emmy-Noether-Str. 17 · 76131 Karlsruhe

+49 721 989777-000 · [info@hms-networks.de](mailto:info@hms-networks.de)  
[www.anybus.com](http://www.anybus.com) · [www.ixxat.com](http://www.ixxat.com) · [www.ewon.biz](http://www.ewon.biz)





(Photo: Roboteq)

## The CANopen logical device approach suites mobile robots and AGVs

*CANopen devices can support up to eight instances of logical devices. They can implement the same or different profiles. A typical example, is a multi-axes controller. It targets mobile robots and automatic guided vehicles (AGV).*

The arrangement of the CANopen dictionary is structured. All parameters in this list are addressable by means of a 16-bit index and an 8-bit sub-index. The index range from 6000<sub>h</sub> to 9000<sub>h</sub> is assigned to standardized profile parameters. These parameters can be process, configuration, or diagnostic data. This area is logically divided into eight blocks of 800<sub>h</sub> addresses. In each of these blocks can be one CANopen profile implemented. This means, eight different profiles can be implemented. Alternatively, you can implement the same profile. Then you have multiple instances of this profile, but a logical device can not be distributed to several CANopen devices.

### Two- and three-axes controllers

Roboteq's motion controllers are an example of using this CANopen feature. Mobile robots need two motors to move and steer, and Roboteq can make this work with a single controller. Compared to the traditional single-motor controller approach, the dual-channel motion controller is simpler, cheaper, and easier to integrate and maintain. The two motors are coordinated within the controllers, resulting in superior and safer drive characteristics. Using two of such controllers can team up to drive four motors with Mecanum wheels to move omnidirectional robots.

The FDC2360 is even able to drive directly three DC motors up to 60 V and 60 A. The motion controller targets mobile robots and automatic guided vehicles (AGVs).

The product comprises a Basic language interpreter capable of executing over 50 000 instructions per second. This feature can be used to write scripts for adding custom functions, or for developing automated systems without the need for an external PLC or host controller. The motors may be operated in open- or closed-loop speed or position modes with a 1-kHz update rate.

The second and third instance of the CiA 402 profile starts at 6800<sub>h</sub> respectively 7000<sub>h</sub>. This means the controlword of the second logical drive has the address 6840<sub>h</sub> respectively 7040<sub>h</sub> for the third logical axis. The 512 PDOs (process data objects) are also assigned to the logical devices. The first 64 PDOs belong to the first logical devices, etc.

### Robot I/O extender

The company offers also a robot I/O extender with CANopen interface. This device is companion of Roboteq's motion controller. The Riox provides a 9-degree of freedom (DoF) accelerometer, gyroscope, and magnetometer. That's not including, of course, its fusion algorithm for creating a precise attitude and heading reference system (AHRS). The Riox electronic compass and artificial horizon functionality, when added to the motion controllers, opens a world of applications in sea, land, or airborne unmanned robotics vehicles.

A self-balancing robot or scooter is easy to create when you know its inclination with precision and in real-time. The 3-axis gyroscope and accelerometer work together to sense and compute this information. Communication with the motion controller ensures the robot's quick response and stability.

The Riox features 12 inputs, each of which can be individually configured as digital, 0-V-to-5-V analog, or as a pulse input. In the pulse mode the inputs can capture pulses from RC radios, frequency, duty cycle, or counts from quadrature encoders. These inputs can also be used to connect up to 12 ultrasound distance sensors for 360-degree obstacle detection and environment mapping. The 12 digital inputs can also be configured to generate a variable width pulse for driving RC servos. This allows ▶



to use third-party servos for building low cost robot arms, pan & tilt heads, gimbals, or anything else what needs to be move. Two analog outputs and up to 16 industrial-grade and protected outputs are available for connecting lights, solenoids, buzzers, or any module with a 1-A load.

The Riox device combined with motion controllers, the supplier's magnetic guide sensors, and battery management systems is a solution for mobile robots and AGVs. The device can be programmed using the built-in programming language. This means the I/O signals can be pre-processed. Via CANopen, the product can be connected to PLC or any other host controller. In addition, the supplier supports the proprietary RoboCAN application layer. ◀

hz  
[www.roboteq.com](http://www.roboteq.com)

## CAN Newsletter Online: Roboteq



Motion controller  
**Driving up to three DC motors**  
 Roboteq offers the FDC3260 motion controller, which supports the CiA 402 profile. It is able to control up to three motors.

[Read on](#)



Magnetic guide sensor  
**Suitable for line following robots**  
 Roboteq (USA) has introduced a sensor capable of detecting and reporting the position of a magnetic field along its horizontal axis. The CAN-interface is available at the M12 connector.

[Read on](#)



Motor controller  
**Networking up to 127 drives via CAN**  
 Roboteq has introduced the RGLB1860 and RGLB1896 motion controllers for brushless DC motors. They are suitable for electric vehicles, material handling robots, electric boats, or agricultural robots.

[Read on](#)



I/O expansion card  
**With optional inertial measurement unit**  
 Roboteq (USA) has introduced the I/O Extender (Riox) module. It is an I/O expansion card with an optional inertial measurement unit. It integrates with Roboteq motor controllers.

[Read on](#)

## CAN Repeater, Bridges and Gateways



CAN@net NT 420  
 CAN-to-Ethernet  
 gateway/bridge with  
 2 x CAN FD, 4 x CAN



## Interconnect your CAN devices and systems

- Save costs due to simple wiring
- Increase your system reliability and protect devices by galvanic isolation (up to 4 kV)
- Backbone bus to set up multi-channel solutions
- Filter/conversion functionality – no programming!
- Bridging of large distances and easy system access using Bluetooth, Ethernet...



Discover more:  
[www.all4CAN.com](http://www.all4CAN.com)



CAN-CR120/HV  
 Repeater for CAN and CAN FD  
 (4 kV galv. iso.)



CAN-CR110/FO  
 FO repeater for CAN  
 and CAN FD



CANblue II – Bluetooth  
 PC interface, bridge, gateway



IXXAT CME/PN  
 Profinet-CANopen-Gateway



CANbridge NT  
 Bridge for  
 CAN and CAN FD

HMS Industrial Networks GmbH  
 Emmy-Noether-Str. 17 · 76131 Karlsruhe

+49 721 989777-000 · [info@hms-networks.de](mailto:info@hms-networks.de)  
[www.anybus.com](http://www.anybus.com) · [www.ixxat.com](http://www.ixxat.com) · [www.ewon.biz](http://www.ewon.biz)



# *Migration to CANopen FD or no advantage without disadvantage*



(Photo: Fotolia)

*CANopen FD, described in CiA 1301, will replace step-by-step Classic CANopen networks. Nevertheless this is not possible immediately, so that a migration is necessary.*

CAN FD will replace Classical CAN during the next years. This has several reasons. For example, the higher data throughput on CAN FD networks as well as the longer data field (payload) in the CAN FD frames. These advantages allow a more efficient transmission and are suitable for add-on protocols as well, for example, for functional security and cyber security.

Because Classical CAN controllers do not know CAN FD frames, these are destroyed by CAN error frames. The automatic repetition leads to the same result. The CAN FD frame is "killed" while the other way around it is working: On a network with CAN FD controllers, Classical CAN data frames can be dispatched without problems. The best way would be to migrate all CANopen devices to CAN FD hardware and CANopen FD software. But this is a theory. In practice most CANopen networks use devices from different manufacturers. The product cycles of these manufacturers are not well-matched to each other. Understandably.

System designers have several possibilities to integrate classic CANopen devices into CANopen FD networks. Let us take a look at their practicability.

## **About bridges and switches**

One solution is to isolate the Classic CANopen devices via a Classical CAN / CAN FD bridge. This can be a device, which passes the Classic CANopen-PDOs to the CAN FD network. If the Classical CAN identifiers must be adapted, depends on both network configurations. Indeed, one also needs a device with NMT master functionality (network management) on the Classic CANopen network.

This separation of Classic CANopen and CANopen FD devices is very adjustable. If a device with CANopen FD interface is available, it is integrated into the CAN FD segment. Otherwise it remains in the Classical CAN segment. Those "bridges" between Classical CAN and CAN FD are offered by several companies and can be partially configured in many ways. This way, even segmenting of the PDOs and recomposing is possible. There are also so-called "switches" with several Classical CAN and CAN FD ports for more sophisticated system architectures.

To be noted: two configurations are necessary. The CANopen FD devices are configured by USDO (Universal ▶

SDO) and the Classic CANopen devices in the other network segment are parameterized by SDO (service data object). Of course, both configuration functions must be coordinated, so that the overall system remains consistent. At the end of the migration all devices are available with a CANopen FD interface. The Classical CAN segment and the bridge (which is not more needed) disappear.

## Being quiet

Another idea to be able to pursue Classic CANopen devices on a CANopen FD network without error frames is to silence them before the CAN FD communication. This is possible by using CAN transceivers with selective wake-up functionality. They had been developed originally for other use cases. Some vehicle manufacturers use them to put rarely required control devices into sleep mode. This reduces the energy consumption. ECUs for power windows, sunroofs as well as parking assist systems are typical examples.

In CANopen FD networks, the Classic CANopen devices could be equipped with such transceivers. Before transmitting CAN FD frames, the devices must be in an inactive state (sleep mode) so they are not able to send error frames when CAN FD frames are sent. If the CANopen FD communication is finished, they are woken up again.

A disadvantage is that the Classic CANopen devices need other transceivers and the CANopen FD host computer takes over the sleep and wake function as specified in CiA 320. Additionally, the host computer must support CANopen FD (CiA 1301) as well as CANopen (CiA 301) so that it is able to configure all devices on the network. In Classic CANopen this ordinarily occurs via SDOs. In CANopen FD the new USDO services exist, which support a full-meshed SDO communication.

## Hiding behind shields

Another solution was already introduced a while ago, yet it isn't available on the market. NXP and also Kvaser developed CAN transceiver prototypes, which do not let pass the CAN FD frames to the CAN controllers ones. Both concepts differ in realization, but for the Classical CAN participant the result is identical. It does not see the CAN FD frames and therefore sends no CAN error frames. According to NXP, their "Shield" transceivers are available end of 2018.

But a hardware change of the existing Classic CANopen devices is still necessary. No additional management is necessary though. Also configuring CANopen devices via SDO must be solved. So, the host computer must implement a Classic CANopen and a CANopen FD protocol stack.

## Still waiting

Several protocol stack suppliers have already implemented CANopen FD. With every re-design of their devices, the manufacturers will use already CAN FD capable hardware. This concerns micro-controllers with integrated CAN FD ▷

# Industrial Ethernet Gateways/Bridges

**CAN/CANopen  
EtherCAT  
PROFINET  
CAN-to-Cloud**



**CANopen**

**PROFI  
NET**

**EtherCAT**

### CAN-EtherCAT

- Gateway between CAN/CANopen and EtherCAT
- Additional Ethernet interface for EoE

### ECX-EC

- EtherCAT slave bridge
- Process data exchange between two independent EtherCAT networks
- DC synchronization between EtherCAT masters

### CANopen-PN

- Gateway between PROFINET-IO and CANopen
- PROFINET-IRT capable
- Simple configuration via S7 manager or TIA portal

### CAN-to-Cloud

- Easy connection of CAN networks to the Microsoft Azure Cloud
- Control of CAN networks
- Control the CAN network from anywhere in the world



esd electronics gmbh  
Vahrenwalder Str. 207  
30165 Hannover  
Germany  
Tel.: +49-511-3 72 98-0  
info@esd.eu  
www.esd.eu

US office:  
esd electronics, Inc.  
70 Federal Street - Suite #2  
Greenfield, MA 01301  
Phone: 413-772-3170  
us-sales@esd-electronics.com  
www.esd-electronics.us

www.esd.eu

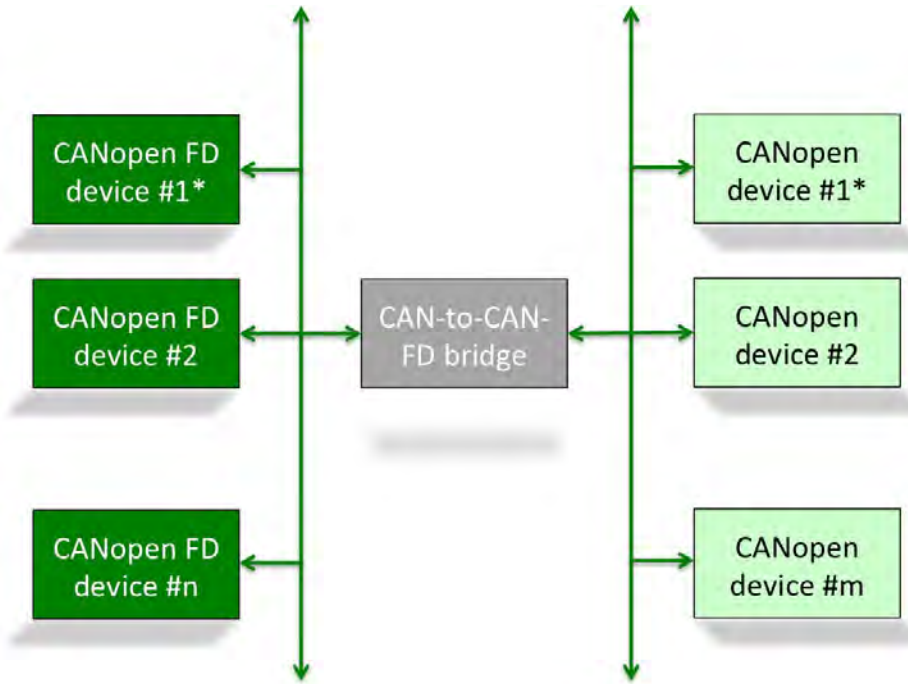

Figure 1: The subdivision on two segments (CAN FD and Classical CAN) has the advantage that the software adaptation is minimal at an incremental migration (Photo: CiA)

Users who only use own hardware can equip first all devices with CAN FD controllers and then switch over to CANopen FD. First OEMs (machine builder) are already on it. They will make all devices CAN FD capable in the future and in about two years they switch to CANopen FD.

**Conclusion**

Micro-controllers with CAN FD interfaces are already available on the market, but they are not necessarily suited for "small" industrial devices (e. g. sensors). This situation will change in the next years. For the change of Classic CANopen to CANopen FD two options are recommendable:

- ◆ Waiting till all required devices with CAN FD hardware are available and then change to CANopen FD or
- ◆ Run already available CANopen FD devices on a CAN FD network and integrate via bridge the Classic CANopen devices

CAN in Automation (CiA) offers suitable trainings (also in house seminars). Plant and machinery manufacturers who would like to migrate to CANopen FD can also use the free CiA email service to get used to the subject. Because we must live with compromises, there is also with the migration of Classic CANopen to CANopen FD no advantage without disadvantage. ◀

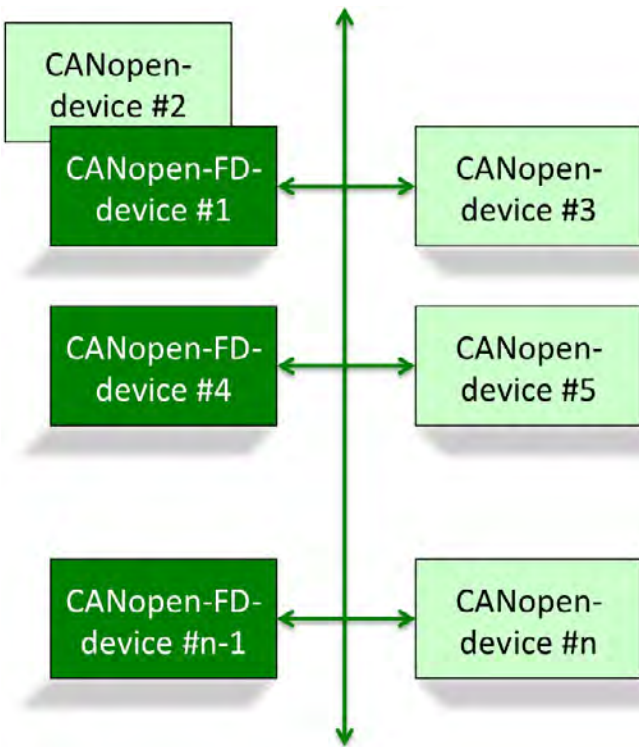

Figure 2: When using transceivers with wake-up function or shield transceivers, a hardware adaptation of the classic CANopen devices is necessary, but the software responsible for the configuration can run on a host computer (Photo: CiA)

interfaces and CAN transceivers which, are qualified for bit rates up to 5 Mbit/s. The customer decides whether they run Classic CANopen or CANopen FD on these devices. Several companies have converted the hardware already on CAN FD and it is up to the customers whether they decide for Classic CANopen or CANopen FD.

**Author**

Cindy Weissmueller  
 CAN Newsletter  
[pr@can-cia.org](mailto:pr@can-cia.org)  
[www.can-newsletter.org](http://www.can-newsletter.org)



## CAN Newsletter Online: CANOpen FD



### Protocol stack **Supports CiA 417 and CiA 1301**

The Code Generator presented by Microcontrol (Germany) facilitates definition and implementation of optimized CANOpen protocol stacks. It supports CANOpen according to CiA 417 (CANOpen Lift profile) or CiA 1301 (CANOpen FD).

[Read on](#)



### CANOpen FD **Support for all tools**

Embedded Systems Academy is now adding CANOpen FD support to all their CANOpen products. The first line of products supporting CANOpen FD is the CANOpen Magic software for the analysis and test of networks.

[Read on](#)



### Hannover Messe 2018 **Demonstrating CANOpen FD**

After some years of absence, CAN in Automation (CiA) is again part of the Hannover Messe 2018. The nonprofit association shows its CANOpen FD demonstrator.

[Read on](#)



### SPS IPC Drives 2017 **CANOpen FD protocol stack and tools**

After the release of the CANOpen FD specification CiA 1301 1.0, Emtas has announced its CANOpen FD master/slave protocol stack.

[Read on](#)



### CiA 417 application profile **CANOpen Lift plugfest and SIG meeting**

Mid of March, CiA members met to discuss the CiA 417 application profile and to test their CANOpen Lift products on interoperability.

[Read on](#)



### CiA 1301 specification **CANOpen FD application layer released**

CAN in Automation has released the version 1.0 of the CANOpen FD application layer and communication profile. CANOpen FD is based on the CAN FD data link layer.

[Read on](#)

**Flexible.  
Powerful.**

**Best all-in-one  
CAN tool.**



Hone your competitive edge with portable, durable, customizable, easily integrated Komodo™ CAN interface tools.

 **TOTAL PHASE**  
www.totalphase.com

# Security expectations versus limitations

In part 2 of this article series, we look at possible regulations for future embedded networks. What can developers of Classical CAN and CAN FD based systems do to minimize the potential impact of future regulation on their design?

If you are following technical news around the globe, you can easily get the idea that it is just a matter of time until we will have fleets of autonomously-moving vehicles of all kinds: driving, flying, swimming, or diving. Some of these will be small, like a drone to explore weather parameters or to optically check the condition of a construction. Some will be very big like a road truck or a freighter ship. Even with the intelligence needed for autonomous operation built-in, these vehicles will always need some information exchange with the outside world. At a minimum they will have a command and status interface, but more likely they will have to share plenty of information about their environment including other vehicles in their vicinity.

This data would be processed to calculate the best route to take and to coordinate the routes of all vehicles that are currently moving in the same area. For security reasons, there will likely have to be a mode to manually take over control of the vehicle by an operator in some service center if something fails and a vehicle needs to be taken out of harm's way. This could be directing a malfunctioning car off the road or finding a suitable emergency landing spot for a failing drone.

Adding more communication interfaces and command levels to such vehicles has one downside: each of these is a potential attack vector for hackers. And for hackers a target becomes more attractive the more devices there are. Just imagine there would be:

- ◆ fleets of autonomous cargo freighter ships,
- ◆ fleets of autonomous passenger cars,
- ◆ fleets of autonomous freight trucks,
- ◆ fleets of autonomous delivery drones.

Such systems attract all kinds of hackers, including those that try to extort money with ransomware, terrorists, and the “because I (think I) can” crowd. Once the first vehicle is hacked, all other vehicles using the same security methods are at risk as they share the same vulnerabilities. And before you know it, an attacker could have operating control over an entire fleet of vehicles. We predict that not before long you will see a Hollywood blockbuster movie that picks up on these scenarios. Imagine bad guys in control of a fleet of drones hunting down their victims from the air or in control of a fleet of fuel trucks slamming into buildings, all from the comfort of their own basements.

Do we believe such systems will “freely evolve” without regulation? Will politicians look the other way while these scenarios become a potential reality? Unlikely.

The only question is not if but to which extent they will regulate. As regulation is rarely crafted by engineers

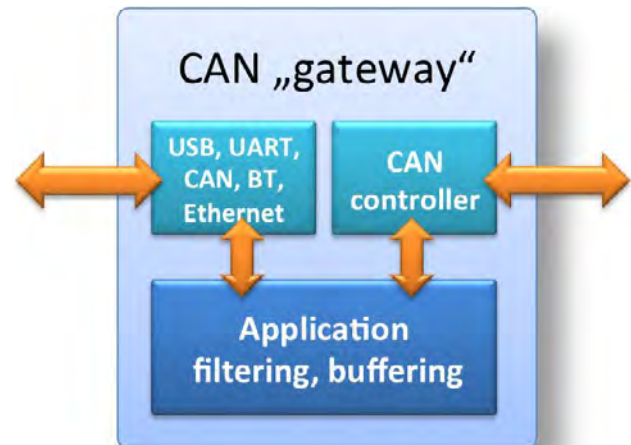

Figure 1: CAN interface, bridge, or gateway with „unlimited“ message forwarding (Photo: EmSA)

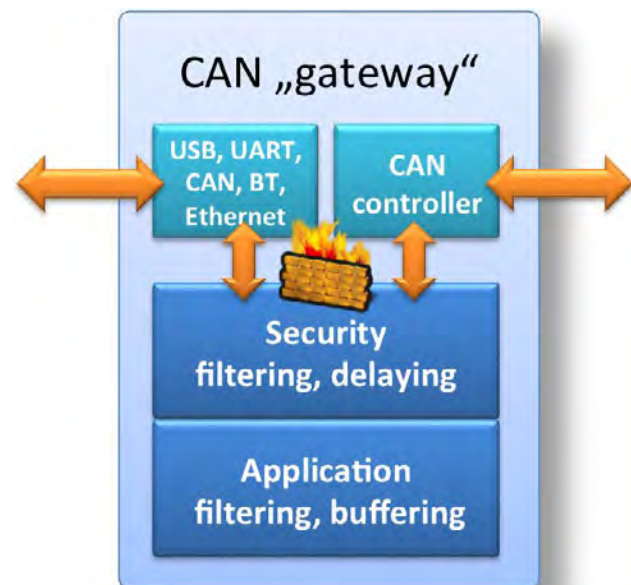

Figure 2: CAN interface, bridge, or gateway with security filtering and bandwidth control (Photo: EmSA)

with in-depth technical insight, we might end up with a law like “state-of-the-art security mechanisms must be implemented at all levels”. Great, so also a speed sensor reporting velocity data via some embedded network like CAN suddenly needs state-of-the-art security mechanisms?

## Like a sensor reporting wheel pulse counts?

Readers of our last article in this series may remember the challenges in making this signal secure from manipulation. That was only about a single sensor. Now imagine ►

implementing potentially “security at all levels” for a system with many secure devices. The complexity of the security implementation will grow by an order of magnitude and there are factors such as cost, performance, and power saving requirements that will limit what can reasonably be expected.

But even if all these systems are forced to use the best, state-of-the art security mechanisms, we have to accept that we won't reach 100 %. Best-effort will mean to only come as close as possible.

### Get into the security mindset

For a moment, think of an embedded security application like a house with locked doors and windows as the only protection against unauthorized access. Once a burglar has forced its entry and is inside the house, there are no more protection layers to stop him from also turning on the lights or using the telephone. If a hacker hacks into an embedded system where only the communication to the outside world of one device is protected, they will likely also gain access to all devices that are connected via CAN and be able to manipulate outputs and sensor data. But a house can also have multiple security layers. In an apartment house for example, access to just one apartment does not automatically give you access to the one next to it. There can be alarm systems and valuables can be hidden or locked into safes. Similarly, our future embedded systems will require security at multiple levels – within, among, and between components.

However, it still depends on the specific application how much security is needed for a particular functionality. A subnetwork in the seat of a passenger vehicle to control comfort functions like position or seat heating won't require the same level of security as the active steering component. The multiple networks in these vehicles are a good example to illustrate what we must change in our mindset for future, more secure applications. Bigger vehicles use multiple busses, some will be based on CAN (FD), others could be using LIN or some Ethernet variant. Crucial for the separation of various level of security are the interfaces, bridges, and gateways between the networks. In the past, the design for all these focused on high performance and throughput as well as reusability and flexibility. Often that meant generic, unlimited access and unlimited and transparent communication between the networks as illustrated by Figure 1.

A CAN (FD) controller or interface can typically produce any CAN message at any rate. Therefore, it can be used in some denial-of-service (DOS) style attack by producing a high-priority message back to back. Same is true for many bridges and gateways, as they are built for performance and generic use they can also pass on “unwanted” or even “dangerous” communication. This needs to change: every CAN controller, interface, bridge, and gateway needs to have some firewall component. A gateway that connects a media/entertainment/information bus to an active steering and control bus should never allow the media side to generate commands for the active steering bus. A hacker with access to the media side should therefore always face a dead end. ▶



## Kvaser Hybrid 2xCAN/LIN

### A Single, Flexible Tool For Accessing CAN & LIN



#### Coming Soon:

The NEW Kvaser Hybrid Pro 2xCAN/LIN

#### Features Include:

- ▶ **Supports High Speed CAN and LIN 2.2A up to 20 kbit/s, and CAN FD up to 5 Mbit/s.**
- ▶ **Capable of sending up to 20,000 messages per second, per CAN channel.**
- ▶ **Supplied with Kvaser CANlib and Kvaser LINlib, free software APIs.**
- ▶ **Customizable with Kvaser t Programming language.**
- ▶ **Extended operating temperature range from -40 to 85 °C.**
- ▶ **Single Shot Mode**
- ▶ **Silent Mode**

Download our Hybrid Guide at  
[www.kvaser.com/hybrid](http://www.kvaser.com/hybrid)  
or contact us at +46 31 886344  
or [sales@kvaser.com](mailto:sales@kvaser.com) to find out more.

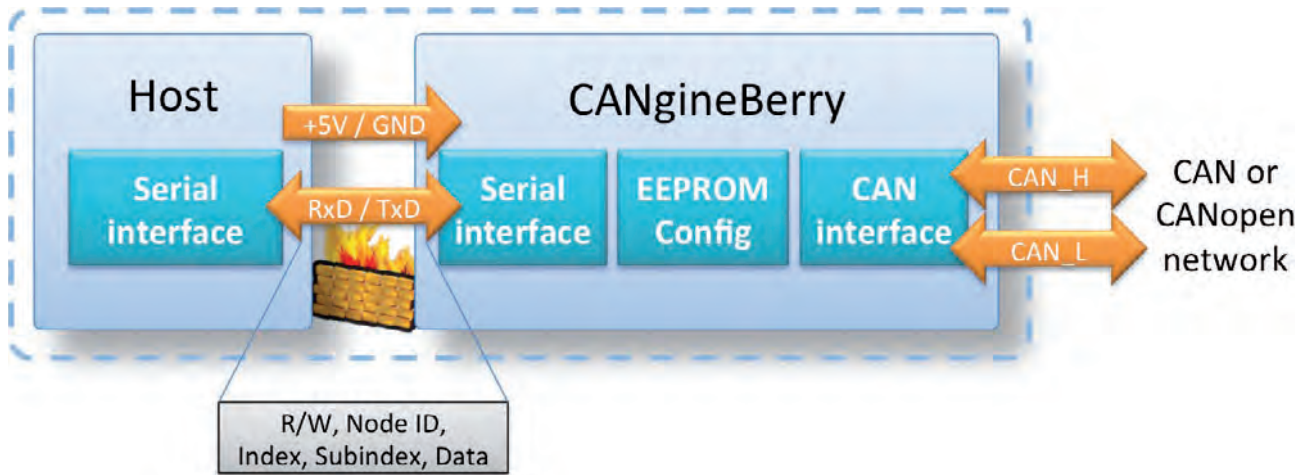

Figure 3: Physical separation: host has no CAN level access, only application data access (Photo: EmSA)

### Adding firewall components

The way CAN is currently used, any component on the network can potentially generate any message at any rate. Without further protection levels, a hacked CAN device can be used to flood a network with reset commands or to send very specific control commands. NXP recently introduced a line of smart security transceivers that partially solve this problem in hardware. Once such a transceiver is configured, it acts like a firewall and does not allow “unknown” messages to be produced. In addition, the provided flooding protection limits the bandwidth produced by transmitting frames to a configurable value.

A software solution at the CAN interface firmware level may be more practical for some systems. Imagine the firmware of such an active CAN interface would be smart enough to integrate firewall components as shown in Figure 2. When transmitting CAN messages, it only accepts “allowed” CAN message identifiers and it can also limit the transmit rate to an accepted maximum by, for example, adding a fixed delay between transmitted back-to-back messages. From such a device it would not be possible to produce a message rate occupying 100 % bus load.

To fully bypass such a system, a hacker with remote access would need to reprogram the firmware of the CAN device. A high hurdle, especially if a secure bootloader is used or the bootloader of this device can only be activated with physical access, e.g. by setting a jumper or using a special connector.

For embedded bridges and gateways with one or multiple CAN (FD) interfaces, the firewall component to add can be similar. At the lower driver level there must be both a flood protection and a filter to only allow well defined, known messages to pass. Preferably, this firewall mechanism is logically or even physically separated from the bridge and gateway configuration which is typically more easily reconfigurable and easier to hack.

Where possible, a hardware separation will provide better protection. For CANopen systems, co-processors like the CANgineberry module serve as an excellent firewall. If the communication between a host and the co-processor does not provide CAN-level but only data-level access, then even a host under total control by a hacker cannot inject arbitrary CAN messages or flood the bus.

Although these methods limit the reach of hacks and the damage that hackers can cause across networks, one issue remains. There will always be an authorized method to generate active controls – and if an attacker reaches full access to the system authorized to send control commands, and manages to keep the system intact, then there is not much else we can do on the embedded firmware side. Shielding this part of the application from the outside world as much as possible and using detection mechanisms against tampering will be essential. ◀



#### Authors

Olaf Pfeiffer  
 Christian Keydel  
 EmSA (Embedded Systems Academy)  
[info@esacademy.com](mailto:info@esacademy.com)  
[www.esacademy.de](http://www.esacademy.de)





## Decentralised signal detection and processing



### I/O module designed for mobile applications with integrated PLC

The ioControl module can either be used as a configurable I/O CAN slave in a decentralised control system or as a compact PLC in the field. The high protection rating and robust housing make it suitable for installation in wet and dirty areas of mobile machines. Programmed with CODESYS. Practical solutions for automation by ifm – close to you!



[www.ifm.com/de/en/iocontrol](http://www.ifm.com/de/en/iocontrol)  
Phone +49 800 16 16 16 4

## Tiny PLC integrated into strut profiles



*Barth has announced that its STG-800 programmable logic controller (PLC) with CANopen connectivity fits into Bosch Rexroth's 80 mm x 80 mm profiles. Of course, similar profiles by other suppliers can be used, as well.*

The tiny STG-800 extends the well-established Mini-PLC series with the smallest model coming with a powerful 32-bit Cortex core. The host controller provides a CANopen interface with NMT master functionality. It features an intuitive graphical programming capability. The ARM processor provides two high-speed event, pulse and frequency counter inputs, and one 16-bit PWM (pulse-width modulation) output combined with an internal voltage reference for the 12-bit analog inputs. The CANopen interface is able to operate in noisy environment and allows the user to connect a variety of network devices to the Mini-PLC. The STG-800 does not need any peripheral devices to operate. Both inputs and outputs features highly integrated and rugged protection circuits to operate the Mini-PLC in harsh environment.

These outstanding features open up a variety of application fields in industrial, automotive, and 12/24-V battery-powered applications. The PLC can be programmed using the graphical miCon-L software suite, Arduino IDE, or Keil MDK. It is also available as customer-tailored OEM version within eight weeks according to the supplier.

The PLC can be integrated into Bosch Rexroth's strut profiles measuring 80 mm x 80 mm. The PLC supplier also offers customer-tailored caps to integrate connectors or switches connected to the controller inside the strut profile.

Several customers use the host controller in combination with Labview. It is easy to integrate them to Labview using the CAN interface: Just use a USB/CAN dongle and the Labview driver program to interface the PLC. The host controller provides the parameters and values to be shared with the Labview software. The above-mentioned programming environments support a graphical programming.

The CANopen interface features NMT master or NMT slave capability. So CANopen motor controllers or actuators can be easily driven by PLC. The supplier provides free-of-charge C programming templates. Igus is another customer using the PLC connecting via CANopen to its own motion controllers. ◀



hz

[www.barth-elektronik.com](http://www.barth-elektronik.com)

## CAN Newsletter Online: Programmable logic controllers



Drive with PLC  
**Suitable for motors from 180 W to 4 kW**

The CFW300 variable speed drive from WEG with an integrated PLC provides optionally CANopen or Devicenet interface. The product is intended for small machines.

[Read on](#)



32-bit PLC  
**Programmable in IEC 61131-3 languages**

The K1 controller by Cannon Automata comes with an Arm Cortex-A9-based 32-bit CPU. It is suitable for universal PLC applications as well as for applications with demands on processing power and communication capability.

[Read on](#)



Multi-touch PLC  
**Awarded by Control Engineering readers**

The readers of the Control Engineering magazine have selected the Unistream PLC by Unित्रonics for the Grand Award 2018. The product provides optionally CANopen connectivity.

[Read on](#)



PLC with HMI  
**Operation, visualization, and control in one device**

NXP has developed a CAN FD transceiver with cyber security features. This includes an ID whitelist and a bus-load measuring capability.

[Read on](#)



CAN-based products  
**Controller and HMI**

The STG-8xx Mini-PLC series from Barth are integrated programmable logic controllers (PLC) providing graphical programming capability. The company's CAN Touch Display DMA-15 can be integrated as HMI in the user's CAN network.

[Read on](#)



CANopen I/O module  
**With four analog inputs**

The Hipecs-CIO57 from Frenzel + Berg is a CANopen module with four current inputs for 0-mA-to-20-mA or 4-mA-to-20-mA signals. It is designed for extensions of PLC controller systems or similar applications.

[Read on](#)

# LIN&CAN Tools for test and production

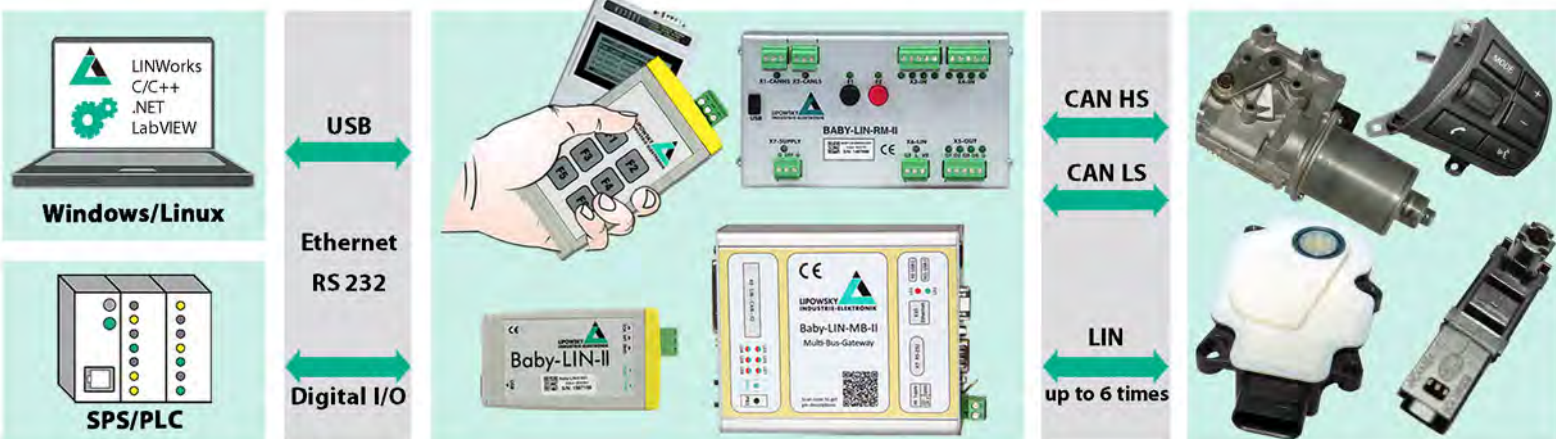

*Configure - Connect - Operate*  
*We support you all the way!*

+ 49 6151 93591-0



SINCE 1986  
ISO 9001 : 2008

[www.lipowsky.com](http://www.lipowsky.com) [info@lipowsky.de](mailto:info@lipowsky.de)

LIPOWSKY  
INDUSTRIE-ELEKTRONIK

Distribution China: Hongke Technology Co., Ltd

Ph: +86 400 999 3848

sales@hkaco.com

www.hkaco.com

Distribution USA: FEV North America Inc.

Ph: +1 248 293 1300

marketing\_fev@fev.com

www.fev.com

# Online diameter control during wire and cable production

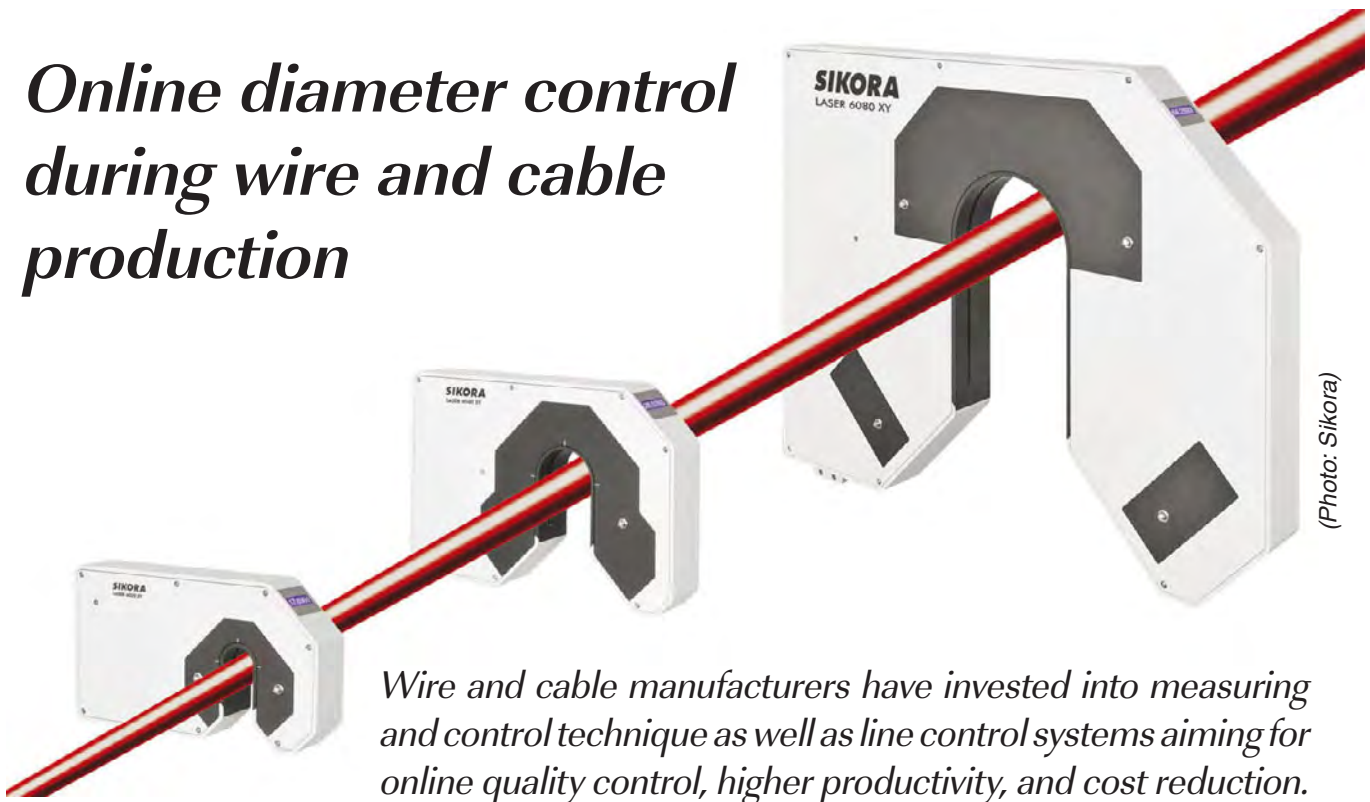

*Wire and cable manufacturers have invested into measuring and control technique as well as line control systems aiming for online quality control, higher productivity, and cost reduction.*

In 2009, Charles Kuen Kao was awarded with the Nobel Prize in Physics for his discovery that data can be sent via light through the optical fiber. In the meantime, optical transmission of data is used in many applications. Even some CAN networks are using optical fibers. Recently ISO started to standardize 150-Mbit/s Most and 1-Gbit/s Ethernet optical physical transmissions to be used in passenger cars.

Sikora offers measuring and control technology for optical fiber wire and cable production. This includes several devices coming with an optional CANopen interface. This includes measuring devices and gauge heads, which measure the outer diameter of the cable during the extrusion process. Sikora is a pioneer in the production of diameter measuring systems and developed two product series based on laser technology for continuous online quality control. Operators can choose between classic and high-end orientated technologies.

## Methods for diameter measurement

For the measurement of a product diameter there are two established techniques known. The first method was invented 40 years ago and is commonly known as "Scanning System". By using a rotating mirror, a laser beam is scanned across the measuring field onto a light sensor. In between the rotating mirror and the light sensor there are two lenses. The first lens directs the laser beam in parallel across the measuring field to the second lens. The second lens directs the laser beam onto the light sensor. The product is guided in between the two lenses and interrupts the laser beam while the laser beam is scanned across the measuring field. Thus, the diameter of the product is calculated from the time the laser beam needs to pass across the total measuring field, compared to the time the laser beam needs to run across

the product. Time is in this case equivalent to diameter. The measuring rate depends on the rotating speed of the mirror.

The technology that was presented 20 year later uses a laser beam, which is directed onto a high resolution CCD line sensor, with no rotating mirror and lenses in between (Figure 1). The product causes a shadow on the CCD line sensor. In this case the number of dark pixels on the line sensor is equivalent to the diameter. In reality the shadow evaluation is done by signal processing of the diffraction signal, resulting in most accurate readings. The measuring rate is in this case extremely high and only limited by the selected CCD line sensor.

The main differences between the two techniques are therefore that the secondly described technology is digital. It requires no moving components and no

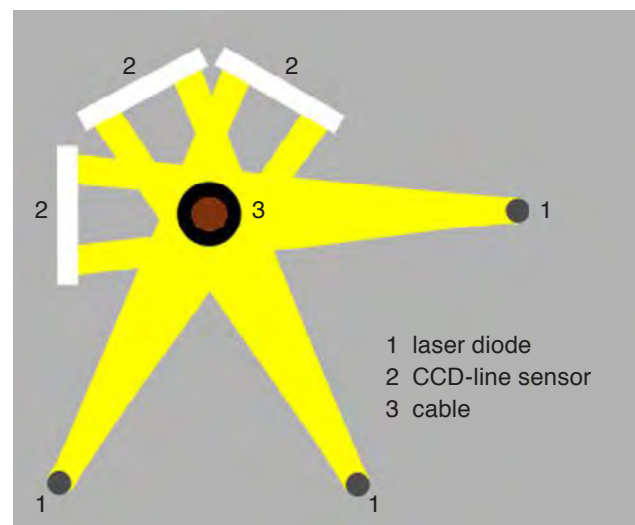

Figure 1: Measuring principle with CCD line sensors in combination with laser diodes (Photo: Sikora)

lenses. As a consequence, accuracy, repeatability, and measuring rate are higher. Calibration is not necessary.

The technological base of Sikora's diameter gauges described in the following is the second principle, using CCD-line sensor technology combined with laser diodes as light sources and powerful analysis software. There are two types of measuring heads available that meet classic respectively high-end requirements demanded for quality control at cable production lines.

### Classic diameter control

There are diameter gauges with classic functions available such as the gauge heads of the Laser Series 2000 that meet the standard requirements, which are imposed on a diameter measuring system. The gauges measure the diameter in 2 or 3 planes with a measuring rate of 500 measurements per second. Interesting is the 3-axis gauge head for defining the oval of a product. An oval is defined by five tangents. Accordingly, by using three measuring axis (six tangents on the oval) not only the min/max value of the oval, but also the orientation of the oval can be defined. All devices can be equipped with CANopen interfaces for the data transfer to a line PC or a display and control device. With an additional control module, which is integrated into the company's display and control devices, the diameter is continuously controlled to the nominal value. Customers can select from 18 types of devices covering a diameter

range from 0,05 mm to 500 mm. These devices are standard in extrusion lines today.

### High-end diameter control

Today, users are aiming for a permanent quality control of their production as well as maximum productivity and cost reduction, for instant, by using advanced innovative measuring devices. Due to this demand, Sikora has developed three diameter gauge head models of the Laser Series 6000, which meet the current high-end requirements in the wire and cable sector. Besides the classic features, which are also covered by the Laser Series 2000, the gauge heads of the Laser Series 6000 combine a variety of technological innovations to improve the productivity of extrusion lines sustainably. Up to 5000 measurements per second, each of them with highest single value precision, allow for an optimum line control and provide reliable statistical data. The high measuring rate also allows the detection of lumps and neck-downs. Therefore, the user is receiving a two-in-one system with which investment costs are being reduced and more space is achieved in the line, as the installation of only one gauge head is required. In-transparent and colored products can be measured with the Laser Series 6000 as well as transparent products. Additionally, the gauge heads have an integrated LCD display. This gives the operator the diameter value at one glance, directly at the measuring device. ▶



## CANopen SAFETY CERTIFIABLE STACK

61508

EN 50325-5

Certifiable

13849



62304

DO-178

CANopen Stack

COTS

Safety

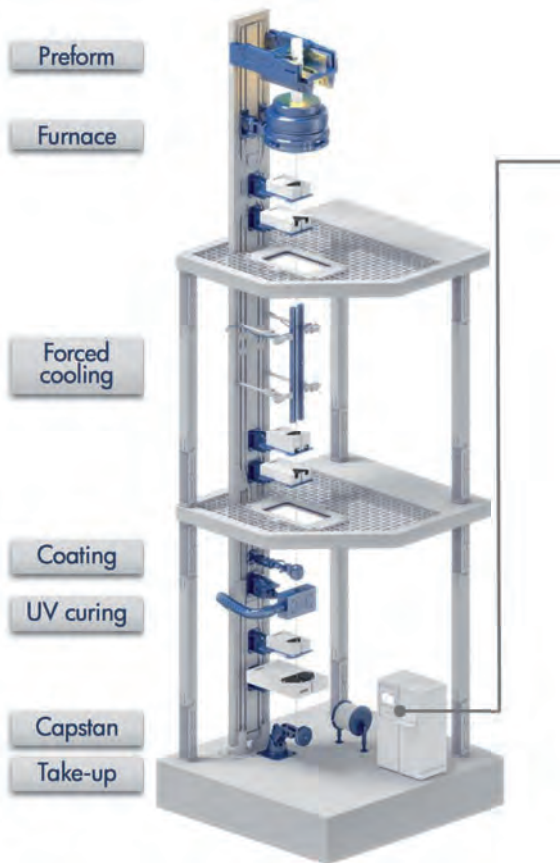

Figure 2: Fiber production measurement and control system example with different CANopen connected units (Photo: Sikora)

For applications, in which statistic data needs to be processed and stored and in which report needs to be printed, external processing systems of the Ecocontrol Series are available. Directly integrated in the gauge heads is an optional CANopen interface module. Additionally, the Laser Series 6000 has an optional Wi-Fi interface, which allows for a direct connection to a smartphone or laptop. The Wi-Fi interface is used for diagnosis and quality control and transfers measuring values, trend and statistic data, as well as video signals. The Wi-Fi interface, the interface module as well as all plug connections are completely integrated into the gauge head and, in this position, protected against water, dirt or mechanical influences during production. Furthermore, the Laser series 6000 can be used for mobile quality control: An App does not only allow the operator to display all production data at smartphones; the App also offers a gauge head calibration in accordance with ISO 9001. The values of the test probes are fed via QR Code and the measuring values are saved in a log file. For the quality management system, a test certificate is created, sent and archived.

An important feature for the integration in the production line is the swiveling gauge head design. The gauge heads can, for example for a product change, be moved-up and out of the extrusion line. All measuring heads are open at the bottom side to prevent dirt and water from falling into the measuring area. The feeding of the cable connection to the interface module is also safely protected in the gauge-head stand. Sikora offers the three diameter measuring devices for a product diameter from 0,2 mm up to 78 mm.

Ecocontrol optional CAN interface and with 15-inch touch monitor displaying the measuring values, trend recordings, online statistics

## Conclusion

The decision, which measuring and control device for quality control is being used in the production line depends on the requirements that an operator imposes on a testing device. Diameter measuring devices have to control the quality continuously during production. They provide

actual information about the product and therewith the basis for automatic control. Ultimately, only the combination of the gauge head and the control device contribute to cost reduction during production. The diameter is automatically controlled to the minimum value based on the measuring results and the comparison with the nominal value. Hence, there is only as much material used as currently required. In this way, costs can be reduced, scrap avoided, and the productivity is increased significantly.

The Laser Series 2000, in combination with a line PC or control device, offers classic technology features, which enable the operator to react quickly to tolerance deviations and to produce optimum quality. The Laser Series 6000 is additionally equipped with various advanced features, with which the users can run their production lines more efficiently. Especially the extremely high measuring rate, measuring accuracy and repeatability are setting new standards in the precise controlling of the production line and, therewith, for the production of cables of high quality. ◀

hz  
[www.sikora.net](http://www.sikora.net)

## CAN Newsletter Online: Optical fiber

The CAN Newsletter Online reports briefly about products and services regarding CAN.



Measurement system

### ***Used in Formuler E racing***

Isabellenhuetten's IVT-F shunt-based measurement system is used in race cars of the FIA Formuler E. For the communication between the system and battery control unit, a CAN interface is used.

[Read on](#)



CAN control panel

### ***Two multi-purpose rotor loading wagons***

Poettinger has added two models to its Combiline series of multi-purpose rotor loading wagons. The Torro 7010 and Torro 8010. Its control panels are connected to a CAN network.

[Read on](#)



Military electronics

### ***CAN is increasingly used in army, navy, and air force***

Already since many years, Cots (commercial off-the-shelf) technologies are used in military equipment. CAN is one of them.

[Read on](#)



Digital service

### ***Trailer data to the cloud***

Mercedes-Benz' Uptime is an integral solution detecting driving-relevant repair and maintenance scope of hitched-up trailers. It collects trailer data available in the CAN-based in-vehicle networks.

[Read on](#)



Drive controller

### ***The invisible lift car door opener***

The Swiss elevator manufacturer, Schindler, and Maxon Motor also located in Switzerland have developed jointly a CAN-connectable drive system that moves the car lift doors.

[Read on](#)



Theater and event locations

### ***CAN on and behind the stage***

Since many years, Zub Machine Control, a daughter company of Maxon, has supplied theater and stage control systems. In many cases, CANOpen-connectable drives are integrated.

[Read on](#)



Sea-level simulator

### ***CANopen inverter drives the 1,7-m impellers***

ABB has equipped the circular wave and tidal current test facility located at the University of Edinburgh's King's Buildings campus. This includes CANOpen-connectable inverters.

[Read on](#)



# YOUR LINK TO THE WORLD OF MODERN AUTOMATION - X90

[www.br-automation.com/mobile-automation/](http://www.br-automation.com/mobile-automation/)

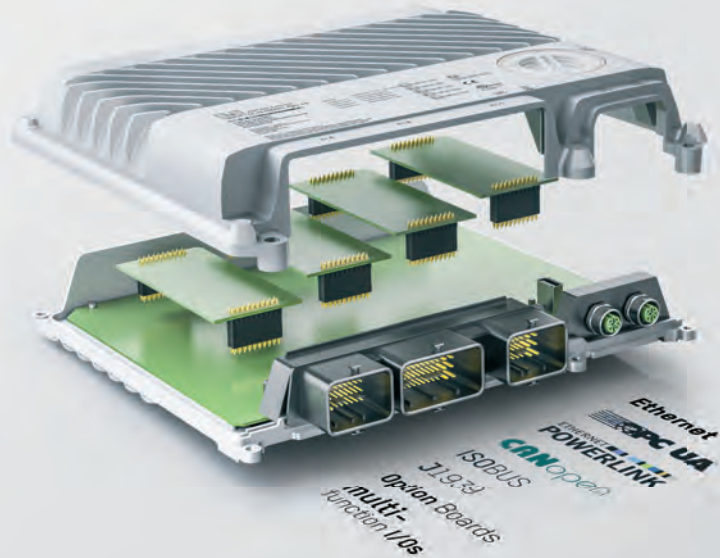

- Scalable hardware platform
- Preprogrammed software components
- 3-times faster development

PERFECTION IN AUTOMATION  
A MEMBER OF THE ABB GROUP



# Self-configuring CANopen controller

An approach to further simplify using CANopen devices by providing a self-configuring, minimal, easy-to-use CANopen Manager and NMT master.

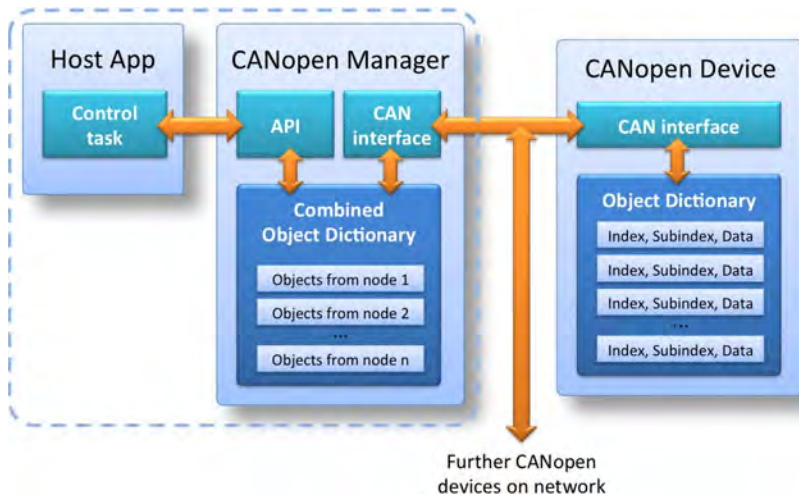

Figure 1: The typical setup - All data objects from all connected devices are combined in the manager's Object Dictionary (Photo: EmSA)

For newcomers to CANopen, the initial hurdle to write a control program for a CANopen system has been relatively high. A system integrator must often go through a lengthy CANopen configuration process. In CANopen, all devices have a unique node ID and a local Object Dictionary containing all parameters that can be communicated. The Object Dictionary entries are addressed by an Index and Subindex value, similar to a lookup table. The manual of a CANopen slave device will typically list and document all available Object Dictionary entries (= parameters).

To successfully connect CANopen NMT slave devices to a network, you need to configure many of them first. Since this is typically the CANopen manager's duty, you need to configure it accordingly as well. This may include a PDO (Process Data Objects) mapping process. Using EDS (Electronic Data Sheet) files, the CANopen Manager learns about these settings and provides local object dictionary entries for every parameter that can then be accessed by the control program.

Figure 1 illustrates the typical setup: all data objects from all connected devices are combined in the manager's Object Dictionary. In

many applications this means that the Index and Subindex values for the data objects change. A parameter that is at Object Dictionary entry [6200 01<sub>n</sub>] in a CANopen slave device might be placed at a location like [2002 01<sub>n</sub>] in the Manager. These re-arrangements can be quite confusing. Also, to access any data objects not part of PDOs, a host would have to access the CANopen Manager's SDO manager function to use SDO read or write cycles. This is part of the CANopen standard, but not straightforward to use in practice.

In contrast, the CANopen knowledge required to write a control program with the new CANopenIA-MGR by EmSA is minimal: All parameters of all slave devices can be immediately

accessed without having to know their location in the manager.

This is illustrated in Figure 2. The Manager's local Object Dictionary is no longer used to mirror process data from the slave devices. Instead, the host application can directly reference the Index and Subindex values as used in the slave devices.

With this knowledge, one can start writing a CANopen control program. All data coming in from the CANopen devices is passed on to the control program with the parameters source node ID, source index and subindex. No need ▶

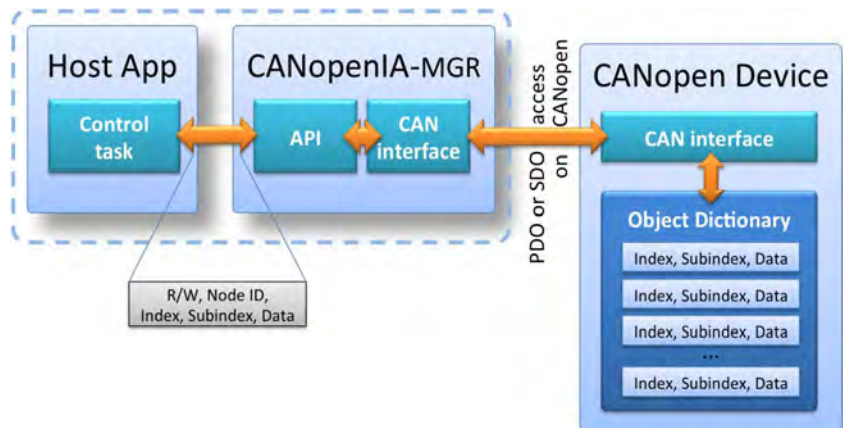

Figure 2: Read or write request to a remote Object Dictionary of a node on the network (Photo: EmSA)



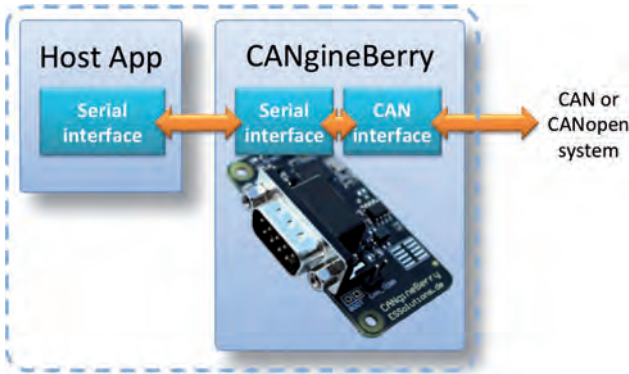

Figure 3: Stand-alone versions of the CANopen Manager communicated to the host via UART (Photo: EmSA)

to consider any “mapping”, just receive the data along with the information from which node it comes and which parameter it is. The same concept is used for sending data to the CANopen devices. The control program simply passes the destination node ID and the destination Index and Subindex with the data on to the CANopenIA-MGR process. The CANopenIA-MGR then decides automatically which communication method (for those who know these details: PDO or SDO) is best used to transmit the data.

A generic read and write from the host to all slaves is also possible at all times. All parameters transmitted through PDOs are locally buffered whereas for those not in PDOs, the manager automatically creates the necessary SDO read or write access to the slave devices. This self-configuring CANopen controller scans the network on every power-up to learn all PDO mappings from all slave devices. While this adds a delay of a few seconds on every power-up, this ensures that the controller always makes sure that its internal PDO configuration matches the devices connected to the network.

It also informs the host application about important system events. These include Bootup of nodes, Heartbeat activation or loss, Emergency messages and others. It keeps a local copy of each identification object, so device type and vendor ID can be quickly accessed without generating additional traffic on the CANopen network.

The self-configuring CANopen controller is currently available as a library or dedicated hardware: as a Windows DLL (Dynamic Link Library) for PCAN interfaces from Peak System or as CANgineberry, an active CAN/CANopen module for the Raspberry Pi or other embedded host computers.

The CANgineberry addresses the shortcomings of many “CAN shields” that are passive, have no own intelligence, and require the host computer to handle all CAN communication message by message. In worst case, a CAN system can have more than ten thousand individual messages per second. Sometimes the real-time requirements are below 10 ms for some responses which is difficult to achieve with a Linux or Windows based host and a passive approach. The communication to the host system uses a regular serial channel (TTL-UART), so no special driver is required as UART support is typically part of all operating systems. The CANopenIA-MGR firmware

is included with the CANgineberry delivery and can handle up to 32 CANopen devices.

The CANopen Controller Library for PCAN interfaces of Peak-System can handle up to 127 devices. It is a Windows DLL and therefore the timing accuracy and response time greatly depends on the host system and its tasks. However, there are many CANopen control applications where occasional delays of a few tens of milliseconds are perfectly acceptable. Programming examples are provided for C++ and Javascript, examples for other programming languages are available upon request. ◀



**Author**

Olaf Pfeiffer  
 EmSA (Embedded Systems Academy)  
[info@esacademy.com](mailto:info@esacademy.com)  
[www.esacademy.de](http://www.esacademy.de)



*CAN in Automation*

The non-profit CiA organization promotes CAN and CAN FD, develops CAN FD recommendations and CANopen specifications, and supports other CAN-based higher-layer protocols.

## *Join the community!*

- ▶ Initiate and influence CiA specifications
- ▶ Receive information on new CAN technology and market trends
- ▶ Have access to all CiA technical documents also in work draft status
- ▶ Participate in joint marketing activities
- ▶ Exchange knowledge and experience with other CiA members
- ▶ Get the CANopen vendor-ID free-of-charge
- ▶ Get credits on CANopen product certifications
- ▶ Get credits on CiA training and education events
- ▶ Benefit from social networking with other CiA members
- ▶ Get credits on advertisements in CiA publications

*For more details please contact CiA office  
at [headquarters@can-cia.org](mailto:headquarters@can-cia.org)*

*[www.can-cia.org](http://www.can-cia.org)*