

Improved CAN-driver: How CAN-driver configuration can improve the signal integrity in a starshaped CAN-bus

Kent Lennartsson, Kvaser AB

Limitations in data communication bandwidth are caused by the layout of the CAN-bus. This is a general description and is valid for any communication cable with more than two devices connected to a common transmission line, such as CAN, LIN and 10BASE-T1S. All technology is evolved from point-to-point communication, where energy comes from a source at one end and is absorbed at the other. For a multidrop installation where devices are connected along the transmission line, the source can be anywhere along the line, whilst any other device can be the receiver. To absorb the energy, two terminations are placed at the furthest ends of the cable layout and all connected receivers will reflect the energy back to the CAN-bus. The best way to prevent oscillation is to use as low a slew-rate as possible.

TDR Analysis on a real CAN-bus

To understand the electrical effects of a complex CAN-bus layout, it is necessary to understand what's happening from a point-to-point communication point of view. Figure 1 shows a CAN-bus where all drop lines are removed to obtain a simple point-to-point transmission line. There are two common measurements required to analyze a transmission line: TDR (Time Domain Reflectometer [2]) to check the impedance, and frequency response for the S-parameters.

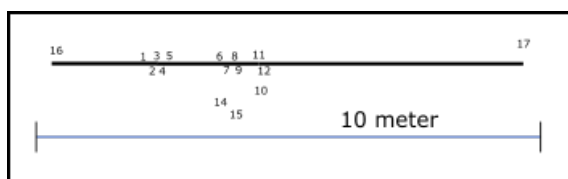

Figure 1: A 9.6 meter long cable

Figure 2 is achieved by placing the TDR tool at location 16 in figure 1. The first connection point (1 to 5 in figure 1) shows a drop in impedance to 87 Ohm after 2.4 meters. After another 1.6 meters comes the next connection point (6 to 12 on the diagram) and the second impedance drop. The cable ends at 17 without any termination and the impedance jumps to infinity. The distance at the cursor (1) in figure 2 is

9.6 meters. The measurement is conducted in delay time, whilst distance is calculated with an assumed wave speed of 4.7 ns/meter, or 70% of the speed of light. The signal delay from 16 to 17 in figure 1 is in the range of 45 to 50 ns (see figure 15).

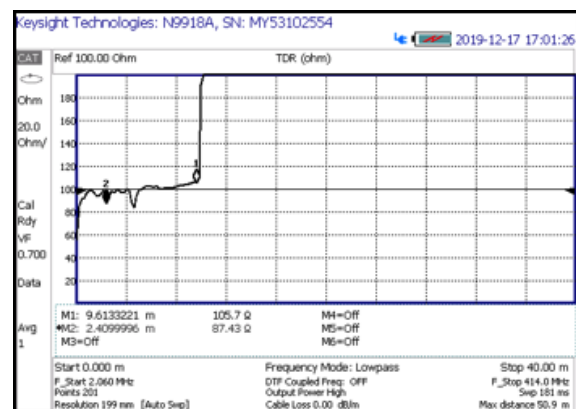

Figure 2: Impedance measured using TDR connected at point 16 in figure 1. Cursor 1 is at the end of the cable at location 17.

The two impedance drops are caused by the small T-connectors without any drop lines connected. With well-designed CAN-drivers installed directly at the T-connector device, it would be possible to achieve communication far in excess of 20 Mbit/s on this short CAN-bus.

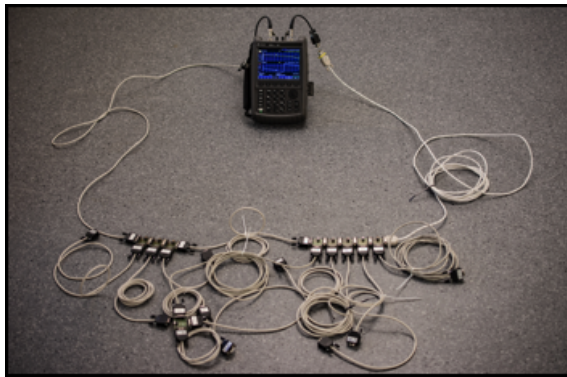

Figure 3: Shows the TDR measurement, with all drop lines installed

A closer study of figure 2 shows that the impedance starts out at 50 Ohm, which is the standard impedance in most instruments for analyzing signals. The connection to the instrument is done with 0.2 meters of 50 Ohm coax cable with a 9-pin DSUB that matches the DSUB connected to the end of the CAT5 cable (point 16 in figure 1). A CAT5 cable is designed to have a characteristic impedance of 100 Ohm, matching the level in figure 2.

By adding cables to the T-connectors it is possible to see the effects of drop lines. Below is a table with the length of all cable segments.

Table 1: List of cable segments and their length in meters.

Segment	Length in meters
16 - 1	2.1
2	1.3
3	1.9
4	1.85
5 - 6	1.6
7 - 13	3.0
8	1.4
9	3.9
10	1.0
11 - 17	3.0
12	5.2
14	0.8
15	1.0

In the first test, only the short drop lines - points 2, 8, 10, 14 and 15 in figure 1 - are installed. Even those short drop lines have a great effect on the impedance, as seen in Figure 4.

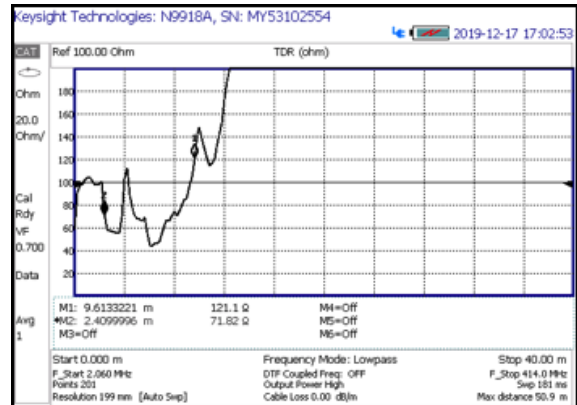

Figure 4: Impedance with short drop lines at points 2, 8, 10, 14 and 15 installed

The impedance remains at 100 Ohm in the first cable segment (16 – 1), but at the first T-connector, a drop to 60 Ohm can be witnessed due to the 1.3-meter-long drop line in cable segment 2. The measurement shows some higher impedance until it reaches the next section with T-connectors, where the impedance drops to 40 Ohm. It should also be observed that at the cable end, the TDR shows a sloped line to infinity, rather than a vertical line to infinity: the star shaped cable prevents the TDR from measuring the cable end as it should.

The impedance with all segments installed is shown in figure 5. The impedance value in figures 4 and 5 are beyond what is measurable using a generic TDR tool.

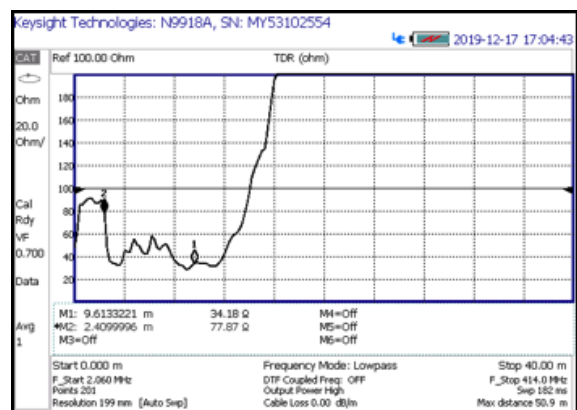

Figure 5: TDR measurement of the CAN-bus shown in Figures 6 and 3

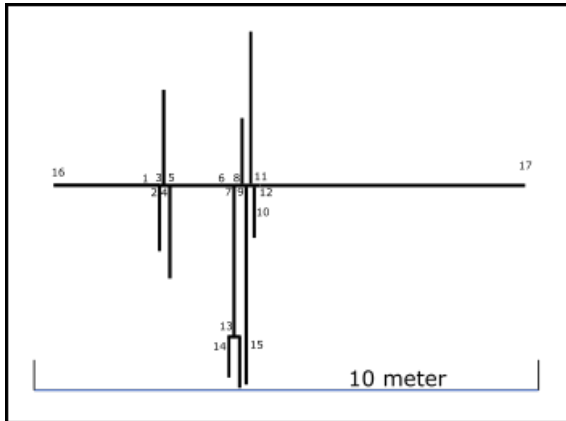

Figure 6: The complex cable layout drawing as shown in figure 3, with cable segments as listed in Table 1

A TDR measurement tool is designed to find small impedance variations found in a point-to-point cable. In a more complex cable layout, as shown in Figure 6, it is necessary to use other tools to understand the limitations.

S-parameter analysis on a real CAN-bus

If the impedance variation is too large, high speed data communications will be prevented. To understand the bit-rate limitation, it is necessary to check the frequency response and from that, estimate the maximum bandwidth.

This is achieved by measuring the S12 parameters from the sender to the receiver. A complete comparison with the previous TDR measurement would necessitate S12 measurements from each sender and receiver, so a bus with 11 ECUs would need 110 measurement points in total. However, it is possible to measure just a few points in order to find out the worst-case frequency limits.

The first measurement is done on the point- to-point cable as shown in figure 1. The source is located at 16 at one end of the CAN-bus cable and the receiver is at the other end. The S12 tool will send energy with different frequencies at location 16, and the same tool will measure how much of this energy reaches location 17.

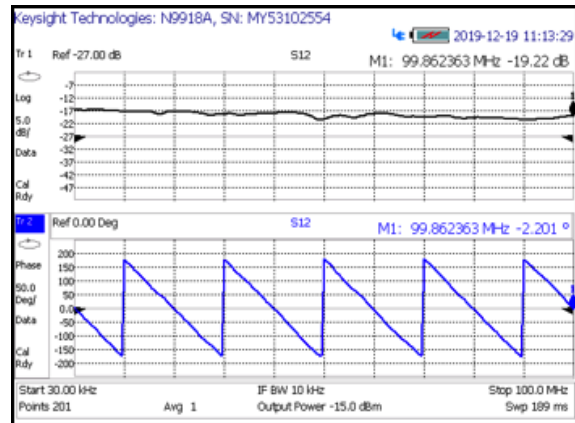

Figure 7: S12 from source at 16 to receiver at 17, from 0 to 100 MHz with CAN-bus layout as shown in figure 1

The upper graph in figure 7 shows the loss. The energy drop is only 1 to 2 dB up to 45 MHz. Beyond 45 to 95 MHz, some frequencies drop to almost 4 dB. A 3 dB loss equates to half the input voltage. 2 Volt at input will be about 1 Volt at 50 MHz in this cable layout.

The lower graph in figure 7 shows the phase shift between connections 16 and 17. At low frequency, the phase shift is zero and at 20 MHz it is 360 degrees, which equates to one whole wavelength. The cycle time at 20 MHz is the inverse of this value, which is 50 ns. If 50 ns is divided by the length of the cable, we get roughly 5 ns per meter. At 100 MHz we have 5 full cycles between connection 16 to 17.

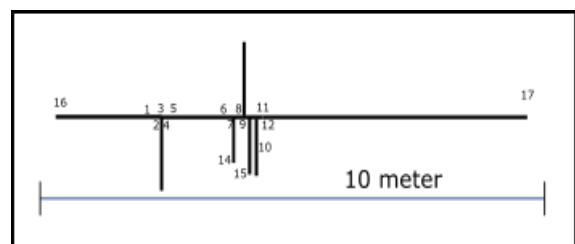

Figure 8: A 9.6-meter CAN-bus with 5 short drop lines

The next step is to install the short stubs 2, 8, 10, 14 and 15 as shown in figure 8.

The result from the S12 measurement after installing the drop lines is shown in figure 9.

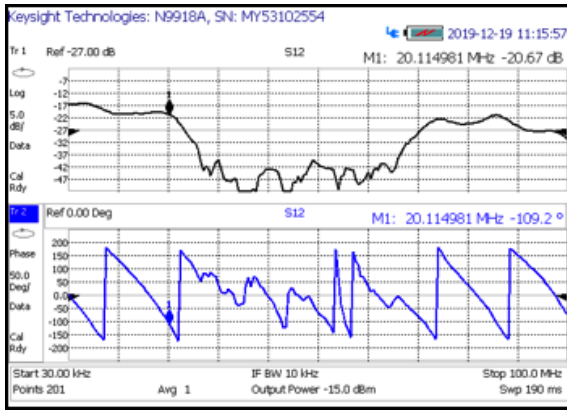

Figure 9: The S12 parameters from the source at 16 to receiver at 17 (with figure 8 CAN-bus layout) for all frequencies from 0 to 100 MHz. Upper graph shows loss in dB; lower shows phase shift

The cursor in figure 9 is at 20 MHz and this is the 3-dB limit (the point at which signal voltage drops to 50% of the transmitted level). The CAN-bus blocks all frequencies from 20 to 75 MHz. The frequencies from 75 to 100 MHz are 10 dB lower than the input level at connection 16, but are not completely blocked.

The phase diagram should not change very much, but when the signal level is low, there will be increased measurement uncertainty.

The next step is to install all drop lines as shown in figure 6. The result of the S12 measurement on this system from connection 16 to 17 is shown in figure 10.

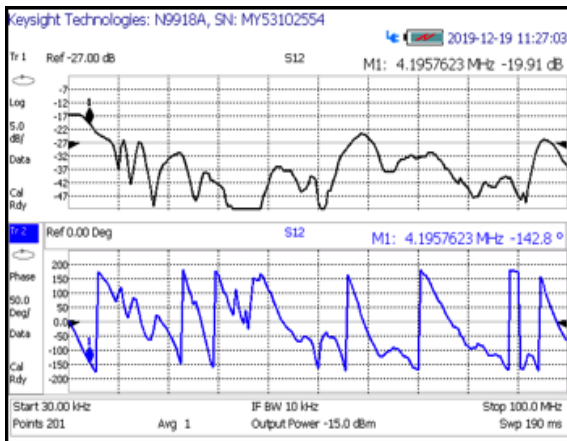

Figure 10: S12 from source at 16 to receiver at 17 from 0 to 100 MHz with CAN-bus as shown in figure 6

With the complex CAN-bus as shown in figure 6, a 3-dB limit has already materialized at 4 MHz. As seen in figure 10, it is impossible to transfer energy above 4 MHz from connection 16 to 17. To achieve a better resolution, the measurement in figure 10 is repeated in figure 11 with the frequency range set from 0 to 20 MHz.

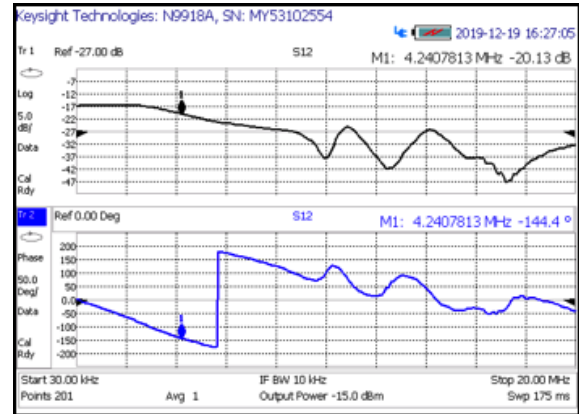

Figure 11: Same as figure 10, but with a frequency range of 0 to 20 MHz

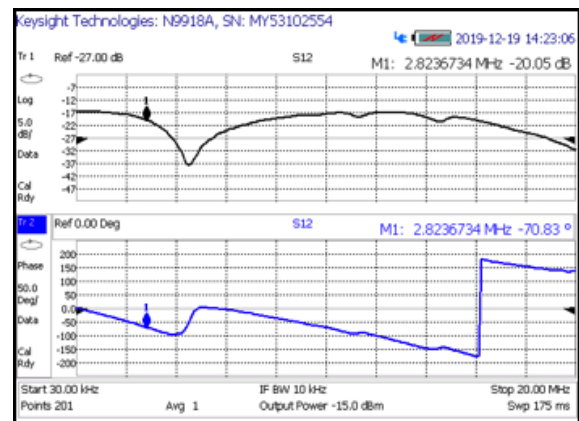

Figure 12: S12 from 16 to end of segment 2, frequency range 0 to 20 MHz

Figure 10 shows the analog bandwidth between connections 16 and 17. If you repeat this measurement from 16 to all other drop line ends there will be similar but differing results. The connection 16 to 17 has the highest analog bandwidth at 4.2 MHz. The lowest bandwidth is between point 16 and the end of drop line number 2 (segment 2 in table 1), with the lowest analog bandwidth registering at 2.8 Mhz. To check all possible scenarios, it is necessary to move the sender to all different connections and repeat this measurement for all possible receivers.

The relation between analog bandwidth and bit-rate.

Data communication is all about energy transfer over a transmission line. The analog bandwidth defines the highest sinus signal within a certain frequency that can transfer energy over the transmission line. A digital signal is more similar to a square wave. A CAN-frame transmitted at 500 kBit/s is similar to a square signal at 250 kHz. A cyclic signal can be transformed into the frequency spectrum by a Fourier transformation.

$$Squarewave(t) = \frac{4}{\pi} * \sum_{n=1,3,5..}^{\infty} \frac{Amp}{n} * \sin(n * \pi * t)$$

From this information, it is possible to make a list of the frequencies and their amplitudes, that combined, will be shaped like a square wave. Below is the table for the 250 kHz square wave.

Table 2: The first 6 elements in the Fourier transformation of a 250 kHz square wave

Peak	n	Freq kHz	Amp	Amp =1	Power
1	1	250	$\frac{4 * Amp}{(\pi * 1)}$	1.27	1.61
2	3	750	$\frac{4 * Amp}{(\pi * 3)}$	0.42	0.18
3	5	1250	$\frac{4 * Amp}{(\pi * 5)}$	0.25	0.06
4	7	1750	$\frac{4 * Amp}{(\pi * 7)}$	0.18	0.03
5	9	2250	$\frac{4 * Amp}{(\pi * 9)}$	0.14	0.02
6	11	2750	$\frac{4 * Amp}{(\pi * 11)}$	0.11	0.01

If we connect a square wave generator at the connection 16 and measure the spectrum at connection 17, the result will be as shown in figure 13.

The first peak is 250 kHz at -12 dB and the second peak is 750 kHz at -21.6 dB. By taking the power from the first two peaks it is possible to calculate the difference in dB. The 10log(0.18/1.61) gives an expected

-9.6 dB lower value for the 750 kHz peak. By taking the dB value for the first peak (-12 dB) and subtracting with this calculated value (- 9.6 dB) you get the expected level -21.6 dB as seen for the 750 kHz peak in figure 13.

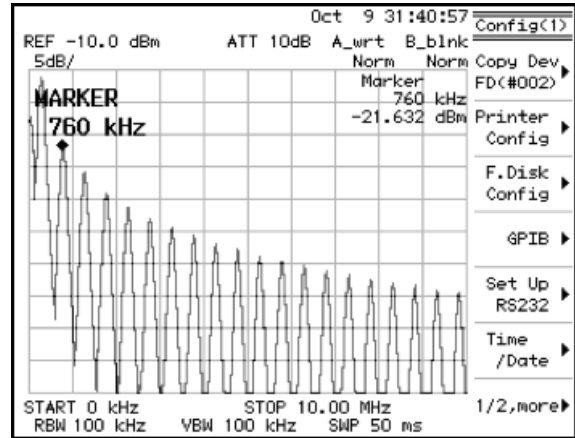

Figure 13: Spectrum for a square wave at 250 kHz with a 5 ns slew-rate

As seen in figure 13 the energy is spread from 250 kHz and all the way up to 10 MHz and beyond. The simple solution to reduce energy at higher frequencies is to reduce the slew rate. Figure 14 shows the spectrum with the same square wave but with 200 ns slew-rate instead of 5 ns.

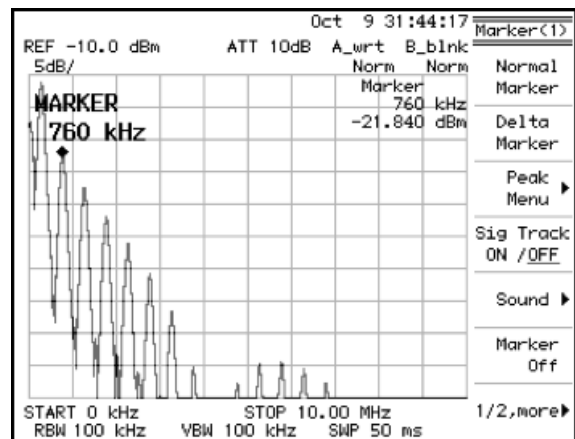

Figure 14: Spectrum for a square wave at 250 kHz with a 200 ns slew-rate

As shown in figure 14, the dB level on the first two peaks is identical for 5 or 200 ns slew rate. All the other peaks are lower and there is almost no energy above 3 MHz. Figure 15 and 16 show the analog signal at connection 16 and 17 at the two different slew-rates.

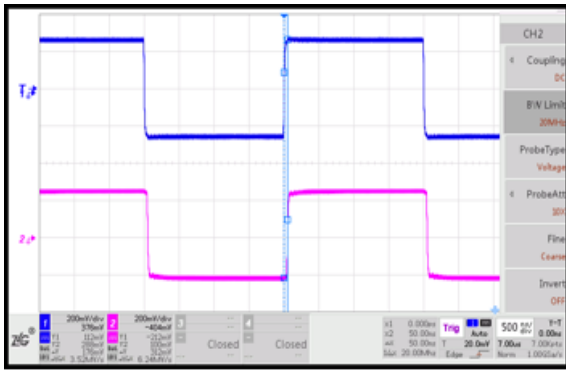

Figure 15: Top signal at connection 16 and lower signal at connection 17, in figure 1. 250 kHz with 5 ns slew-rate

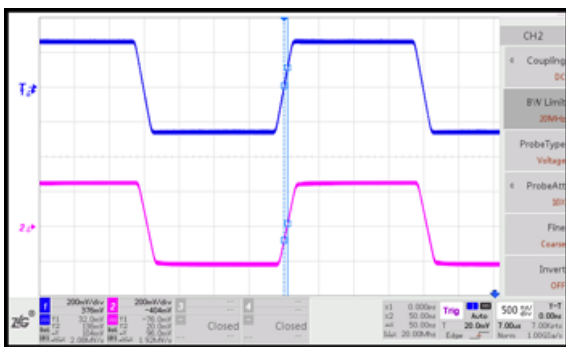

Figure 16: Top signal at connection 16 and lower signal at connection 17 in figure 1. 250 kHz with 200 ns slew-rate

This simple point-to-point cable has no problem handling a high slew rate, and the CAN-bus layout in figure 1 has no problem handling 25 Mbit/s. As shown in the TDR and S12 measurements, much lower bandwidth is to be expected from the more complex cable layout shown in figure 6. Figure 17 shows the analog signal at 250 kHz (500 kBit/s) with 5 ns slew rate and all drop lines connected as shown in figure 6.

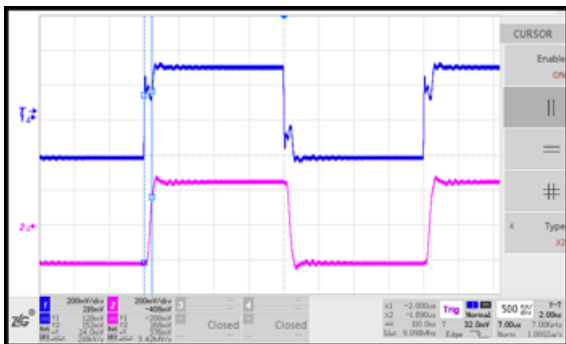

Figure 17: Top signal at connection 16 and lower signal at connection 17 in figure 6. 250 kHz with 5 ns slew-rate

As seen in figure 17, there is an LP-filter which limits the higher frequencies to reach connection 17 in figure 6. The expected signal delay at 50 ns as seen in figure 15 becomes 110 ns in figure 17. There is also a lot of high frequency ripple in the signal. The simple solution to remove the high frequency energy is to reduce the slew-rate. Figure 18 shows the result when slew-rate is reduced from 5ns to 200 ns. The measurement shown in figure 18 on the CAN-bus layout in figure 6 is almost identical to the measurement in figure 16 on the point-to-point CAN-bus shown in figure 1. It should be noted that the edge delay is also back to 50 ns, because there is no high frequency energy to be absorbed.

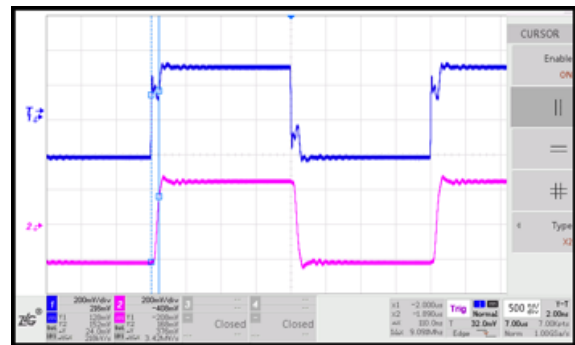

Figure 18: Top signal at connection 16 and lower signal at connection 17 in figure 6. 250 kHz with 200 ns slew-rate.

CAN-bus signaling

The previous description is signal theory for transmission of energy on a CAN-bus layout with different quantities of droplines, at different lengths and with different distributions. All those measurements are carried out with a signal source and receiver that is impedance matched to the transmission line. A CAN-driver is not impedance matched to the transmission line. CAN use a CAN-signaling according to the ISO 11898-2 specification, which do not comply to the standard measurement method. As a transmitter, it behaves as a low impedance voltage source, and as a receiver, it behaves as a high impedance connection point, requiring that all energy is absorbed in the termination resistors. This means that the signal will be slightly different when standard CAN-drivers are used for the signaling.

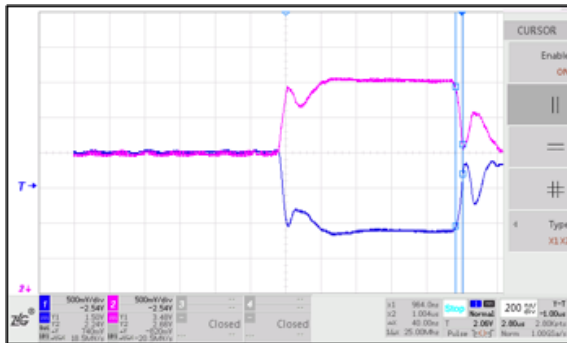

Figure 19: Dominant signal at connection 17 for the worst transmitter

Figure 19 shows the worst signal forming a dominant bit from the transmitter when measured at the ending point 17, as shown in figure 6. There is negative reflection at the dominant edge causing a signal drop after 100 ns, but the signal becomes stable after 250 ns. It is little worse at the Recessive edge where the positive reflection is relatively large.

Figure 20 is identical to figure 19, but in this case, the bit-rate has changed from 1 Mbit/s to 0.5 Mbit/s. The length of the CAN-bit will increase when the bit-rate is reduced but the edges will not change because the shape of the edges are only affected by the slew-rate, not the bit-rate. The reason is that during low bitrates such as 1 Mbit/s, the CAN-bits are so long that the signal should be considered a DC-level. If the CAN-bits become shorter than 250 ns, energy will transfer from one edge to the next edge. So, any bitrate above 4 Mbit/s will modify the shape of the edges and the signal has to be treated as an AC-signal. The cable delay is 50 ns and all reflections back to measurement point 17 are returned after 100 ns, and after another 100 ns the system is almost on a stable level.

The cursors in figure 20 show that the slew-rate at the recessive edge is 40 ns. At 500 kBit/s the CAN-bit is 2000 ns long and it would be no problem to increase the slew-rate from 40 ns to 200 ns, with the impact being that all oscillation at the edges would disappear. This ringing at the recessive edge is not a real problem for the CAN-communication because any extra recessive edges are ignored by the CAN-controller.

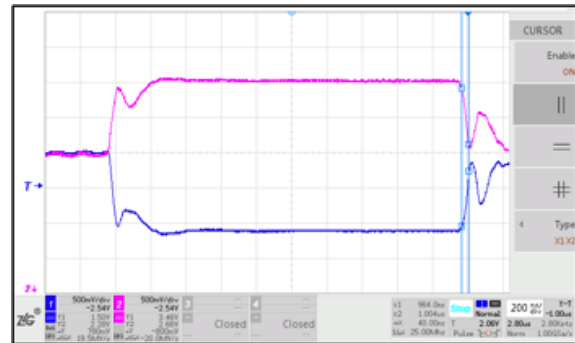

Figure 20: Dominant signal at connection 17 for the worst transmitter at 500 kBit/s.

Figure 19 and 20 show a single CAN-bit. Figure 21 and 22 show the same measurement over multiple CAN-bits by setting the oscilloscope in persist mode. Figure 19 shows the signal at 1 Mbit/s. The signal with clear colors in figure 19 is the most common shape. There is also a signal with a higher amplitude that begins early and starts with a spread in time. This is the ACK-bit, which has a higher amplitude because it is sent by all receivers concurrently. The spread in the dominant edge of the ACK-bit is due to the fact that all the receivers will start relative to the internal synchronization to the received CAN-frame, which is delayed by the CAN-driver and the cable distance. The ACK-bit has a large over-shoot because energy is sent from many sources, adding up to a high voltage at the edge.

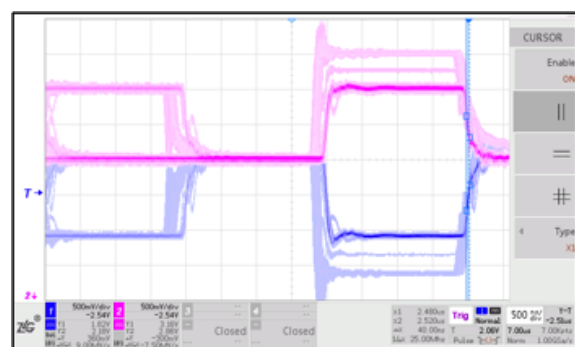

Figure 21: Dominant signal at connection 17 at 1 Mbit/s with oscilloscope in persist mode.

Figure 22 shows almost the same signal shape as in figure 21. In this case there is two levels between the CAN-frame level and the ACK-bit level. This is the arbitration level where 2, and 2+ senders are sending the CAN-ID concurrently.

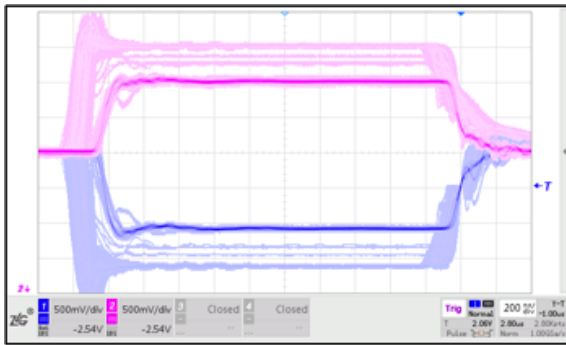

Figure 22: Dominant signal at connection 17 at 0.5 Mbit/s with oscilloscope in persist mode.

This arbitration level will also exist at 1 Mbit/s, but with the same number of CAN-frames per second, arbitration is less common. The level becomes a little higher, but not as high as the ACK-bit sent by all receivers. There is also a slightly larger spread in the start of the ACK-bit, caused by using twice as long Time Quanta at 500 Kbit/s. Using the same TQ-length at 500 Kbit/s will provide an edge shape that is similar to 1Mbit/s.

Conclusion

The best way to improve the CAN-bus signal is to use a cable layout with the shortest possible drop lines. If that is not possible, it is necessary to educate yourself to understand the problem and the limitation that is set by your cable layout.

The most important issue for achieving good signal quality is to optimize the slew-rate to the actual cable layout. Slew-rate adjustment is supported by most CAN-drivers, but it demands use of an adjustable/replaceable resistor (current). This is a suitable solution in a mass-produced machine with a fixed number of ECUs and cable layout.

The ideal solution would be to use CAN-drivers that allow configuration of the slew-rate to the bitrate and the actual cable layout.

Try to avoid capacitors and inductors between the CAN-driver and the CAN-bus wires. Chokes are useful to remove unbalanced current and high frequencies from the CAN-driver. A better solution is to

prevent this problem up front by selecting the right CAN-driver with slew-rate adjustment and the ability to match the current between CANH and CANL.

More knowledge

It should be quite easy to understand that reduced slew-rate will also reduce the high frequency oscillation. High frequency handling and theory demands complex knowledge, and/or a good RF-engineer. I have found two books helpful for explaining the physics and math for transmission lines. This knowledge is also good when routing PCB with high speed digital signals like PCIeExpress and DRAM.

For an engineer, the book “Signal Integrity Simplified” [1] is highly recommended. It contains many examples to help you gain an intuitive understanding of the high-speed signal. The author, Eric Bogatin, has made many educational videos too. These can be found at:

<https://go.teledynelecroy.com/l/48392/2019-10-10/7spn52>

or <https://bethesignal.com/bogatin/>.

The other book that I recommend is “High Speed Signal Propagation: Advanced Black Magic” by Drs. Howard Johnson and Martin Graham [2]. This is more theoretical and a little harder to read but covers material that is not described in Bogatin’s book.

Kent Lennartsson
Kvaser AB
Aminogatan 25A
SE-43153 Mölndal
www.kvaser.com

References

- [1] Signal Integrity Simplified, ISBN 0-13-066946-6
- [2] High Speed Signal Propagation: Advanced Black Magic, ISBN 0-13-084408-X
- [3] Keysight N9918A, with Network Analyzer and CAT.